

Oracle Rdb™ for OpenVMS

Oracle RMU™ Reference Manual

Release 7.2

ORACLE®

Oracle RMU Reference Manual

Release 7.2

Copyright © 1991, 2006 Oracle Corporation. All rights reserved.

The Programs (which include both the software and documentation) contain proprietary information of Oracle Corporation; they are provided under a license agreement containing restrictions on use and disclosure and are also protected by copyright, patent, and other intellectual and industrial property laws. Reverse engineering, disassembly, or decompilation of the programs is prohibited.

The information contained in this document is subject to change without notice. If you find any problems in the documentation, please report them to us in writing. Oracle Corporation does not warrant that this document is error free. Except as may be expressly permitted in your license agreement for these Programs, no part of these Programs may be reproduced or transmitted in any form or by any means, electronic or mechanical, for any purpose, without the express written permission of Oracle Corporation.

If the Programs are delivered to the U.S. Government or anyone licensing or using the programs on behalf of the U.S. Government, the following notice is applicable:

U.S. GOVERNMENT RIGHTS Programs, software, databases, and related documentation and technical data delivered to U.S. Government customers are “commercial computer software” or “commercial technical data” pursuant to the applicable Federal Acquisition Regulation and agency-specific supplemental regulations. As such, use, duplication, disclosure, modification, and adaptation of the Programs, including documentation and technical data, shall be subject to the licensing restrictions set forth in the applicable Oracle license agreement, and, to the extent applicable, the additional rights set forth in FAR 52.227-19, Commercial Computer Software—Restricted Rights (June 1987). Oracle Corporation, 500 Oracle Parkway, Redwood City, CA 94065.

The Programs are not intended for use in any nuclear, aviation, mass transit, medical, or other inherently dangerous applications. It shall be the licensee’s responsibility to take all appropriate fail-safe, backup, redundancy and other measures to ensure the safe use of such applications if the Programs are used for such purposes, and Oracle Corporation disclaims liability for any damages caused by such use of the Programs.

Oracle is a registered trademark, and SQL*Plus, Hot Standby, Oracle CODASYL DBMS, Oracle Rdb, Oracle RMU, and Rdb are trademarks or registered trademarks of Oracle Corporation. Other names may be trademarks of their respective owners.

The Programs may provide links to Web sites and access to content, products, and services from third parties. Oracle is not responsible for the availability of, or any content provided on, third-party Web sites. You bear all risks associated with the use of such content. If you choose to purchase any products or services from a third party, the relationship is directly between you and the third party. Oracle is not responsible for: (a) the quality of third-party products or services, or (b) fulfilling any of the terms of the agreement with the third party, including delivery of products or services and warranty obligations related to purchased products or services. Oracle is not responsible for any loss or damage of any sort that you may incur from dealing with any third party.

Contents

Send Us Your Comments	ix
Preface	xi
1 Oracle RMU Command Syntax	
1.1 Command Parameters	1-1
1.2 Command Qualifiers	1-2
1.3 Using Indirect Command Files	1-3
1.4 Required Privileges for Oracle RMU Commands	1-4
1.5 RMU Alter Command	1-11
1.6 RMU Analyze Command	1-13
1.7 RMU Analyze Cardinality Command	1-22
1.8 RMU Analyze Indexes Command	1-28
1.9 RMU Analyze Placement Command	1-39
1.10 RMU Backup Command	1-47
1.11 RMU Backup After_Journal Command	1-95
1.12 RMU Backup Plan Command	1-127
1.13 RMU Checkpoint Command	1-131
1.14 RMU Close Command	1-134
1.15 RMU Collect Optimizer_Statistics Command	1-140
1.16 RMU Convert Command	1-155
1.17 RMU Copy_Database Command	1-165
1.18 RMU Delete Optimizer_Statistics Command	1-184
1.19 RMU Dump Command	1-188
1.20 RMU Dump After_Journal Command	1-199
1.21 RMU Dump Backup_File Command	1-213
1.22 RMU Dump Export Command	1-224
1.23 RMU Dump Recovery_Journal Command	1-226
1.24 RMU Dump Row_Cache Command	1-228
1.25 RMU Extract Command	1-231
1.26 RMU Insert Optimizer_Statistics Command	1-272

1.27	RMU Librarian Command	1-277
1.28	RMU Load Command	1-280
1.29	RMU Load Plan Command	1-331
1.30	RMU Monitor Reopen_Log Command	1-337
1.31	RMU Monitor Start Command	1-339
1.32	RMU Monitor Stop Command	1-343
1.33	RMU Move_Area Command	1-346
1.34	RMU Open Command	1-362
1.35	RMU Optimize After_Journal Command	1-369
1.36	RMU Populate_Cache Command	1-386
1.37	RMU Reclaim Command	1-389
1.38	RMU Recover Command	1-391
1.39	RMU Recover Resolve Command	1-411
1.40	RMU Repair Command	1-415
1.41	RMU Resolve Command	1-426
1.42	RMU Restore Command	1-430
1.43	RMU Restore Only_Root Command	1-477
1.44	RMU Server After_Journal Reopen_Output Command	1-507
1.45	RMU Server After_Journal Start Command	1-509
1.46	RMU Server After_Journal Stop Command	1-511
1.47	RMU Server Backup_Journal Resume Command	1-513
1.48	RMU Server Backup_Journal Suspend Command	1-515
1.49	RMU Server Record_Cache Checkpoint Command	1-518
1.50	RMU Set After_Journal Command	1-520
1.51	RMU Set Audit Command	1-539
1.52	RMU Set Buffer_Object Command	1-554
1.53	RMU Set Corrupt_Pages Command	1-557
1.54	RMU Set Galaxy Command	1-563
1.55	RMU Set Global_Buffers Command	1-565
1.56	RMU Set Logminer Command	1-567
1.57	RMU Set Privilege Command	1-569
1.58	RMU Set Row_Cache Command	1-582
1.59	RMU Set Server Command	1-587
1.60	RMU Set Shared_Memory Command	1-590
1.61	RMU Show Command	1-593
1.61.1	RMU Show After_Journal Command	1-594
1.61.2	RMU Show Audit Command	1-604
1.61.3	RMU Show Corrupt_Pages Command	1-609
1.61.4	RMU Show Locks Command	1-611
1.61.5	RMU Show Logical_Names Command	1-629
1.61.6	RMU Show Optimizer_Statistics Command	1-631
1.61.7	RMU Show Privilege Command	1-638
1.61.8	RMU Show Statistics Command	1-641

1.61.9	RMU Show System Command	1-667
1.61.10	RMU Show Users Command	1-669
1.61.11	RMU Show Version Command	1-672
1.62	RMU Unload Command	1-676
1.63	RMU Unload After_Journal Command	1-702
1.64	RMU Verify Command	1-738

2 RdbALTER Utility Command Syntax

2.1	AREA . . . PAGE Command	2-4
2.2	ATTACH Command	2-6
2.3	COMMIT Command	2-8
2.4	DEPOSIT Command	2-9
2.5	DEPOSIT FILE Command	2-15
2.6	DEPOSIT ROOT Command	2-17
2.7	DETACH Command	2-19
2.8	DISPLAY Command	2-20
2.9	DISPLAY FILE Command	2-27
2.10	DISPLAY ROOT Command	2-29
2.11	EXIT Command	2-31
2.12	HELP Command	2-33
2.13	LOG Command	2-34
2.14	MAKE CONSISTENT Command	2-35
2.15	MOVE Command	2-37
2.16	NOLOG Command	2-38
2.17	PAGE Command	2-39
2.18	RADIX Command	2-40
2.19	ROLLBACK Command	2-41
2.20	UNCORRUPT Command	2-42
2.21	VERIFY Command	2-44

A RMU Load Record Definition File Language

A.1	DEFINE FIELD statement	A-1
A.2	DEFINE RECORD Statement	A-2
A.2.1	Usage Notes	A-3
A.3	Additional Data Types	A-4
A.3.1	Date-Time Syntax	A-7

B Using LogMiner for Rdb

B.1	Restrictions and Limitations with LogMiner for Rdb	B-2
B.2	Information Returned by LogMiner for Rdb	B-3
B.3	Record Definition Prefix for LogMiner Fields	B-5
B.4	SQL Table Definition Prefix for LogMiner Fields	B-6
B.5	Segmented String Columns	B-6
B.6	Using LogMiner to Minimize Application Downtime for Maintenance	B-6
B.7	Using an OpenVMS Pipe	B-8

Index

Figures

1	A Sample Syntax Diagram	xiv
1-1	Output from the RMU Show After_Journal Command	1-595
A-1	DEFINE FIELD Statement	A-2
A-2	DEFINE RECORD Statement	A-3
A-3	Data Types	A-5

Tables

1-1	Privileges Required for Oracle RMU Commands	1-5
1-2	RMU\$FLAGS Bits Used by the RMU Analyze Indexes Command	1-35
1-3	RMU\$FLAGS Bits Used by the RMU Analyze Placement Command	1-45
1-4	RMU Backup Options	1-50
1-5	How Tapes are Relabeled During a Backup Operation	1-84
1-6	Statistics Gathered by the RMU Collect Optimizer_Statistics Command	1-142
1-7	System Tables Used to Store Optimizer Statistics	1-149
1-8	RMU Dump Command Header Options	1-190
1-9	Parameters for Generated Command File	1-241
1-10	Using Qualifiers to Determine Output Selection	1-253
1-11	Data Type Conversions Performed by Oracle Rdb	1-285
1-12	Columns in a Database Table for Storing Security Audit Journal Records	1-306
1-13	DACCESS Privileges for Database Objects	1-542
1-14	Buffer Object Control	1-555

1-15	Server Types and Logical Names	1-588
1-16	Lock Qualifier Combinations	1-612
1-17	RESOURCE_TYPE Keywords	1-617
1-18	Lock Mode Compatibility	1-620
1-19	Output Fields	1-707
1-20	Commit Record Contents	1-711
1-21	Parameter Record Contents	1-715
A-1	Character sets supported by Oracle RMU Load	A-6
B-1	Output Fields	B-4

Send Us Your Comments

Oracle Rdb for OpenVMS Oracle RMU Reference Manual, Release 7.2

Oracle Corporation welcomes your comments and suggestions on the quality and usefulness of this publication. Your input is an important part of the information used for revision.

- Did you find any errors?
- Is the information clearly presented?
- Do you need more information? If so, where?
- Are the examples correct? Do you need more examples?
- What features did you like most?

If you find any errors or have any other suggestions for improvement, please indicate the document title, chapter, section, and page number (if available). You can send comments to us in the following ways:

- Electronic mail: nedc-doc_us@oracle.com
- FAX — 603-897-3825 Attn: Oracle Rdb
- Postal service:
Oracle Corporation
Oracle Rdb Documentation
One Oracle Drive
Nashua, NH 03062-2804
USA

If you would like a reply, please give your name, address, telephone number, and (optionally) electronic mail address.

If you have problems with the software, please contact your local Oracle Support Services.

Preface

Purpose of This Manual

Oracle Rdb is a general-purpose database management system based on the relational database model. Oracle RMU, the Oracle Rdb management utility, is the portion of Oracle Rdb that you can use to perform database maintenance tasks, and monitor and display information about Oracle Rdb databases.

This manual provides the syntax, semantics, and reference material for Oracle RMU through release 7.2.

Intended Audience

To use this manual effectively, you should be familiar with data processing procedures, basic database management concepts and terminology, and the OpenVMS operating system.

Structure

This manual contains two chapters, two appendixes, and an index, as follows:

Chapter 1	Describes the syntax and semantics of Oracle RMU commands. Oracle RMU commands allow you to display information about, monitor, and manage Oracle Rdb databases.
Chapter 2	Describes the syntax and semantics of the RMU/ALTER commands available in the RdbALTER utility.
Appendix A	Describes the syntax generated for specially formatted output files (.rrd files) by some Oracle RMU commands.
Appendix B	Describes how to use the LogMiner for Rdb feature.

Oracle RMU Command Syntax Diagrams

This manual uses the following conventions to present the syntax of Oracle RMU commands:

- Oracle RMU commands and qualifiers appear in initial capitals. Commands and qualifiers can be entered in upper-, lower-, or mixed-case type.
- Command parameters and variables are represented in lowercase type. These format elements represent parameters or variables for which you must supply a value.
- Horizontal ellipsis points (. . .) mean you can enter additional information, such as parameters or qualifier arguments.
- Brackets ([]) enclose optional clauses from which you can choose one or none.
- A comma (,) separating qualifier arguments means you can specify one or more arguments with the qualifier.
- A vertical bar (|) separating qualifier arguments in syntax diagrams means you can specify only one argument with the qualifier.

For example, the following is the format for the RMU Analyze Placement command:

```
RMU/Analyze/Placement root-file-spec [index-name[,...]]
```

The Analyze command and the Placement qualifier can be entered as upper-, lower-, or mixed-case type. The root-file-spec parameter indicates that you must supply a root file specification. The index-name enclosed in brackets (and followed by a comma and ellipses in brackets) indicates that you can supply one or more index-names, separated by commas.

RdbAlter Syntax Diagrams

This manual uses syntax diagrams to graphically present the syntax of RdbAlter statements. Syntax diagrams portray optional, required, and repeating characteristics of any Oracle Rdb statement. You can learn the syntax of a command by reading that command's syntax diagram.

To read a syntax diagram, start from the left and follow the arrows until you exit from the diagram at the right. When you come to a branch in the path, choose the branch that contains the option you want. If you want to omit an option, choose the path with no language elements. If a diagram occupies

more than one horizontal line, the arrow returns to the left margin. Syntax diagrams can contain:

- Names of syntax diagrams

If a diagram is named, the name appears in lowercase type above and to the left of the diagram. Syntax diagrams can refer to each other by name. The equal sign (=) indicates that the name is equivalent to the diagram and that the diagram can be substituted wherever the name appears.

If the diagram contains the name of another diagram, substitute that other diagram where the name appears. Such a substitution is similar to putting the name of a field where “field-name” appears. Most named syntax diagrams appear as subdiagrams following the main diagram.

- Keywords

Keywords appear in uppercase type. If a keyword is underlined, you must include it in the command. A keyword without underlining is optional, but the keyword makes the command more readable. Omitting an optional keyword does not change the meaning of a command.

- Punctuation marks

Punctuation marks are included in the diagram when required by the syntax of the command.

- User-supplied elements

User-supplied elements appear in lowercase type. These elements can include names, expressions, and literals. They are usually defined in text following the diagram.

Figure 1 shows a portion of the syntax diagram for the `RdbALTER DISPLAY` command.

Figure 1 A Sample Syntax Diagram

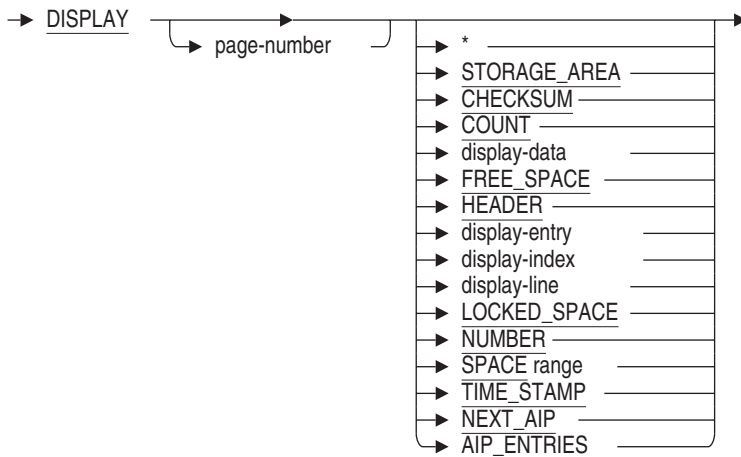

display-data =

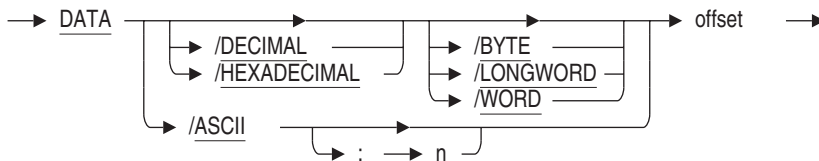

- DISPLAY Is in uppercase and underlined on the main line of the diagram. Therefore, you must supply the keyword (which can usually be abbreviated).
- page-number Is in lowercase on a branch of the diagram. Therefore, the page-number clause is optional; if you include it, you must supply a substitute for page-number.
- display-data Is in lowercase on a branch. Because it parallels an empty branch, the display-data clause is optional. The subdiagram expands the definition of display-data.

Conventions

OpenVMS means both the OpenVMS Alpha and OpenVMS I64 operating systems.

In this manual, Oracle Rdb refers to Oracle Rdb for OpenVMS. Version 7.2 of Oracle Rdb software is often referred to as V7.2.

The SQL interface to Oracle Rdb is referred to as SQL. This interface is the Oracle Rdb implementation of the SQL standard adopted in 1999. This standard is referred to as the ANSI/ISO SQL standard or SQL:1999. See the Oracle Rdb Release Notes for more information.

Oracle CDD/Repository software is referred to as the dictionary, the data dictionary, or the repository.

In examples, an implied carriage return occurs at the end of each line, unless otherwise noted. You must press the Return key at the end of a line of input.

The following conventions are also used in this manual:

.	Vertical ellipsis points in an example mean that information not directly related to the example has been omitted.
:	
:	
...	Horizontal ellipsis points in statements or commands mean that parts of the statement or command not directly related to the example have been omitted.
e, f, t	Index entries in the printed manual may have a lowercase e, f, or t following the page number; the e, f, or t is a reference to the example, figure, or table, respectively, on that page.
[]	In format descriptions, brackets enclose optional clauses from which you can choose one or none. In a prompt, brackets indicate that the enclosed item is the default response. For example, [y] means the default response is Yes.
{ }	Braces in format descriptions enclose clauses from which you must choose at least one.
\$	The dollar sign represents the DIGITAL Command Language prompt in OpenVMS.
boldface text	Boldface type in text indicates a term defined in the text, the glossary, or in both locations.
⇒	This symbol indicates that you choose a menu item.
<u>menu name</u>	An underlined character in a menu name indicates a mnemonic key you can use as an alternative to the mouse.

Oracle RMU Command Syntax

Oracle RMU, the Oracle Rdb management utility, lets database administrators manage Oracle Rdb databases. Oracle RMU commands are executed at the operating system prompt. Oracle RMU command syntax follows the rules and conventions of the DIGITAL Command Language (DCL).

Oracle RMU commands allow you to display the contents of database files, control the Oracle Rdb monitor process, verify data structures, perform maintenance tasks (such as backup and restore operations), and list information about current database users and database activity statistics.

Oracle RMU commands consist of words, generally verbs, that have parameters and qualifiers to define the action to be performed.

1.1 Command Parameters

One or more spaces separate command parameters and their qualifiers from the command keyword. Command parameters define the file, index, or entity on which the command will act. In most cases, you can omit the parameter from the command line and enter it in response to a prompt.

In the following sample command, RMU/DUMP is the command keyword and MF_PERSONNEL is the command parameter:

```
$ RMU/DUMP MF_PERSONNEL
```

When a storage area is a command parameter in an Oracle RMU command, use the *storage area name* instead of the *storage area file specification*. For example:

```
$ RMU/RESTORE/AREA MF_PERSONNEL.RBF EMPIDS_LOW/THRESHOLDS=(65,75,80)
```

Some commands, such as the RMU Backup command, require two or more command parameters. If you provide all parameters (for example, a root file specification and a backup file name), there are no prompts. Other commands, such as the RMU Restore command, have one required and one optional command parameter. In this case, there are no prompts if you provide the

backup parameter but not the storage area parameter. However, if you do not provide either parameter, Oracle RMU prompts for both.

1.2 Command Qualifiers

Command qualifiers modify the behavior of an Oracle RMU command. Although similar in appearance, command qualifiers are different from the Oracle RMU commands themselves. The first (and sometimes the subsequent) word that follows the RMU keyword is the command itself. For instance, in the following example, `/DUMP` and `/AFTER_JOURNAL` are part of the Oracle RMU command and thus must appear in the order shown. `/OPTION=STATISTICS` and `/LOG` are command qualifiers and can appear in any order after the Oracle RMU command. You can determine which portions of an Oracle RMU command are the command itself, and which portions are command qualifiers by noting the documented name of the command,

```
$ RMU/DUMP/AFTER_JOURNAL aij_one.ajj /OPTION=STATISTICS/LOG
```

Command qualifiers can be entered as upper-, lower-, or mixed-case type. They always begin with a slash (/) followed by a qualifier word.

In some cases, an equal sign (=) and a qualifier value follow the qualifier word. A qualifier value can be simple (a number, a string, or a keyword) or compound (a list of numbers, strings, or keywords separated by commas, enclosed in parentheses) or an indirect command file name. For information on using indirect command files, see Section 1.3.

A default value for a qualifier indicates what qualifier will be used if you omit the qualifier completely. Omitting a qualifier is not the same thing as specifying a qualifier with a default argument.

Command qualifiers influence the overall action of a command. Command qualifiers must be placed following the command keyword but before any parameters.

In the following example, the command qualifier, `Users`, immediately follows the `Dump` keyword and precedes the command parameter, `mf_personnel`:

```
$ RMU/DUMP/USERS MF_PERSONNEL
```

Parameter qualifiers (also referred to as file qualifiers or area qualifiers) affect the treatment of parameters in the command. If the command includes multiple instances of a given type of parameter, the placement of parameter qualifiers affects their scope of influence as follows:

- If you position the parameter qualifier after a particular parameter, the qualifier affects only that parameter. This is *local* use of a parameter qualifier.

- If you position the parameter qualifier before the first parameter, the qualifier applies to all instances of the parameter. This is *global* use of a parameter qualifier. Not all parameter qualifiers can be used globally. To identify such qualifiers, read the description of the qualifier.
- If you position the parameter qualifier after a parameter, the qualifier applies only to that instance of the parameter. Local parameter qualifiers take precedence over global parameter qualifiers, in most cases. Exceptions are documented in the qualifier descriptions for each Oracle RMU command.

The following example demonstrates the local use of the area qualifier, `Thresholds`, to change the threshold settings for the `EMPIDS_LOW` area:

```
$ RMU/RESTORE MF_PERSONNEL EMPIDS_LOW/THRESHOLDS=(70,80,90)
```

Note that if you specify a qualifier in both the negative and positive forms, the last occurrence of the qualifier is the one that takes effect. For example, the `NOLOG` qualifier takes effect in this command:

```
$ RMU/BACKUP/LOG/NOLOG MF_PERSONNEL MF_PERS
```

This is consistent with DCL behavior for negative and positive qualifiers.

1.3 Using Indirect Command Files

Numerous Oracle RMU command operations accept lists of names as values for certain qualifiers, such as the `Areas=` or `Lareas=` qualifiers. The command syntax can easily exceed the maximum length of 1024 characters accepted by DCL. To overcome the problem of syntax that is too long, you can include the names in an indirect command file and specify the indirect command file following the qualifier. Throughout this manual, this is commonly referred to as using an indirect file reference. Note that indirect command files can be nested to any depth.

Each indirect command file (default file extension `.opt`) contains a list of names with one name per line. A comment, preceded by an exclamation point, can be appended to a name, or it can be inserted between lines. A reference to an indirect command file in the list must be preceded by an at sign (`@`) and enclosed in quotation marks (`"`). For example: `"@EMPIDS"`.

The following example shows the contents of an indirect command file called `empids.opt`. It lists the `EMPIDS_LOW`, `EMPIDS_MID`, and `EMPIDS_OVER` storage areas. The last line in the example shows how you would reference the indirect command file in an Oracle RMU command line with the required quotation marks.

```

$ TYPE EMPIDS.OPT
  EMPIDS_LOW      ! Employee Areas
  EMPIDS_MID
  EMPIDS_OVER
$ RMU/ANALYZE/AREA="@EMPIDS" MF_PERSONNEL ! ANALYZE EMPLOYEE AREAS

```

1.4 Required Privileges for Oracle RMU Commands

An access control list (ACL) is created by default on the root file of each Oracle Rdb database. To be able to use a particular Oracle RMU command for the database, you must be granted the appropriate Oracle RMU privilege for that command in the database's root file ACL. For some Oracle RMU commands, you must have one or more OpenVMS privileges as well as the appropriate Oracle RMU privilege to be able to use the command.

Note that the root file ACL created by default on each Oracle Rdb database controls only your Oracle RMU access to the database (by specifying privileges that will allow a user or group of users access to specific Oracle RMU commands). Root file ACLs do not control your access to the database with SQL (structured query language) statements. See Section 1.61.7 for information on how to display your Oracle RMU access to the database.

Your access to a database with SQL statements is governed by the privileges granted to you in the database ACL (the ACL that is displayed when you use the SQL SHOW PROTECTION ON DATABASE command).

Table 1–1 shows the Oracle RMU privileges you must have to use each Oracle RMU command. When more than one Oracle RMU privilege appears in the Required Oracle RMU Privileges column, if you have any of the listed Oracle RMU privileges, you will pass the Oracle RMU privilege check for the specified Oracle RMU command.

If the Oracle RMU command requires a user to have one or more OpenVMS privileges in addition to the appropriate Oracle RMU privileges, the OpenVMS privileges are shown in the Required OpenVMS Privileges column of Table 1–1. When more than one OpenVMS privilege is listed in the Required OpenVMS Privileges column, you must have all of the listed OpenVMS privileges to pass the OpenVMS privilege check for the Oracle RMU command.

The OpenVMS Override Privileges column of Table 1–1 shows one or more OpenVMS privileges that allow a user without the appropriate required Oracle RMU and OpenVMS privileges for an Oracle RMU command to use the command anyway. When more than one OpenVMS privilege is listed in the OpenVMS Override Privileges column, you can use the specified Oracle RMU command if you have any of the listed privileges.

Table 1–1 Privileges Required for Oracle RMU Commands

Oracle RMU Command	Required Oracle RMU Privileges	Required OpenVMS Privileges	OpenVMS Override Privileges
Alter	RMU\$ALTER ¹		SYSPRV, BYPASS
Analyze Areas	RMU\$ANALYZE		SYSPRV, BYPASS
Analyze Cardinality	RMU\$ANALYZE		SYSPRV, BYPASS
Analyze Indexes	RMU\$ANALYZE		SYSPRV, BYPASS
Analyze Placement	RMU\$ANALYZE		SYSPRV, BYPASS
Backup	RMU\$BACKUP		SYSPRV, BYPASS
Backup After_Journal	RMU\$BACKUP		SYSPRV, BYPASS
Backup Plan	RMU\$BACKUP		SYSPRV, BYPASS
Checkpoint	RMU\$BACKUP, RMU\$OPEN		WORLD
Close	RMU\$OPEN		WORLD
Collect Optimizer_Statistics	RMU\$ANALYZE		SYSPRV, BYPASS
Convert	RMU\$CONVERT, RMU\$RESTORE		SYSPRV, BYPASS
Copy_Database	RMU\$COPY		SYSPRV, BYPASS
Delete Optimizer_Statistics	RMU\$ANALYZE		SYSPRV, BYPASS
Dump After_Journal	RMU\$DUMP		SYSPRV, BYPASS
Dump Areas	RMU\$DUMP		SYSPRV, BYPASS

¹You must have the OpenVMS SYSPRV or BYPASS privilege if you use an RMU/ALTER command to change a file name.

(continued on next page)

Table 1–1 (Cont.) Privileges Required for Oracle RMU Commands

Oracle RMU Command	Required Oracle RMU Privileges	Required OpenVMS Privileges	OpenVMS Override Privileges
Dump Backup_File	RMU\$DUMP, RMU\$BACKUP, RMU\$RESTORE	READ ²	BYPASS
Dump Export		READ ³	BYPASS
Dump Header	RMU\$DUMP, RMU\$BACKUP, RMU\$OPEN		SYSPRV, BYPASS
Dump Lareas	RMU\$DUMP		SYSPRV, BYPASS
Dump Recovery_Journal		READ ⁴	BYPASS
Dump Row Cache	RMU\$DUMP		SYSPRV, BYPASS
Dump Snapshots	RMU\$DUMP		SYSPRV, BYPASS
Dump Users	RMU\$DUMP, RMU\$BACKUP, RMU\$OPEN		WORLD
Extract	RMU\$UNLOAD		SYSPRV, BYPASS
Insert Optimizer Statistics	RMU\$ANALYZE		SYSPRV, BYPASS
Load	RMU\$LOAD		SYSPRV, BYPASS
Load Audit	RMU\$SECURITY		SECURITY, BYPASS
Load Plan	RMU\$LOAD		SYSPRV, BYPASS

²You must have OpenVMS READ access for the .rbf file.

³You must have OpenVMS READ access for the .rbr or .unl file.

⁴You must have OpenVMS READ access for the .ruj file.

(continued on next page)

Table 1–1 (Cont.) Privileges Required for Oracle RMU Commands

Oracle RMU Command	Required Oracle RMU Privileges	Required OpenVMS Privileges	OpenVMS Override Privileges
Monitor Reopen_Log		WORLD, CMKRNL, DETACH, PSWAPM, ALTPRI, SYSGBL, SYSNAM, SYSPRV, BYPASS	SETPRV
Monitor Start		WORLD, CMKRNL, DETACH, PSWAPM, ALTPRI, PRMMBX, SYSGBL, SYSNAM, SYSPRV, BYPASS	SETPRV
Monitor Stop		WORLD, CMKRNL, DETACH, PSWAPM, ALTPRI, PRMMBX, SYSGBL, SYSNAM, SYSPRV, BYPASS	SETPRV
Move_Area	RMU\$MOVE		SYSPRV, BYPASS
Open	RMU\$OPEN		WORLD
Optimize After_Journal	RMU\$BACKUP, RMU\$RESTORE		SYSPRV, BYPASS
Reclaim	RMU\$ALTER		SYSPRV, BYPASS
Recover	RMU\$RESTORE		SYSPRV, BYPASS

(continued on next page)

Table 1–1 (Cont.) Privileges Required for Oracle RMU Commands

Oracle RMU Command	Required Oracle RMU Privileges	Required OpenVMS Privileges	OpenVMS Override Privileges
Recover Resolve	RMU\$RESTORE		SYSPRV, BYPASS
Repair	RMU\$ALTER		SYSPRV, BYPASS
Resolve	RMU\$RESTORE		SYSPRV, BYPASS
Restore	RMU\$RESTORE		SYSPRV, BYPASS
Restore Only_Root	RMU\$RESTORE		SYSPRV, BYPASS
Server After_Journal Reopen_ Output	RMU\$OPEN		WORLD
Server After_Journal Start	RMU\$OPEN		WORLD
Server After_Journal Stop	RMU\$OPEN		WORLD
Server Backup_Journal Resume	RMU\$OPEN		WORLD
Server Backup_Journal Suspend	RMU\$OPEN		WORLD
Server Record_Cache	RMU\$OPEN		WORLD
Set After_Journal	RMU\$ALTER, RMU\$BACKUP, RMU\$RESTORE		SYSPRV, BYPASS
Set Audit	RMU\$SECURITY		SECURITY, BYPASS
Set Buffer Object	RMU\$ALTER		SYSPRV, BYPASS
Set Corrupt_Pages	RMU\$ALTER, RMU\$BACKUP, RMU\$RESTORE		SYSPRV, BYPASS
Set Galaxy	RMU\$ALTER		SYSPRV, BYPASS
Set Global Buffers	RMU\$ALTER		SYSPRV, BYPASS

(continued on next page)

Table 1–1 (Cont.) Privileges Required for Oracle RMU Commands

Oracle RMU Command	Required Oracle RMU Privileges	Required OpenVMS Privileges	OpenVMS Override Privileges
Set Logminer	RMU\$ALTER, RMU\$BACKUP, RMU\$RESTORE		SYSPRV, BYPASS
Set Privilege	RMU\$SECURITY		SECURITY, BYPASS
Set Row_Cache	RMU\$ALTER		SYSPRV, BYPASS
Set Shared Memory	RMU\$ALTER		SYSPRV, BYPASS
Show After_Journal	RMU\$BACKUP, RMU\$RESTORE, RMU\$VERIFY		SYSPRV, BYPASS
Show Audit	RMU\$SECURITY		SECURITY, BYPASS
Show Corrupt_Pages	RMU\$BACKUP, RMU\$RESTORE, RMU\$VERIFY		SYSPRV, BYPASS
Show Locks		WORLD	
Show Optimizer_Statistics	RMU\$ANALYZE, RMU\$SHOW		SYSPRV, BYPASS
Show Privilege	RMU\$SECURITY		SECURITY, BYPASS
Show Statistics ⁸	RMU\$SHOW		SYSPRV, BYPASS, WORLD
Show System		WORLD	
Show Users ⁵	RMU\$SHOW, RMU\$BACKUP, RMU\$OPEN		WORLD
Show Version			

⁵You must have OpenVMS WORLD access *in addition to* the RMU\$BACKUP, RMU\$OPEN, or RMU\$SHOW privilege for all databases on your node if you do not specify a database file name.

⁸You must have the OpenVMS WORLD privilege if you use this command to display statistics about other users (as opposed to database statistics). You must have both the OpenVMS WORLD and BYPASS privileges if you use this command to update fields in the Database Dashboard.

(continued on next page)

1.4 Required Privileges for Oracle RMU Commands

Table 1–1 (Cont.) Privileges Required for Oracle RMU Commands

Oracle RMU Command	Required Oracle RMU Privileges	Required OpenVMS Privileges	OpenVMS Override Privileges
Unload	RMU\$UNLOAD ⁶		SYSPRV, BYPASS
Unload After_Journal	RMU\$DUMP		SYSPRV, BYPASS
Verify	RMU\$VERIFY ⁷		SYSPRV, BYPASS

⁶The appropriate Oracle Rdb privileges for accessing the database tables involved are also required.

⁷You must also have the SQL DBADM privilege.

1.5 RMU Alter Command

Invokes the RdbALTER utility for Oracle Rdb.

Note

Oracle Corporation recommends that the RdbALTER utility be used only as a last resort to provide a temporary patch to a corrupt database. The RdbALTER utility should not be used as a routine database management tool.

Use the RdbALTER utility only after you fully understand the internal data structure, know the information the database should contain, and know the full effects of the command. Because of the power of the RdbALTER utility and the cascading effects it can have, Oracle Corporation recommends that you experiment on a copy of the damaged database before applying the RdbALTER utility to a production database.

Complete information on the RdbALTER utility is found in Chapter 2, which provides a syntax diagram and description for each RdbALTER command.

To invoke the RdbALTER utility, enter the RMU Alter command in the following format:

```
$ RMU/ALTER [root-file-spec]
```

The optional root file parameter identifies the database you want to alter. If you specify this parameter, you automatically attach to the specified database. If you do not specify this parameter, you must use the RdbALTER ATTACH command. See Section 2.2 for more information on the ATTACH command.

The RMU Alter command responds with the following prompt:

```
RdbALTER>
```

This prompt indicates that the system expects RdbALTER command input.

To access the RdbALTER Help file, enter the following:

```
RdbALTER> HELP
```

1.5 RMU Alter Command

To use the RMU Alter command for a database, you must have the RMU\$ALTER privilege in the root file ACL for the database or the OpenVMS SYSPRV or BYPASS privilege. You must have the OpenVMS SYSPRV or BYPASS privilege if you are using an RMU Alter command to change a file name.

1.6 RMU Analyze Command

Gathers and displays statistics on how the database uses storage, logical area, or page space.

Format

RMU/Analyze root-file-spec

Command Qualifiers

/Areas[=storage-area-list]
/[No]Binary_Output=file-option-list
/End=integer
/Exclude=(options)
/[No]Lareas[=logical-area-list]
/Option = {Normal | Full | Debug}
/Output=file-name
/Start = integer

Defaults

/Areas
/Nobinary_Output
/End=last-page
No logical areas excluded
/Lareas
/Option=Normal
/Output=SYS\$OUTPUT
/Start=first-page

Description

The RMU Analyze command provides a maintenance tool for database administrators. It generates a formatted display of statistical information that describes storage utilization in the database. Information is displayed selectively for storage areas and logical areas, or for a range of pages in a storage area. You can use the RMU Analyze command to analyze the following:

- Space utilization for database pages
- Space utilization for storage areas
- Space utilization for logical areas

Command Parameters

root-file-spec

The file specification for the database root file to be analyzed. The default file extension is .rdb.

1.6 RMU Analyze Command

Command Qualifiers

Areas[=storage-area-list]

Specifies the storage areas to be analyzed. You can specify each storage area by name or by the area's ID number.

The default, the Areas qualifier, results in analysis of all storage areas. You can also specify the Areas=* qualifier to analyze all storage areas. If you specify more than one storage area, separate the storage area names or ID numbers in the storage-area-list parameter with a comma and enclose the list in parentheses. If you omit the Areas qualifier, information for all the storage areas is displayed.

You can use the Start and End qualifiers with the Areas qualifier to analyze specific pages. If you use the Start and End qualifiers when you specify more than one storage area in the storage-area-list parameter, the same specified range of pages are analyzed in each specified storage area.

The Areas qualifier can be used with an indirect command file. See Section 1.3 for more information.

Binary_Output=file-option-list

Nobinary_Output

Allows you to direct the summary results to a binary file, and to create a record definition file that is compatible with the data dictionary for the binary output file. The binary output file can be loaded into an Oracle Rdb database by using the RMU Load command with the Record_Definition qualifier for use by a user-written management application or procedure. The binary output can also be used directly by the user-written application or procedure.

The valid file options are:

- File=file-spec

The File option causes the Analyze command data to be stored in an RMS file that contains a fixed-length binary record for each storage area and logical area analyzed. The default file extension for the binary output file is .unl. The following command creates the binary output file analyze_out.unl:

```
$ RMU/ANALYZE/BINARY_OUTPUT=FILE=ANALYZE_OUT MF_PERSONNEL.RDB
```

1.6 RMU Analyze Command

- **Record_Definition=file-spec**

The **Record_Definition** option causes the Analyze command data record definition to be stored in an RMS file. The output file contains the definition in a subset of the data dictionary command format, a format very similar to RDO field and relation definitions. The default file extension for the record definition output file is **.rrd**. The following command creates the output file **analyze_out.rrd**:

```
$ RMU/ANALYZE/BINARY_OUTPUT=RECORD_DEFINITION=ANALYZE_OUT -  
_ $ MF_PERSONNEL.RDB
```

You can specify both file options in one command by separating them with a comma and enclosing them within parentheses, for example:

```
$ RMU/ANALYZE/BINARY_OUTPUT= -  
_ $ (FILE=ANALYZE_OUT,RECORD_DEFINITION=ANALYZE_OUT) -  
_ $ MF_PERSONNEL.RDB
```

If you specify the **Binary_Output** qualifier, you must specify at least one of the options. The default is the **Nobinary_Output** qualifier, which does not create an output file.

End=integer

Specifies the ending page number for the analysis. The default is the end of the storage area file.

Exclude=options

Excludes information from the RMU Analyze command output. You can specify **Exclude=System_Records** or **Exclude=Metadata**, or both. If you specify both options, enclose them within parentheses and separate each option with a comma.

When you do not specify the **Exclude** qualifier, data is provided for all the logical areas in the database.

The options are as follows:

- **System_Records**

Information on the **RDB\$SYSTEM_RECORDS** logical areas is excluded from the Analyze command output.

- **Metadata**

Information on all the Oracle Rdb logical areas (for example, the **RDB\$SYSTEM_RECORDS** and **RDB\$COLLATIONS_NDX** logical areas) is excluded from the RMU Analyze command output.

1.6 RMU Analyze Command

Data is accumulated for the logical areas excluded with the Exclude qualifier, but the data is excluded from the Analyze output.

You cannot use the Exclude qualifier and the Lareas qualifier in the same RMU Analyze command.

Lareas [=logical-area-list]

Nolareas

Specifies the logical areas to be analyzed. Each table in the database is associated with a logical area name. The default, the Lareas qualifier, results in analysis of all logical areas. You can also specify the Lareas=* qualifier to analyze all logical areas. If you specify more than one logical area name, separate the logical area names in the logical-area-list with a comma and enclose the list in parentheses.

The Lareas qualifier can be used with indirect command files. See Section 1.3 for more information.

Option=type

Specifies the type of information and level of detail the analysis will include. Three types of output are available:

- Normal
Output includes only summary information. The Normal option is the default.
- Full
Output includes histograms and summary information.
- Debug
Output includes internal information about the data, as well as histograms and summary information. In general, use the Debug option for diagnostic support purposes. You can also use the Debug option to extract data and perform an independent analysis.

Output=file-name

Specifies the name of the file where output will be sent. The default file extension is .lis. If you do not specify the Output qualifier, the output is sent to SYS\$OUTPUT.

Start=integer

Specifies the starting page number for the analysis. The default is 1.

1.6 RMU Analyze Command

Usage Notes

- To use the RMU Analyze command for a database, you must have the RMU\$ANALYZE privilege in the root file ACL for the database or the OpenVMS SYSPRV or BYPASS privilege.
- When the RMU Analyze command is issued for a closed database, the command executes without other users being able to attach to the database.
- The RMU Analyze command supports the analysis of write-once storage areas on write-once, read-many (WORM) optical disk devices. All uninitialized pages, including those past the last updated page, will be analyzed as if they were initialized. Because all allocated pages are counted as free pages, you might have more pages analyzed than you expect.
- Detected asynchronous prefetch should be enabled to achieve the best performance of this command. Beginning with Oracle Rdb V7.0, by default, detected asynchronous prefetch is enabled. You can determine the setting for your database by issuing the RMU Dump command with the Header qualifier.

If detected asynchronous prefetch is disabled, and you do not want to enable it for the database, you can enable it for your Oracle RMU operations by defining the following logicals at the process level:

```
$ DEFINE RDM$BIND_DAPF_ENABLED 1
$ DEFINE RDM$BIND_DAPF_DEPTH_BUF_CNT P1
```

P1 is a value between 10 and 20 percent of the user buffer count.

- The following RMU Analyze command directs the results into a record definition file called db.rrd. This file is compatible with the syntax for creating new columns and tables in the data dictionary.

```
$ RMU/ANALYZE/BINARY_OUTPUT=RECORD_DEFINITION=DB.RRD MF_PERSONNEL
$! Display the db.rrd file created by the previous command:
$ TYPE DB.RRD
```

```
DEFINE FIELD RMU$DATE DATATYPE IS DATE.
DEFINE FIELD RMU$AREA_NAME DATATYPE IS TEXT SIZE IS 32.
DEFINE FIELD RMU$STORAGE_AREA_ID DATATYPE IS SIGNED WORD.
DEFINE FIELD RMU$FLAGS DATATYPE IS SIGNED WORD.
DEFINE FIELD RMU$TOTAL_BYTES DATATYPE IS F_FLOATING.
DEFINE FIELD RMU$EXPANDED_BYTES DATATYPE IS F_FLOATING.
DEFINE FIELD RMU$FRAGMENTED_BYTES DATATYPE IS F_FLOATING.
DEFINE FIELD RMU$EXPANDED_FRAGMENT_BYTES DATATYPE IS F_FLOATING.
DEFINE FIELD RMU$TOTAL_COUNT DATATYPE IS F_FLOATING.
DEFINE FIELD RMU$FRAGMENTED_COUNT DATATYPE IS F_FLOATING.
```

1.6 RMU Analyze Command

```
DEFINE FIELD RMU$FRAGMENT_COUNT DATATYPE IS F_FLOATING.  
DEFINE FIELD RMU$PAGE_LENGTH DATATYPE IS SIGNED WORD.  
DEFINE FIELD RMU$MAX_PAGE_NUMBER DATATYPE IS SIGNED LONGWORD.  
DEFINE FIELD RMU$FREE_BYTES DATATYPE IS F_FLOATING.  
DEFINE FIELD RMU$OVERHEAD_BYTES DATATYPE IS F_FLOATING.  
DEFINE FIELD RMU$AIP_COUNT DATATYPE IS F_FLOATING.  
DEFINE FIELD RMU$ABM_COUNT DATATYPE IS F_FLOATING.  
DEFINE FIELD RMU$SPAM_COUNT DATATYPE IS F_FLOATING.  
DEFINE FIELD RMU$INDEX_COUNT DATATYPE IS F_FLOATING.  
DEFINE FIELD RMU$BTREE_NODE_BYTES DATATYPE IS F_FLOATING.  
DEFINE FIELD RMU$HASH_BYTES DATATYPE IS F_FLOATING.  
DEFINE FIELD RMU$DUPLICATES_BYTES DATATYPE IS F_FLOATING.  
DEFINE FIELD RMU$OVERFLOW_BYTES DATATYPE IS F_FLOATING.  
DEFINE FIELD RMU$LOGICAL_AREA_ID DATATYPE IS SIGNED WORD.  
DEFINE FIELD RMU$RELATION_ID DATATYPE IS SIGNED WORD.  
DEFINE FIELD RMU$RECORD_ALLOCATION_SIZE DATATYPE IS SIGNED WORD.  
DEFINE FIELD RMU$TOTAL_SPACE DATATYPE IS F_FLOATING.  
DEFINE RECORD RMU$ANALYZE_AREA.  
.  
.  
.
```

- The following list describes each of the fields in the db.rrd record definition:
 - **RMU\$DATE**
Contains the date that the Analyze operation was done
 - **RMU\$AREA_NAME**
Contains the name of the storage area that was analyzed
 - **RMU\$STORAGE_AREA_ID**
Contains the area ID of the storage area that was analyzed
 - **RMU\$FLAGS**
The three possible values in this field have the following meanings:
 - * 0—Indicates that the record is a storage area record, not a logical area record
 - * 1—Indicates that data compression is not enabled for the logical area
 - * 3—Indicates that data compression is enabled for the logical area

1.6 RMU Analyze Command

- **RMU\$TOTAL_BYTES**
Contains the total size of the data stored in the logical area
- **RMU\$EXPANDED_BYTES**
Contains the total size of the stored data in the logical area after decompression
- **RMU\$FRAGMENTED_BYTES**
Contains the number of bytes in the stored fragments
- **RMU\$EXPANDED_FRAGMENT_BYTES**
Contains the number of bytes in the stored fragments after decompression
- **RMU\$TOTAL_COUNT**
Contains the total number of records stored
- **RMU\$FRAGMENTED_COUNT**
Contains the number of fragmented records
- **RMU\$FRAGMENT_COUNT**
Contains the number of stored fragments
- **RMU\$PAGE_LENGTH**
Contains the length in bytes of a database page in the storage area
- **RMU\$MAX_PAGE_NUMBER**
Contains the page number of the last initialized page in the storage area
- **RMU\$FREE_BYTES**
Contains the number of free bytes in the storage area
- **RMU\$OVERHEAD_BYTES**
Contains the number of bytes used for overhead in the storage area
- **RMU\$AIP_COUNT**
Contains the number of the area inventory pages (AIPs) in the storage area
- **RMU\$ABM_COUNT**
Contains the number of area bit map (ABM) pages in the storage area

1.6 RMU Analyze Command

- RMU\$SPAM_COUNT
Contains the number of space area management (SPAM) pages in the storage area
- RMU\$INDEX_COUNT
Contains the number of index records in the storage area
- RMU\$BTREE_NODE_BYTES
Contains the number of bytes for sorted indexes in the storage area
- RMU\$HASH_BYTES
Contains the number of bytes for hashed indexes in the storage area
- RMU\$DUPLICATES_BYTES
Contains the number of bytes for duplicate key values for sorted indexes in the storage area
- RMU\$OVERFLOW_BYTES
Contains the number of bytes for hash bucket overflow records in the storage area
- RMU\$LOGICAL_AREA_ID
Contains the logical area ID of the logical area that was analyzed
- RMU\$RELATION_ID
Contains the record type of the row in the logical area that was analyzed
- RMU\$RECORD_ALLOCATION_SIZE
Contains the size of a row when the table was initially defined
- RMU\$TOTAL_SPACE
Contains the number of bytes available for storing user data in the logical area (used space + free space + overhead)

Examples

Example 1

The following command analyzes the EMPIDS_LOW and EMP_INFO storage areas in the mf_personnel database:

```
$ RMU/ANALYZE/AREAS=(EMPIDS_LOW,EMP_INFO)/OUTPUT=EMP.OUT -  
_ $ MF_PERSONNEL.RDB
```

1.6 RMU Analyze Command

Example 2

Both of the following commands analyze the DEPARTMENTS and SALARY_HISTORY storage areas in the mf_personnel database:

```
$! Using storage area names to specify storage areas
$ RMU/ANALYZE/AREAS=(DEPARTMENTS,SALARY_HISTORY) MF_PERSONNEL.RDB -
$ /OUTPUT=DEP_SAL.OUT
$!
$! Using storage area ID numbers to specify storage areas
$ RMU/ANALYZE/AREAS=(2,9) MF_PERSONNEL.RDB /OUTPUT=DEP_SAL.OUT
```

1.7 RMU Analyze Cardinality Command

1.7 RMU Analyze Cardinality Command

Generates a formatted display of the actual and stored cardinality values for specified tables and indexes. Also, if the stored cardinality values are different from the actual cardinality values, the RMU Analyze Cardinality command allows you to update the stored cardinality values.

Note

Beginning in Oracle Rdb Version 7.0, the RMU Analyze Cardinality command has been deprecated and might be removed in future versions of Oracle Rdb. The features available through this command are now available through the RMU Collect Optimizer_Statistics command and the RMU Show Optimizer_Statistics command.

In addition, updating cardinality information for indexes using the RMU Analyze Cardinality command may cause poor performance because the prefix cardinality information is not collected.

Therefore, Oracle Corporation recommends that you use the RMU Collect Optimizer_Statistics and RMU Show Optimizer_Statistics commands instead of the RMU Analyze Cardinality command.

See Section 1.15 and Section 1.61.6 for information on the RMU Collect Optimizer_Statistics and the RMU Show Optimizer_Statistics commands.

Format

RMU Analyze/Cardinality root-file-spec [table-or-index-name[,...]]

Command Qualifiers

/[No]Confirm
/Output = file-name
/Transaction_Type=option
/[No]Update

Defaults

/Noconfirm
/Output = SYS\$OUTPUT
/Transaction_Type=Automatic
/Noupdate

1.7 RMU Analyze Cardinality Command

Description

The actual cardinality values for tables and indexes can be different from the stored cardinality values in your database's RDB\$SYSTEM storage area if RDB\$SYSTEM has been set to read-only access. When rows are added to or deleted from tables and indexes after the RDB\$SYSTEM storage area has been set to read-only access, the cardinality values for these tables and indexes are not updated.

For indexes, the cardinality value is the number of unique entries for an index that allows duplicates. If the index is unique, Oracle Rdb stores zero for the cardinality, and uses the table cardinality instead. For tables, the cardinality value is the number of rows in the table. Oracle Rdb uses the cardinality values of indexes and tables to influence decisions made by the optimizer. If the actual cardinality values of tables and indexes are different from the stored cardinality values, the optimizer's performance can be adversely affected.

When you use the SQL ALTER DATABASE statement to set the RDB\$SYSTEM storage area to read-only access for your database, the Oracle Rdb system tables in the RDB\$SYSTEM storage area are also set to read-only access. When the Oracle Rdb system tables are set to read-only access:

- Automatic updates to table and index cardinality are disabled.
- Manual changes made to the cardinalities to influence the optimizer are not allowed.
- The I/O associated with the cardinality update is eliminated.

With the RMU Analyze Cardinality command, you can:

- Display the stored and actual cardinality values for the specified tables and indexes.
- Update the stored cardinality value for a specified table or index with either the actual value or an alternative value of your own choosing. Oracle Corporation recommends that you update the stored cardinality value with the actual cardinality value. Specifying a value other than the actual cardinality value can result in poor database performance.

1.7 RMU Analyze Cardinality Command

Command Parameters

root-file-spec

The name of the database root file for which you want information. The default file extension is .rdb. This parameter is required.

table-or-index-name[,...]

The name of the table or index for which you want information about cardinality. The default is all tables and all enabled indexes. If you want information about a disabled index, you must specify it by name.

If you do not accept the default and instead specify a table name, the RMU Analyze Cardinality command and any qualifiers you specify will affect only the named table; the command will not result in a display or update (if the Update qualifier is specified) of the indexes associated with the table.

This parameter is optional. An indirect file reference can be used. See Section 1.3 for more information.

Command Qualifiers

Confirm

Noconfirm

Specify the Confirm qualifier with the Update qualifier to gain more control over the update function. When you specify the Confirm qualifier, you are asked whether the update should be performed for each selected table or index whose stored cardinality value is different from its actual cardinality value. You can respond with YES, NO, QUIT, or an alternative value for the stored cardinality.

Specifying YES means that you want to update the stored cardinality with the actual cardinality value. Specifying NO means that you do not want to update the stored cardinality value. Specifying QUIT aborts the RMU Analyze Cardinality command, rolls back any changes you made to stored cardinalities, and returns you to the operating system prompt. Specifying an alternative value updates the stored cardinality value with the alternative value.

When you specify the Noconfirm qualifier, you are not given the option of updating stored cardinality values with an alternative value of your own choosing. Instead, the stored cardinality values that differ from the actual cardinality values are automatically updated with the actual cardinality values.

The default is the Noconfirm qualifier.

1.7 RMU Analyze Cardinality Command

The Confirm and Noconfirm qualifiers are meaningless and are ignored if they are specified without the Update qualifier.

Output=file-name

Specifies the name of the file where output will be sent. The default is SYS\$OUTPUT. The default output file type is .lis, if you specify a file name.

Transaction_Type=option

Allows you to specify the transaction mode for the transactions used to perform the analyze operation. Valid options are:

- Automatic
- Read_Only
- Noread_Only

You must specify an option if you use this qualifier.

If you do not specify any form of this qualifier, the Transaction_Type=Automatic qualifier is the default. This qualifier specifies that Oracle RMU is to determine the transaction mode used for the analyze operation. If any storage area in the database (including those not accessed for the analyze operation) has snapshots disabled, the transactions used for the analyze operation are set to read/write mode. Otherwise, the transactions are set to read-only mode.

The Transaction_Type=Read_Only qualifier specifies the transactions used to perform the analyze operation be set to read-only mode. When you explicitly set the transaction type to read-only, snapshots need not be enabled for all storage areas in the database, but must be enabled for those storage areas that are analyzed. Otherwise, you receive an error and the analyze operation fails.

You might select this option if not all storage areas have snapshots enabled and you are analyzing objects that are stored only in storage areas with snapshots enabled. In this case, using the Transaction_Type=Read_Only qualifier allows you to perform the analyze operation and impose minimal locking on other users of the database.

The Transaction_Type=Noread_Only qualifier specifies that the transactions used to for the analyze operation be set to read/write mode. You might select this option if you want to eradicate the growth of snapshot files that occurs during a read-only transaction and are willing to incur the cost of increased locking that occurs during a read/write transaction.

1.7 RMU Analyze Cardinality Command

Update

Noupdate

Specify the Update qualifier to update the stored cardinality values of tables and indexes. You can perform an update only when the stored cardinality values differ from the actual cardinality values. When updating cardinality values, Oracle Corporation recommends that you update the stored cardinality values with the actual cardinality values, not with an alternative value of your own choosing. Specifying a value other than the actual cardinality value can result in poor database performance. The default is the Noupdate qualifier.

Using the Update qualifier allows you to update the stored cardinality values of the specified tables and indexes even when the RDB\$SYSTEM storage area is designated for read-only access. If you have set the RDB\$SYSTEM storage area to read-only access, Oracle RMU sets it to read/write during execution of the RMU Analyze Cardinality command with the Update qualifier. Oracle RMU resets the area to read-only when the operation completes.

If you are updating the stored cardinality for a table or index, and a system failure occurs before the RDB\$SYSTEM storage area is changed back to read-only access, use the SQL ALTER DATABASE statement to manually change the database back to read-only access.

However, note that if you have set the area to read-only, the update operation specified with the Update qualifier commences only if the database is off line or the database is quiescent.

If you specify a table name parameter with an RMU Analyze Cardinality command that includes the Update qualifier, the associated indexes are not updated; you must specify each table and index you want to be updated or accept the default (by not specifying any table or index names) and have all items updated.

Oracle Corporation recommends that you use the Update qualifier during offline operations or during a period of low update activity. If you update a cardinality while it is changing (as a result of current database activity), the end result is unpredictable.

Specify the Noupdate qualifier when you want to display the stored and actual cardinality values only for the specified tables and indexes.

1.7 RMU Analyze Cardinality Command

Usage Notes

- To use the RMU Analyze Cardinality command for a database, you must have the RMU\$ANALYZE privilege in the root file ACL for the database or the OpenVMS SYSPRV or BYPASS privilege.
- You must have the SQL ALTER privilege for the database to update a read-only RDB\$SYSTEM storage area.
- If you specify a name for the table-or-index-name parameter that is both an index name and a table name, the RMU Analyze Cardinality command performs the requested operation for both the table and index.
- Although you can alter the cardinality of a unique index using the RMU Analyze Cardinality command, it has no effect. (A unique index has only unique keys and does not have any duplicate keys.) Because the cardinality of a unique index and the table it indexes are the same, Oracle Rdb uses the table cardinality value when performing operations that involve the cardinality of a unique index. Oracle Rdb does not use the cardinality value stored for a unique index, nor does it attempt to update this value as rows are stored or deleted.
- When the RMU Analyze Cardinality command is issued for a closed database, the command executes without other users being able to attach to the database.

Examples

Example 1

The following command provides information on the cardinality for all indexes and tables in the sample mf_personnel database:

```
$ RMU/ANALYZE/CARDINALITY/NOUPDATE MF_PERSONNEL.RDB /OUTPUT=CARD.LIS
```

Example 2

The following command provides information on the cardinality for the EMPLOYEES table in the mf_personnel database:

```
$ RMU/ANALYZE/CARDINALITY/NOUPDATE MF_PERSONNEL.RDB EMPLOYEES -  
_$_ /OUTPUT=EMP.LIS
```

1.8 RMU Analyze Indexes Command

1.8 RMU Analyze Indexes Command

Generates a formatted display of statistical information that describes the index structures for the database.

Format

```
RMU/Analyze/Indexes root-file-spec [index-name[,...]]
```

Command Qualifiers

```
/[No]Binary_Output[=file-option-list]  
/Exclude = Metadata  
/Option = {Normal | Full | Debug}  
/Output = file-name  
/Transaction_Type=option
```

Defaults

```
/Nobinary_Output  
All index data displayed  
/Option=Normal  
/Output=SYS$OUTPUT  
/Transaction_Type=Automatic
```

Description

The RMU Analyze Indexes command provides a maintenance tool for analyzing index structures and generates a formatted display of this statistical information. Information is displayed selectively for storage areas and logical areas, or for a range of pages in a storage area. You can use the RMU Analyze Indexes command to analyze the structures of both sorted (including ranked sorted) and hashed indexes. The following shows sample output from the RMU Analyze Index command:

```
$ RMU/ANALYZE/INDEXES MF_PERSONNEL.RDB JH_EMPLOYEE_ID_RANKED
```

```
-----  
Indices for database - RDBVMS_DISK1:[DB]MF_PERSONNEL.RDB;  
-----
```

```
Index JH_EMPLOYEE_ID_RANKED for relation JOB_HISTORY duplicates allowed  
Max Level: 3, Nodes: 34, Used/Avail: 8693/13532 (64%), Keys: 133, Records: 0  
Duplicate nodes:0, Used/Avail: 0/0 (0%), Keys: 100, Maps: 100, Records:4113  
Total Comp/Uncomp IKEY Size: 600/798, Compression Ratio: .75  
-----
```

Data included in the statistics display includes the following information:

- The first line of output identifies the database in which the analyzed index resides.

1.8 RMU Analyze Indexes Command

- The second line of output:
 - Specifies if the index is a hashed index. In the example, the index is not hashed, so the term hashed does not appear.
 - The index name
 - Whether or not duplicates are allowed.
- Third line of output:
 - Max Level
The maximum number of levels in the index.
 - Nodes
The total number of nodes in the index.
 - Used/Avail (%)
The number of bytes used by the index/the number of bytes available. (The percentage of space used by the index.)
 - Keys
The sum of the dbkeys that point directly to data records plus those that point to duplicate nodes.
 - Records
The number of data records to which the Keys (in the previous list item) point directly.
- The fourth line of output:
 - Duplicate nodes
For hashed and nonranked sorted indexes, this is the number of duplicate nodes in the index. For a ranked sorted index, this is the number of overflow nodes. With ranked sorted indexes, Oracle Rdb compresses duplicates using a byte-aligned bitmap compression. It compresses the list of dbkeys that point to duplicates and stores that list in the index key node. Oracle Rdb creates overflow nodes when the compressed list of duplicates does not fit in one index key node. This overflow node contains a bitmap compressed list of dbkeys and pointers to the next overflow node. Therefore, for ranked sorted indexes, the duplicate nodes count (overflow nodes) can be zero (0) if the compressed list of dbkeys that point to duplicates fits into one node.
 - Used/Avail (%)

1.8 RMU Analyze Indexes Command

The number of bytes used by duplicate nodes/number of bytes available in the duplicate nodes. (The percentage of space used within the duplicate nodes of the index.) This value can be zero (0) for a ranked sorted index if the number of duplicate nodes is zero.

- Keys
The total number of dbkeys that point to a duplicate node or that point to the beginning of a duplicate node chain in the index.
- Maps (appears only if the index is a ranked sorted index)
The number of duplicate key data record bit maps used by ranked sorted indexes to represent the duplicate index key data record dbkeys.
- Records
The total number of data records pointed to by duplicate nodes. If the index is a ranked sorted index, Records refers to the number of data records pointed to by duplicate bit maps.
- The fifth line of output (appears only if the index is compressed):
 - Total Comp/Uncomp IKEY Size
The total byte count of the compressed leaf index keys (level 1 nodes only)/the total byte count that would be consumed if the index were not compressed
 - Compression ratio.
The calculated ratio of Total Comp/Uncomp. A compression ratio greater than 1.0 indicates that the compressed index keys occupy more space than the uncompressed index keys.

For more information on RMU Analyze Indexes and the display of index keys, refer to the *Oracle Rdb7 Guide to Database Performance and Tuning*.

Command Parameters

root-file-spec

The file specification for the database root file for which you want information. The default file extension is .rdb. This parameter is required.

index-name[,...]

The name of the index for which you want information. The default is all enabled indexes. If you want information about a disabled index, you must specify it by name. This parameter is optional. An indirect file reference can be used. See Section 1.3 for more information.

1.8 RMU Analyze Indexes Command

Command Qualifiers

Binary_Output[=file-option-list]

Nobinary_Output

Specifying the Binary_Output qualifier allows you to store the summary results in a binary file, and to create a record definition file that is compatible with the data dictionary for the binary output file. The binary output can be loaded into an Oracle Rdb database by using the RMU Load command with the Record_Definition qualifier for use by a user-written management application or procedure. The binary output can also be used directly by the user-written application or procedure.

The valid file options are:

- **File=file-spec**

The File option causes the RMU Analyze Indexes command data to be stored in an RMS file that contains a fixed-length binary record for each index analyzed.

The default file extension for the binary output file is .unl. The following command creates the binary output file analyze_out.unl:

```
$ RMU/ANALYZE/INDEXES -  
_$_ /BINARY_OUTPUT=FILE=ANALYZE_OUT MF_PERSONNEL.RDB
```

- **Record_Definition=file-spec**

The Record_Definition option causes the RMU Analyze Indexes command data record definition to be stored in an RMS file. The output file contains the record definition in a subset of the data dictionary command format. The default file extension for the record definition output file is .rrd. Refer to Appendix A for a description of the .rrd files. The following command creates the output file analyze_out.rrd:

```
$ RMU/ANALYZE/INDEXES -  
_$_ /BINARY_OUTPUT=RECORD_DEFINITION=ANALYZE_OUT MF_PERSONNEL.RDB
```

You can specify both file options in one command by separating them with a comma and enclosing them within parentheses, as follows:

```
$ RMU/ANALYZE/INDEXES/BINARY_OUTPUT= -  
_$_ (FILE=ANALYZE_OUT,RECORD_DEFINITION=ANALYZE_OUT) -  
_$_ MF_PERSONNEL.RDB
```

If you specify the Binary_Output qualifier, you must specify at least one of the options. The default is the Nobinary_Output qualifier, which does not create an output file.

1.8 RMU Analyze Indexes Command

Exclude=Metadata

Excludes information from the RMU Analyze Indexes command output. When you specify the Exclude=Metadata qualifier, information on the Oracle Rdb indexes (for example, the RDB\$NDX_REL_NAME_NDX and RDB\$COLLATIONS_NDX indexes) is excluded from the RMU Analyze Indexes command output. When you do not specify the Exclude qualifier, data is provided for all indexes in the database.

Data is accumulated for the indexes excluded with the Exclude qualifier, but the data is excluded from the RMU Analyze Indexes command output.

You cannot specify the Exclude qualifier and one or more index names in the same RMU Analyze Indexes command.

Option=type

Specifies the type of information and the level of detail the analysis will include. Three types of output are available:

- Normal
Output includes only summary information. The Normal option is the default.
- Full
Output includes histograms and summary information. This option displays a summary line for each sorted index level.
- Debug
Output includes internal information about the data, histograms, and summary information. Note the following when using this option to analyze compressed index keys:
 - The key lengths are from the compressed index keys.
 - The hexadecimal output for the keys is that of the uncompressed index keys.
 - The output includes summary statistics about the compressed index keys.

In general, use the Debug option for diagnostic support purposes. You can also use the Debug option to extract data and perform an independent analysis.

Output=file-name

Specifies the name of the file where output will be sent. The default is SYS\$OUTPUT. The default output file extension is .lis, if you specify a file name.

1.8 RMU Analyze Indexes Command

Transaction_Type=option

Allows you to specify the transaction mode for the transactions used to perform the analyze operation. Valid options are:

- Automatic
- Read_Only
- Noread_Only

You must specify an option if you use this qualifier.

If you do not use any form of this qualifier, the `Transaction_Type=Automatic` qualifier is the default. This qualifier specifies that Oracle RMU is to determine the transaction mode used for the analyze operation. If any storage area in the database (including those not accessed for the analyze operation) has snapshots disabled, the transactions used for the analyze operation are set to read/write mode. Otherwise, the transactions are set to read-only mode.

The `Transaction_Type=Read_Only` qualifier specifies the transactions used to perform the analyze operation be set to read-only mode. When you explicitly set the transaction type to read-only, snapshots need not be enabled for all storage areas in the database, but must be enabled for those storage areas that are analyzed. Otherwise, you receive an error and the analyze operation fails.

You might select this option if not all storage areas have snapshots enabled and you are analyzing objects that are stored only in storage areas with snapshots enabled. In this case, using the `Transaction_Type=Read_Only` qualifier allows you to perform the analyze operation and impose minimal locking on other users of the database.

The `Transaction_Type=Noread_Only` qualifier specifies that the transactions used to for the analyze operation be set to read/write mode. You might select this option if you want to eradicate the growth of snapshot files that occurs during a read-only transaction and are willing to incur the cost of increased locking that occurs during a read/write transaction.

Usage Notes

- To use the RMU Analyze Indexes command for a database, you must have the `RMU$ANALYZE` privilege in the root file access control list (ACL) for the database or the OpenVMS `SYSPRV` or `BYPASS` privilege.
- When the RMU Analyze Indexes command is issued for a closed database, the command executes without other users being able to attach to the database.

1.8 RMU Analyze Indexes Command

- The RMU Analyze Indexes command supports the analysis of index structures in write-once storage areas on write-once, read-many (WORM) optical disk devices. All uninitialized pages, including those past the logical end-of-file, are analyzed as if they were initialized. Because all allocated pages are counted as free pages, you might have more pages analyzed than you expect.
- The following RMU Analyze Indexes command produces an RMS record definition file called `index.rrd` that can be read by the RMU Load command and the data dictionary:

```
$ RMU/ANALYZE/INDEX/BINARY_OUTPUT=RECORD_DEFINITION=INDEX.RRD -
_ $ MF_PERSONNEL
$!
$! Display the index.rrd file created by the previous command:
$ TYPE INDEX.RRD
```

```
DEFINE FIELD RMU$DATE DATATYPE IS DATE.
DEFINE FIELD RMU$INDEX_NAME DATATYPE IS TEXT SIZE IS 32.
DEFINE FIELD RMU$RELATION_NAME DATATYPE IS TEXT SIZE IS 32.
DEFINE FIELD RMU$LEVEL DATATYPE IS SIGNED WORD.
DEFINE FIELD RMU$FLAGS DATATYPE IS SIGNED WORD.
DEFINE FIELD RMU$COUNT DATATYPE IS F_FLOATING.
DEFINE FIELD RMU$USED DATATYPE IS F_FLOATING.
DEFINE FIELD RMU$AVAILABLE DATATYPE IS F_FLOATING.
DEFINE FIELD RMU$DUPLICATE_COUNT DATATYPE IS F_FLOATING.
DEFINE FIELD RMU$DUPLICATE_USED DATATYPE IS F_FLOATING.
DEFINE FIELD RMU$DUPLICATE_AVAILABLE DATATYPE IS F_FLOATING.
DEFINE FIELD RMU$KEY_COUNT DATATYPE IS F_FLOATING.
DEFINE FIELD RMU$DATA_COUNT DATATYPE IS F_FLOATING.
DEFINE FIELD RMU$DUPLICATE_KEY_COUNT DATATYPE IS F_FLOATING.
DEFINE FIELD RMU$DUPLICATE_DATA_COUNT DATATYPE IS F_FLOATING.
DEFINE FIELD RMU$TOTAL_COMP_IKEY_COUNT DATATYPE IS F_FLOATING.
DEFINE FIELD RMU$TOTAL_IKEY_COUNT DATATYPE IS F_FLOATING.
DEFINE RECORD RMU$ANALYZE_INDEX.
```

- The following list describes each of the fields in the `index.rrd` record definition:
 - **RMU\$DATE**
Contains the date that the analyze operation was done
 - **RMU\$INDEX_NAME**
Contains the name of the index that was analyzed
 - **RMU\$RELATION_NAME**
Contains the name of the table for which the index is defined

1.8 RMU Analyze Indexes Command

- **RMU\$LEVEL**
Contains the maximum number of index levels
 - **RMU\$FLAGS**
The eight possible values in this field have the following meanings:
 - * 0—Index is sorted and not unique. A full report is not generated.
 - * 1—Index is sorted and unique. A full report is not generated.
 - * 2—Index is hashed and not unique. A full report is not generated.
 - * 3—Index is hashed and unique. A full report is not generated.
 - * 4—Index is sorted and not unique. A full report is generated.
 - * 5— Index is sorted and unique. A full report is generated.
 - * 6— Index is hashed and not unique. A full report is generated.
 - * 7—Index is hashed and unique. A full report is generated.
 - * 8—Index is sorted ranked and not unique. A full report is not generated.
 - * 9—Index is sorted ranked and unique. A full report is not generated.
 - * 12—Index is sorted ranked and not unique. A full report is generated.
 - * 13—Index is sorted ranked and unique. A full report is generated.
- The RMU Analyze Indexes command uses the RMU\$FLAGS bits shown in Table 1–2 for describing specific index information.

Table 1–2 RMU\$FLAGS Bits Used by the RMU Analyze Indexes Command

Bit Offset	Meaning
0	Unique index if true
1	Hashed index if true
2	Full report record if true
3	Ranked index if true

When RMU\$FLAGS has bit 2 set it means that a full report is generated. A full report has records for each level of the index.

1.8 RMU Analyze Indexes Command

- RMU\$COUNT
Contains the number of index nodes
- RMU\$USED
Contains the amount of available space that is used
- RMU\$AVAILABLE
Contains the amount of space available in the index records initially
- RMU\$DUPLICATE_COUNT
Contains the number of duplicate records
- RMU\$DUPLICATE_USED
Contains the amount of available space used in the duplicate records
- RMU\$DUPLICATE_AVAILABLE
Contains the amount of space available in the duplicate records initially
- RMU\$KEY_COUNT
Contains the number of keys
- RMU\$DATA_COUNT
Contains the number of records
- RMU\$DUPLICATE_KEY_COUNT
Contains the number of duplicate keys
- RMU\$DUPLICATE_DATA_COUNT
Contains the number of duplicate records
- RMU\$TOTAL_COMP_IKEY_COUNT
Contains the number of compressed index key bytes
- RMU\$TOTAL_IKEY_COUNT
Contains the number of bytes that would be used by index keys, had they not been compressed

1.8 RMU Analyze Indexes Command

Examples

Example 1

The following command analyzes the JH_EMPLOYEE_ID and SH_EMPLOYEE_ID indexes in the mf_personnel database:

```
$ RMU/ANALYZE/INDEXES MF_PERSONNEL.RDB JH_EMPLOYEE_ID,SH_EMPLOYEE_ID -
_$/OUTPUT=EMP_ID_INDEX.LIS
```

Example 2

The following commands demonstrate the differences you see when you analyze a nonranked sorted index and a ranked sorted index. Note the differences in the values for the Duplicate nodes. The nonranked sorted index displays 80 duplicate nodes. The ranked sorted index (before more duplicates are added) displays 0 duplicate nodes for the same data. After hundreds of more duplicates are added, the ranked sorted index shows only 3 duplicate nodes. The differences you see are because of the different way duplicate records are stored for nonranked sorted indexes and ranked sorted indexes. See the Description section under this command for details on these differences.

```
$ ! Analyze a nonranked sorted index:
$ !
$ RMU/ANALYZE/INDEXES MF_PERSONNEL.RDB JH_EMPLOYEE_ID
-----

Indices for database - USER1:[DB]MF_PERSONNEL.RDB;1

-----

Index JH_EMPLOYEE_ID for relation JOB_HISTORY duplicates allowed
Max Level: 2, Nodes: 4, Used/Avail: 768/1592 (48%), Keys: 103, Records: 20
Duplicate nodes: 80, Used/Avail: 2032/4696 (43%), Keys: 80, Records: 254
-----

$ ! Analyze a ranked sorted index defined on the same column as the
$ ! nonranked sorted index:

$ RMU/ANALYZE/INDEXES MF_PERSONNEL.RDB JH_EMPLOYEE_ID_RANKED
-----

Indices for database - USER1:[DB]MF_PERSONNEL.RDB;1
```

1.8 RMU Analyze Indexes Command

```
-----  
Index JH_EMPLOYEE_ID_RANKED for relation JOB_HISTORY duplicates allowed  
Max Level: 2, Nodes: 11, Used/Avail: 2318/4378 (53%), Keys: 110, Records: 20  
Duplicate nodes: 0, Used/Avail: 0/0 (0%), Keys: 80, Maps: 80, Records: 254  
-----
```

```
$ !  
$ ! Insert many duplicates and analyze the ranked sorted index again:  
$ !  
$ RMU/ANALYZE/INDEXES MF_PERSONNEL.RDB JH_EMPLOYEE_ID_RANKED  
-----
```

```
Indices for database - USER1:[DB]MF_PERSONNEL.RDB;1
```

```
-----  
Index JH_EMPLOYEE_ID_RANKED for relation JOB_HISTORY duplicates allowed  
Max Level: 2, Nodes: 13, Used/Avail: 2705/5174 (52%), Keys: 112, Records: 20  
Duplicate nodes:3, Used/Avail:850/1194 (71%), Keys:80, Maps: 83, Records:2964  
-----
```

1.9 RMU Analyze Placement Command

1.9 RMU Analyze Placement Command

Generates a formatted display of statistical information describing the row placement relative to the index structures for the database.

Format

```
RMU/Analyze/Placement root-file-spec [index-name[,...]]
```

Command Qualifiers

```
/Areas[=storage-area-list]
/[No]Binary_Output[=file-option-list]
/Exclude = Metadata
/Option = {Normal | Full | Debug}
/Output=file-name
/Transaction_Type=option
```

Defaults

```
/Areas
/NoBinary_Output
All index data displayed
/Option = Normal
/Output = SYS$OUTPUT
/Transaction_Type=Automatic
```

Description

The RMU Analyze Placement command provides a maintenance tool for analyzing row placement relative to index structures and generates a formatted display of this statistical information. Information is displayed selectively for any specified storage area.

The RMU Analyze Placement command supports the analysis of row placement relative to index structures in write-once storage areas on write-once, read-many (WORM) optical disk devices. All uninitialized pages, including those past the logical end-of-file, will be analyzed as if they were initialized. This means that all allocated pages are counted as free pages. You might have more pages analyzed than you expect.

You can use the RMU Analyze Placement command to determine:

- The maximum and average path length to a data record. (The maximum and average number of records touched to reach a data record.)
- The estimated maximum I/O path length to a data record.
- The estimated minimum I/O path length to a data record.
- The frequency distributions for the database key (dbkey) path lengths, maximum I/O path lengths, and minimum I/O path lengths for specified indexes.

1.9 RMU Analyze Placement Command

- The distribution of data records on data pages in a storage area by logical area identifier (ID) and dbkey, the number of dbkeys needed to reach each data record, the maximum and minimum I/O path lengths needed to reach the data record, and the specific dbkey for the data record.

Command Parameters

root-file-spec

The file specification for the database root file to be analyzed. The default file extension is .rdb.

index-name[,...]

The name of the index for which you want information. The default is all enabled indexes. If you want information about a disabled index, you must specify it by name. This parameter is optional. An indirect file reference can be used.

Command Qualifiers

Areas[=storage-area-list]

Specifies the storage areas to be analyzed. You can specify each storage area by name or by the area's ID number.

If you are interested in the placement information for a particular index, specify the area where the data resides, not where the index resides. For example, if you are interested in the placement information for the SH_EMPLOYEE_ID index of the mf_personnel database, you should specify SALARY_HISTORY as the storage area (which is where the data resides), not RDB\$SYSTEM (which is where the index resides).

If you do not specify the Areas qualifier, or if you specify the Areas qualifier but do not provide a storage-area-list, information for all the storage areas is displayed.

If you specify more than one storage area, separate the storage area names or ID numbers in the storage-area-list with a comma and enclose the list within parentheses.

If you specify more than one storage area with the Areas qualifier, the analysis Oracle RMU provides is a summary for all the specified areas. The analysis is not broken out into separate sections for each specified storage area. To get index information for a specific storage area, issue the RMU Analyze Placement command, specifying only that area with the Areas qualifier.

The Areas qualifier can be used with an indirect file reference. See Section 1.3 for more information.

1.9 RMU Analyze Placement Command

The Areas qualifier (without a storage-area-list) is the default.

Binary_Output[=file-option-list]

Nobinary_Output

Specifying the Binary_Output qualifier allows you to store the summary results in a binary file, and to create a record definition file that is compatible with the data dictionary for the binary output file. The binary output file can be loaded into an Oracle Rdb database by using the RMU Load command with the Record_Definition qualifier that can then be used by a user-written management application or procedure. The binary output can also be used directly by the user-written application or procedure.

The valid file options are:

- File=file-spec

The File option causes the RMU Analyze Placement command data to be stored in an RMS file that contains a fixed-length binary record for each index analyzed. The default file extension for the binary output file is .unl. The following command creates the binary output file analyze_out.unl:

```
$ RMU/ANALYZE/PLACEMENT -
_ $ /BINARY_OUTPUT=FILE=ANALYZE_OUT MF_PERSONNEL.RDB
```

- Record_Definition=file-spec

The Record_Definition option causes the RMU Analyze Placement command data record definition to be stored in an RMS file. The output file contains the record definition in a subset of the data dictionary command format. The default file extension for the record definition output file is .rrd. Refer to Appendix A for a description of .rrd files. The following command creates the output file analyze_out.rrd:

```
$ RMU/ANALYZE/PLACEMENT -
_ $ /BINARY_OUTPUT=RECORD_DEFINITION=ANALYZE_OUT MF_PERSONNEL.RDB
```

You can specify both file options in one command by separating them with a comma and enclosing them within parentheses, as follows:

```
$ RMU/ANALYZE/PLACEMENT/BINARY_OUTPUT= (
_ $ (FILE=ANALYZE_OUT,RECORD_DEFINITION=ANALYZE_OUT) -
_ $ MF_PERSONNEL.RDB
```

The default is the Nobinary_Output qualifier, which does not create an output file.

1.9 RMU Analyze Placement Command

Exclude=Metadata

Excludes information from the RMU Analyze Placement command data. When you specify the Exclude=Metadata qualifier, information on all the Oracle Rdb indexes (for example, the RDB\$NDX_REL_NAME_NDX and RDB\$COLLATIONS_NDX indexes) is excluded from the RMU Analyze Placement command output. When you do not specify the Exclude qualifier, data is provided for all indexes in the database.

Data is accumulated for the indexes excluded with the Exclude qualifier, but the data is excluded from the RMU Analyze Placement command output.

You cannot specify the Exclude qualifier and one or more index names in the same RMU Analyze Placement command.

Option=type

Specifies the type of information and level of detail the analysis will include. Three types of output are available:

- Normal
Output includes only summary information. Normal is the default.
- Full
Output includes histograms and summary information.
- Debug
Output includes internal information about the data, histograms, and summary information. Output also displays uncompressed index keys from compressed indexes. The hexadecimal output is that of the uncompressed index key. However, the lengths shown are of the compressed index key. For more information on RMU Analyze Placement and the display of index keys, refer to the *Oracle Rdb7 Guide to Database Performance and Tuning*.

Output=file-name

Specifies the name of the file where output will be sent. The default file type is .lis. If you do not specify the Output qualifier, the default output is SYS\$OUTPUT.

Transaction_Type=option

Allows you to specify the transaction mode for the transactions used to perform the analyze operation. Valid options are:

- Automatic
- Read_Only
- Noread_Only

1.9 RMU Analyze Placement Command

You must specify an option if you use this qualifier.

If you do not use any form of this qualifier, the `Transaction_Type=Automatic` qualifier is the default. This qualifier specifies that Oracle RMU is to determine the transaction mode used for the analyze operation. If any storage area in the database (including those not accessed for the analyze operation) has snapshots disabled, the transactions used for the analyze operation are set to read/write mode. Otherwise, the transactions are set to read-only mode.

The `Transaction_Type=Read_Only` qualifier specifies the transactions used to perform the analyze operation be set to read-only mode. When you explicitly set the transaction type to read-only, snapshots need not be enabled for all storage areas in the database, but must be enabled for those storage areas that are analyzed. Otherwise, you receive an error and the analyze operation fails.

You might select this option if not all storage areas have snapshots enabled and you are analyzing objects that are stored only in storage areas with snapshots enabled. In this case, using the `Transaction_Type=Read_Only` qualifier allows you to perform the analyze operation and impose minimal locking on other users of the database.

The `Transaction_Type=Noread_Only` qualifier specifies that the transactions used for the analyze operation be set to read/write mode. You might select this option if you want to eradicate the growth of snapshot files that occurs during a read-only transaction and are willing to incur the cost of increased locking that occurs during a read/write transaction.

Usage Notes

- To use the RMU Analyze Placement command for a database, you must have the `RMU$ANALYZE` privilege in the root file ACL for the database or the OpenVMS `SYSPRV` or `BYPASS` privilege.
- When the RMU Analyze Placement command is issued for a closed database, the command executes without other users being able to attach to the database.
- The following RMU Analyze Placement command directs the results into an RMS record definition file called `placement.rrd` that is compatible with the data dictionary:

1.9 RMU Analyze Placement Command

```
$ RMU/ANALYZE/PLACEMENT/BINARY_OUTPUT=RECORD_DEFINITION=PLACEMENT.RRD -
_$ MF_PERSONNEL
$!
$! Display the placement.rrd file created by the previous command:
$ TYPE PLACEMENT.RRD

DEFINE FIELD RMU$DATE DATATYPE IS DATE.
DEFINE FIELD RMU$INDEX_NAME DATATYPE IS TEXT SIZE IS 32.
DEFINE FIELD RMU$RELATION_NAME DATATYPE IS TEXT SIZE IS 32.
DEFINE FIELD RMU$LEVEL DATATYPE IS SIGNED WORD.
DEFINE FIELD RMU$FLAGS DATATYPE IS SIGNED WORD.
DEFINE FIELD RMU$COUNT DATATYPE IS F_FLOATING.
DEFINE FIELD RMU$DUPLICATE_COUNT DATATYPE IS F_FLOATING.
DEFINE FIELD RMU$KEY_COUNT DATATYPE IS F_FLOATING.
DEFINE FIELD RMU$DUPLICATE_KEY_COUNT DATATYPE IS F_FLOATING.
DEFINE FIELD RMU$DATA_COUNT DATATYPE IS F_FLOATING.
DEFINE FIELD RMU$DUPLICATE_DATA_COUNT DATATYPE IS F_FLOATING.
DEFINE FIELD RMU$TOTAL_KEY_PATH DATATYPE IS F_FLOATING.
DEFINE FIELD RMU$TOTAL_PAGE_PATH DATATYPE IS F_FLOATING.
DEFINE FIELD RMU$TOTAL_BUFFER_PATH DATATYPE IS F_FLOATING.
DEFINE FIELD RMU$MAX_KEY_PATH DATATYPE IS F_FLOATING.
DEFINE FIELD RMU$MAX_PAGE_PATH DATATYPE IS F_FLOATING.
DEFINE FIELD RMU$MIN_BUF_PATH DATATYPE IS F_FLOATING.
DEFINE RECORD RMU$ANALYZE_PLACEMENT.
```

- The following list describes each of the fields in the placement.rrd record definition:
 - **RMU\$DATE**
Contains the date that the analyze operation was done
 - **RMU\$INDEX_NAME**
Contains the name of the index that was analyzed
 - **RMU\$RELATION_NAME**
Contains the name of the table for which the index is defined
 - **RMU\$LEVEL**
Contains the maximum number of index levels
 - **RMU\$FLAGS**
The six possible values in this field have the following meanings:
 - * 0—Index is a sorted and not unique index
 - * 1—Index is sorted and unique
 - * 2—Index is hashed and not unique
 - * 3—Index is hashed and unique

1.9 RMU Analyze Placement Command

* 4—Index is ranked sorted and not unique

* 5—Index is ranked sorted and unique

The RMU Analyze Placement command uses the RMU\$FLAGS bits shown in Table 1–3 for describing specific index information.

Table 1–3 RMU\$FLAGS Bits Used by the RMU Analyze Placement Command

Bit Offset	Meaning
0	Unique index if true
1	Hashed index if true
2	Ranked sorted index if true

- RMU\$COUNT
Contains the number of index nodes
- RMU\$DUPLICATE_COUNT
Contains the number of duplicate records
- RMU\$KEY_COUNT
Contains the number of keys
- RMU\$DUPLICATE_KEY_COUNT
Contains the number of duplicate keys
- RMU\$DATA_COUNT
Contains the number of records
- RMU\$DUPLICATE_DATA_COUNT
Contains the number of duplicate records
- RMU\$TOTAL_KEY_PATH
Contains the total number of keys touched to access all the records
- RMU\$TOTAL_PAGE_PATH
Contains the total number of pages touched to access all the records
- RMU\$TOTAL_BUFFER_PATH
Contains the total number of buffers touched to access all the records
- RMU\$MAX_KEY_PATH
Contains the largest number of keys touched to access any of the records

1.9 RMU Analyze Placement Command

- `RMU$MAX_PAGE_PATH`
Contains the largest number of pages touched to access any of the records
- `RMU$MIN_BUF_PATH`
Contains the smallest number of buffers touched to access any of the records

Examples

Example 1

The following command provides information on row storage relative to the `DEPARTMENTS_INDEX` index of the sample personnel database:

```
$ RMU/ANALYZE/PLACEMENT MF_PERSONNEL.RDB DEPARTMENTS_INDEX
```

```
-----  
Indices for database - DISK1:[DB]MF_PERSONNEL.RDB;  
-----  
Index DEPARTMENTS_INDEX for relation DEPARTMENTS duplicates not allowed  
Levels: 1, Nodes: 1, Keys: 26, Records: 26  
Maximum path length -- DBkeys: 2, IO range: 1 to 2  
Average path length -- DBkeys: 2.00, IO range: 1.00 to 1.65  
-----
```

1.10 RMU Backup Command

1.10 RMU Backup Command

Creates a backup copy of the database and places it in a file. If necessary, you can later use the RMU Restore command to restore the database to the condition it was in at the time of the backup operation.

Format

RMU/Backup root-file-spec backup-file-spec

Command Qualifiers

`/[No]Accept_Label`
`/[No]Acl`
`/Active_IO=max-writes`
`/Allocation=blocks`
`/Block_Size=integer`
`/[No]Checksum_Verification`
`/[No]Compression[=LZSS|Huffman]`
`/Crc[=Autodin_II]`
`/Crc=Checksum`
`/Nocrc`
`/Density=(density-value,[No]Compaction)`
`/Disk_File[=options]`
`/Encrypt=(Value=|Name=)[,Algorithm=]`
`/Exclude[=storage-area[,...]]`
`/[No]Execute`
`/Extend_Quantity=number-blocks`
`/[No]Group_Size=interval`
`/Include[=storage-area[,...]]`
`/[No]Incremental`

Defaults

`/Noaccept_Label`
`/Acl`
`/Active_IO=3`
`None`
`See description`
`/Checksum_Verification`
`/Nocompression`
`See description`
`See description`
`See description`
`See description`
`None`
`See description`
`See description`
`See description`
`/Extend_Quantity=2048`
`See description`
`See description`
`/Noincremental`

1.10 RMU Backup Command

/Incremental={By_ArealComplete}	None
/Journal=file-name	See description
/Label=(label-name-list)	See description
/Librarian=[options]	None
/List_Plan=output-file	See description
/Loader_Synchronization[=Fixed]	See description
/Lock_Timeout=seconds	See description
/[No]Log[=Brief Full]	Current DCL verify switch
/Master	See description
/[No]Media_Loader	See description
/No_Read_Only	See description
/[No]Online	/Noonline
/Owner=user-id	See description
/Page_Buffers=number-buffers	/Page_Buffers=2
/Parallel=(Executor_Count=n[,options])	See description
/Prompt={Automatic Operator Client}	See description
/Protection[=file-protection]	See description
/[No]Quiet_Point	/Quiet_Point
/Reader_Thread_Ratio=integer	See description
/Restore_Options=file-name	None
/[No]Rewind	/Norewind
/[No]Scan_Optimization	See description
/Tape_Expiration=date-time	The current time

Description

The RMU Backup command copies information contained in a database to a file. It provides a number of options that allow you to determine the following:

- Whether to perform a parallel backup operation.
When you specify a parallel backup operation, you must back up to tape or multiple disks. The Parallel Backup Monitor allows you to monitor the progress of a parallel backup operation.
- Whether to back up the database to disk or tape.
- The extent (how much of the database) to back up.

The backup operation uses a multithreaded process to optimize the performance of the backup operation. See the *Oracle Rdb Guide to Database Maintenance* for a complete description of how multithreading works.

1.10 RMU Backup Command

A parallel backup operation, in addition to using multithreaded processes, uses a coordinator executor and multiple worker executors (subprocesses) to enhance the speed of the backup operation. You can also direct each worker executor to run on a different node within a cluster to further enhance the speed of the operation. You must have Oracle SQL/Services installed and running to perform a parallel backup operation.

See the *Oracle Rdb Guide to Database Maintenance* for information on when a parallel backup operation is most useful.

Use the Parallel qualifier to indicate to Oracle RMU that you want to perform a parallel backup operation. Use the Noexecute and List_Plan qualifiers to generate a Backup plan file. A Backup plan file records the backup options and specifications you enter on the command line in a text file. You can edit this text file to fine-tune your parallel backup operation and execute it, as needed, with the RMU Backup Plan command. Use the Statistics option to the Parallel qualifier if you want to monitor the progress of the parallel backup operation with the Parallel Backup Monitor. See the description of the Parallel, List_Plan, and Noexecute qualifiers, and the RMU Backup Plan command for details.

You cannot use the Parallel Backup Monitor to monitor the progress of a non-parallel backup operation. However, you can achieve a close approximation of this by specifying the Executor_Count=1 and the Statistics options with the Parallel qualifier. This results in a parallel backup operation with one executor and one controller that you can monitor with the Parallel Backup Monitor.

Both parallel and non-parallel backup operations allow you to perform different types of backup operations with respect to the portions of the database to be backed up, as described in Table 1-4.

1.10 RMU Backup Command

Table 1–4 RMU Backup Options

Database Page Selection	Storage Area Selection	
	Complete (All Areas)	By-Area (Selected Areas)
Full	Copies the database root (.rdb) file and all the database pages in all the storage areas in the database. This is the default backup operation. Note that you must use this type of backup prior to upgrading to a newer version of Oracle Rdb. Because this is the default operation, no qualifiers are needed to specify a full backup.	Copies the database root (.rdb) file and backs up only the database pages in the storage areas that you specify on the backup command line. All the storage areas in the database are backed up only if you specify them all (or perform a full and complete backup operation). Use the Include or Exclude qualifiers to specify the storage areas for a full by-area backup operation.
Incremental	Copies all database pages that have been updated since the latest full backup operation and the database root file. Use the Incremental (or Incremental=Complete) qualifier to specify an incremental and complete backup operation.	Copies the database root (.rdb) file and only the database pages for the specified storage areas that have changed since the latest full backup operation. Use the Include or Exclude qualifier along with the Incremental=By_Area qualifier to specify an incremental, by-area, backup operation.

Oracle Corporation recommends that you use a full backup operation to back up a database if you have made changes in the physical or logical design. Performing an incremental backup operation under these circumstances can lead to the inability to recover the database properly.

If you choose to perform a by-area backup operation, your database can be fully recovered after a system failure *only* if after-image journaling is enabled on the database. If your database has both read/write and read-only storage areas but does not have after-image journaling enabled, you should do complete backup operations (backup operations on all the storage areas in the database) at all times. Doing complete backup operations when after-image journaling is not enabled ensures that you can recover the entire database to its condition at the time of the previous backup operation.

When a full backup file is created for one or more storage areas, the date and time of the last full backup file created for those storage areas (as recorded in the backup (.rbf) file) is updated. You can display the date and time of the last full backup operation on each of the storage areas in a database by executing an RMU Dump command with the Header qualifier on the latest backup (.rbf) file for the database. The date and time displayed by this command is the date and time of the last *full* backup operation performed for the area.

1.10 RMU Backup Command

Note that an *incremental* backup operation on a storage area does *not* update the date and time for the last *full* backup operation performed on the storage area that is recorded in the backup file.

In the event of subsequent damage to the database, you can specify backup files in an RMU Restore command to restore the database to the condition it was in when you backed it up.

The RMU Backup command writes backup files in compressed format to save space. Available or free space in the database root (.rdb) file and on each database page in a storage area (.rda) file is not written to the backup file.

Note

Use only the RMU Backup command to back up all Oracle Rdb databases. Do not back up a database by using any other method (such as the DCL BACKUP command). The database root of a database is updated only when the RMU Backup command is used.

For detailed information on backing up a database to tape, see the *Oracle Rdb Guide to Database Maintenance*.

Command Parameters

root-file-spec

The name of the database root file. The root file name is also the name of the database. The default file extension is .rdb.

backup-file-spec

The file specification for the backup file. The default file extension is .rbf. Depending on whether you are performing a backup operation to magnetic tape, disk, or multiple disks, the backup file specification should be specified as follows:

- If you are backing up to magnetic tape
 - Oracle Corporation recommends that you supply a backup file name that is 17 or fewer characters in length. File names longer than 17 characters might be truncated. See the Usage Notes section for more information about backup file names that are longer than 17 characters.

1.10 RMU Backup Command

- If you use multiple tape drives, the backup-file-spec parameter must be provided with (and only with) the first tape drive name. Additional tape drive names must be separated from the first and subsequent tape drive names with commas.

See the *Oracle Rdb Guide to Database Maintenance* for more information about using multiple tape drives.

- If you are backing up to multiple or single disk files
 - It is good practice to write backup files to a device other than the devices where the database root, storage area, and snapshot files of the database are located. This way, if there is a problem with the database disks, you can still restore the database from a backup file.
 - If you use multiple disk files, the backup-file-spec parameter must be provided with (and only with) the first disk device name. Additional disk device names must be separated from the first and subsequent disk device names with commas. You must include the Disk_File qualifier. For example:

```
$ RMU/BACKUP/DISK_FILE MF_PERSONNEL.RDB -  
_$_$ DEVICE1:[DIRECTORY1]MFP.RBF,DEVICE2:[DIRECTORY2]
```

As an alternative to listing the disk device names on the command line (which, if you use several devices, can exceed the line-limit length for a command line), you can specify an options file in place of the backup-file-spec. For example:

```
$ RMU/BACKUP/DISK_FILE LARGE_DB "@DEVICES.OPT"
```

The contents of devices.opt might appear as follows:

```
DEVICE1:[DIRECTORY1]LARGE_DB.RBF  
DEVICE2:[DIRECTORY2]
```

The resulting backup files created from such an options file would be:

```
DISK1:[DIRECTORY1]LARGE_DB.RBF  
DISK2:[DIRECTORY2]LARGE_DB01.RBF
```

Note that the same directory must exist on each device before you issue the command. Also, if you forget to specify the Disk_File qualifier, you receive an error message similar to the following:

1.10 RMU Backup Command

```
$ RMU/BACKUP MF_PERSONNEL DEVICE1:[DIRECTORY1]MFP.RBF, -
_ $ DEVICE2:[DIRECTORY2]
%RMU-F-NOTBACFIL, DEVICE1:[DIRECTORY1]MFP.RBF; is not a valid
backup file
%RMU-F-FTL_BCK,Fatal error for BACKUP operation at 2-MAY-2001
09:44:57.04
```

Command Qualifiers

Accept_Label

Specifies that RMU Backup should keep the current tape label it finds on a tape during a backup operation even if that label does not match the default label or that specified with the Label qualifier. Operator notification does not occur unless the tape's protection, owner, or expiration date prohibit writing to the tape. However, a message is logged (assuming logging is enabled) and written to the backup journal file (assuming you have specified the Journal qualifier) to indicate that a label is being preserved and which drive currently holds that tape.

This qualifier is particularly useful when your backup operation employs numerous previously used (and thus labeled) tapes and you want to preserve the labels currently on the tapes. However, you are responsible for remembering the order in which tapes were written. For this reason, it is a good idea to use the Journal qualifier when you use the Accept_Label qualifier.

If you do not specify this qualifier, the default behavior of RMU Backup is to notify the operator each time it finds a mismatch between the current label on the tape and the default label (or the label you specify with the Label qualifier).

See the description of the Labels qualifier in this section for information on default labels. See Table 1–5 in the Usage Notes section for a summary of which labels are applied under a variety of circumstances.

Acl

Noacl

Specifies whether to back up the root file access control list (ACL) for a database when you back up the database. The root file ACL controls users privileges to issue Oracle RMU commands.

If you specify the Acl qualifier, the root file ACL will be backed up with the database.

If you specify the Noacl qualifier, the root file ACL will not be backed up with the database. The Noacl qualifier can be useful if you plan to restore the database on a system where the identifiers in the current root file ACL will not be valid.

1.10 RMU Backup Command

The default is the Acl qualifier.

Active_IO=max-writes

Specifies the maximum number of write operations to a backup device that the RMU Backup command will attempt simultaneously. This is not the maximum number of write operations in progress; that value is the product of active system I/O operations and the number of devices being written to simultaneously.

The value of the Active_IO qualifier can range from 1 to 5. The default value is 3. Values larger than 3 can improve performance with some tape drives.

Allocation=blocks

Specifies the size, in blocks, which the backup file is initially allocated. The minimum value for the number-blocks parameter is 1; the maximum value allowed is 2147483647. If you do not specify the Allocation_Quantity qualifier, the Extend_Quantity value effectively controls the file's initial allocation.

This qualifier cannot be used with backup operations to tape.

Block_Size=integer

Specifies the maximum record size for the backup file. The size can vary between 2048 and 65,024 bytes. The default value is device dependent. The appropriate block size is a compromise between tape capacity and error rate. The block size you specify must be larger than the largest page length in the database.

Checksum_Verification

Nochecksum_Verification

The Checksum_Verification qualifier requests that the RMU Backup command verify the checksum stored on each database page before the backup operation is applied, thereby providing end-to-end error detection on the database I/O. The default value is Checksum_Verification.

Oracle Corporation recommends that you accept this default behavior for your applications. The default behavior prevents you from including corrupt database pages in backup files and optimized .aij files. Without the checksum verifications, corrupt data pages in these files are not detected when the files are restored. The corruptions on the restored page may not be detected until weeks or months after the backup file is created, or it is possible the corruption may not be detected at all.

The Checksum_Verification qualifier uses additional CPU resources but provides an extra measure of confidence in the quality of the data that is backed up.

1.10 RMU Backup Command

Note that if you specify the Nochecksum qualifier, and undetected corruptions exist in your database, the corruptions are included in your backup file and are restored when you restore the backup file. Such a corruption might be difficult to recover from, especially if it is not detected until long after the restore operation is performed.

Compression

Compression=LZSS

Compression=Huffman

Nocompression

Allows you to specify the compression method to use before writing data to the backup file. This reduces performance, but may be justified when the backup file is a disk file, or is being backed up over a busy network, or is being backed up to a tape drive that does not do its own compression. You probably do not want to specify the Compression qualifier when you are backing up a database to a tape drive that does its own compression; in some cases doing so can actually result in a larger file.

If you specify the Compression qualifier without a value, the default is Compression=LZSS.

Crc[=Autodin_II]

Uses the AUTODIN-II polynomial for the 32-bit cyclic redundancy check (CRC) calculation and provides the most reliable end-to-end error detection. This is the default for NRZ/PE (800/1600 bits/inch) tape drives.

If you enter only Crc as the qualifier, RMU Backup assumes you are specifying Crc=Autodin_II.

Crc=Checksum

Uses one's complement addition, which is the same computation used to do a checksum of the database pages on disk. This is the default for GCR (6250 bits/inch) tape drives and for TA78, TA79, and TA81 tape drives.

The Crc=Checksum qualifier allows detection of data errors.

Nocrc

Disables end-to-end error detection. This is the default for TA90 (IBM 3480 class) drives.

Note

The overall effect of the Crc=Autodin_II, Crc=Checksum, and Nocrc qualifier defaults is to make tape reliability equal to that of a disk. If you retain your tapes longer than 1 year, the Nocrc default might

1.10 RMU Backup Command

not be adequate. For tapes retained longer than 1 year, use the `Crc=Checksum` qualifier.

If you retain your tapes longer than 3 years, you should always use the `Crc=Autodin_II` qualifier.

Tapes retained longer than 5 years could be deteriorating and should be copied to fresh media.

See the *Oracle Rdb Guide to Database Maintenance* for details on using the `Crc` qualifiers to avoid underrun errors.

Density=(density-value,[No]Compaction)

Specifies the density at which the output volume is to be written. The default value is the format of the first volume (the first tape you mount). You do not need to specify this qualifier unless your tape drives support data compression or more than one recording density.

The `Density` qualifier is applicable only to tape drives. `RMU Backup` returns an error message if this qualifier is used and the target device is not a tape drive.

If you specify a density value, `RMU Backup` assumes that all tape drives can accept that value.

If your systems are running `OpenVMS` versions prior to 7.2-1, specify the `Density` qualifier as follows:

- For `TA90E`, `TA91`, and `TA92` tape drives, specify the number in bits per inch as follows:
 - `Density = 70000` to initialize and write tapes in the compacted format.
 - `Density = 39872` or `Density = 40000` for the noncompacted format.
- For `SCSI` (Small Computer System Interface) tape drives, specify `Density = 1` to initialize and write tapes by using the drive's hardware data compression scheme.
- For other types of tape drives you can specify a supported density value between 800 and 160000 bits per inch.
- For all tape drives, specify `Density = 0` to initialize and write tapes at the drive's standard density.

Do not use the `Compaction` or `NoCompaction` keyword for systems running `OpenVMS` versions prior to 7.2-1. On these systems, compression is determined by the density value and cannot be specified.

1.10 RMU Backup Command

Oracle RMU supports the OpenVMS tape density and compression values introduced in OpenVMS Version 7.2-1. The following table lists the added density values supported by Oracle RMU.

DEFAULT	800	833	1600
6250	3480	3490E	TK50
TK70	TK85	TK86	TK87
TK88	TK89	QIC	8200
8500	8900	DLT8000	
SDLT	SDLT320		
DDS1	DDS2	DDS3	DDS4
AIT1	AIT2	AIT3	AIT4
COMPACTION	NOCOMPACTION		

If the OpenVMS Version 7.2-1 density values and the previous density values are the same (for example, 800, 833, 1600, 6250), the specified value is interpreted as an OpenVMS Version 7.2-1 value if the tape device driver accepts them, and as a previous value if the tape device driver accepts previous values only.

For the OpenVMS Version 7.2-1 values that accept tape compression you can use the following syntax:

```
/DENSITY = (new_density_value, [No]Compaction)
```

In order to use the `Compaction` or `NoCompaction` keyword, you must use one of the following density values that accepts compression:

DEFAULT	3480	3490E	8200
8500	8900	TK87	TK88
TK89	DLT8000	SDLT	SDLT320
AIT1	AIT2	AIT3	AIT4
DDS1	DDS2	DDS3	DDS4

Refer to the OpenVMS documentation for more information about density values.

Disk_File[=(options)]

Specifies that you want to perform a multithreaded backup operation to disk files, floppy disks, or other disks external to the PC. You can use the following keywords with the `Disk_File` qualifier:

- `Writer_Threads`

1.10 RMU Backup Command

Specifies the number of threads that Oracle RMU should use when performing a multithreaded backup operation to disk files. You can specify no more than one writer thread per device specified on the command line (or in the command parameter options file). By default, one writer thread is used.

This qualifier and all qualifiers that control tape operations (`Accept_Label`, `Density`, `Label`, `Loader_Synchronization`, `Master`, `Media_Loader`, `Rewind`, and `Tape_Expiration`) are mutually exclusive.

Encrypt={Value= | Name=}[,Algorithm=]

The `Encrypt` qualifier encrypts the save set file of a database backup.

Specify a key value as a string or, the name of a predefined key. If no algorithm name is specified the default is `DESCBC`. For details on the `Value`, `Name` and `Algorithm` parameters see `HELP ENCRYPT`.

This feature requires the OpenVMS `Encrypt` product to be installed and licensed on this system.

Exclude[=storage-area[,...]]

Specifies the storage areas that you want to exclude from the backup file. If you specify neither the `Exclude` nor the `Include` qualifier with the `RMU Backup` command, or if you specify the `Exclude` qualifier but do not specify a list of storage area names, a full and complete backup operation is performed on the database. This is the default behavior.

If you specify a list of storage area names with the `Exclude` qualifier, `RMU Backup` excludes those storage areas from the backup file and includes all of the other storage areas. If you specify more than one database storage area in the `Exclude` qualifier, place a comma between each storage area name and enclose the list of names within parentheses.

Use the `Exclude=*` qualifier to indicate that you want only the database root file to be backed up. Note that a backup file created with the `Exclude=*` qualifier can be restored only with the `RMU Restore Only_Root` command.

You can use an indirect command file as shown in the following example:

```
$ RMU/BACKUP/EXCLUDE="@EXCLUDE_AREAS.OPT" -  
_ $ MF_PERSONNEL.RDB PARTIAL_MF_PERS.RBF  
%RMU-I-NOTALLARE, Not all areas will be included in this backup file
```

See Section 1.3 for more information on indirect command files.

1.10 RMU Backup Command

If you use the Exclude qualifier with a list of storage area names, your backup file will be a by-area backup file because the Exclude qualifier causes database storage areas to be excluded from the backup file. The following example shows the informational message you receive if you do not back up all of the areas in the database:

```
%RMU-I-NOTALLARE, Not all areas will be included in this backup file
```

By using the RMU Backup and RMU Restore commands, you can back up and restore selected storage areas of your database. This Oracle RMU backup and restore by-area feature is designed to:

- Speed recovery when corruption occurs in some (not all) of the storage areas of your database
- Reduce the time needed to perform backup operations because some data (data in read-only storage areas, for example) does not need to be backed up with every backup operation performed on the database

If you plan to use the RMU Backup and RMU Restore commands to back up and restore only selected storage areas for a database, you should perform full and complete backup operations on the database at regular intervals.

If you plan to back up and restore only selected storage areas of a database, Oracle Corporation also strongly recommends that you enable after-image journaling for the database. This ensures that you can recover all of the storage areas in your database if a system failure occurs.

If you *do not* have after-image journaling enabled and one or more of the areas restored with the RMU Restore command are not consistent with the unrestored storage areas, Oracle Rdb does not allow any transaction to use the storage areas that are not consistent in the restored database. In this situation, you can return to a working database by restoring the database, using the backup file from the last full and complete backup operation of the database storage areas. However, any changes made to the database since the last full and complete backup operation are not recoverable.

If you *do* have after-image journaling enabled, use the RMU Recover command (or the Restore command with the Recover qualifier) to apply transactions from the .aij file to storage areas that are not consistent after the RMU Restore command completes; that is, storage areas that are not in the same state as the rest of the restored database. You cannot use these areas until you recover the database. When the RMU Recover command completes, your database will be consistent and usable.

1.10 RMU Backup Command

Using the Exclude or Include qualifier gives you greater flexibility for your backup operations, along with increased file management and recovery complexity. Users of large databases might find the greater flexibility of the backup operation to be worth the cost of increased file management and recovery complexity.

You cannot specify the Exclude=area-list and Include=area-list qualifiers in the same RMU Backup command.

Execute

Noexecute

Use the Execute and Noexecute qualifiers with the Parallel and List_Plan qualifiers to specify whether or not the backup plan file is to be executed.

The following list describes the effects of using the Execute and Noexecute qualifier:

- Execute
Creates, verifies, and executes a backup list plan
- Noexecute
Creates and verifies, but does not execute a backup list plan.

The verification determines such things as whether the storage areas listed in the plan file exist in the database.

The Execute and Noexecute qualifiers are only valid when the Parallel and List_Plan qualifiers are also specified.

If you specify the Execute or Noexecute qualifier without the List_Plan and Parallel qualifiers, RMU Backup generates and verifies a temporary backup list plan, but then deletes the backup list plan and returns a fatal error message.

By default, the backup plan file is executed when you issue an RMU Backup command with the Parallel and List_Plan qualifiers.

Extend_Quantity=number-blocks

Sets the size, in blocks, by which the backup file can be extended. The minimum value for the number-blocks parameter is 1; the maximum value is 65535. If you do not specify the Extend_Quantity qualifier, the default number of blocks by which an on-disk backup file can be extended is 2048 blocks.

This qualifier cannot be used with backup operations to tape.

1.10 RMU Backup Command

Group_Size=interval

Nogroup_Size

Specifies the frequency at which XOR recovery blocks are written to tape. The group size can vary from 0 to 100. Specifying a group size of zero or specifying the `Nogroup_Size` qualifier results in no XOR recovery blocks being written. The `Group_Size` qualifier is only applicable to tape, and its default value is device dependent. RMU Backup returns an error message if this qualifier is used and the target device is not a tape device.

Include[=storage-area[,...]]

Specifies storage areas that you want to include in the backup file. If you specify neither the `Include` nor the `Exclude` qualifier with the RMU Backup command, a full and complete backup operation is performed on the database by default. You can specify the `Include=*` qualifier to indicate that you want all storage areas included in the backup file, but this is unnecessary because this is the default behavior. The default behavior is performed also when you specify the `Include` qualifier without specifying a list of storage area names.

If you specify a list of storage area names with the `Include` qualifier, Oracle RMU includes those storage areas in the backup operation and excludes all of the other storage areas. If you specify more than one database storage area in the `Include` qualifier, place a comma between each storage area name and enclose the list of names within parentheses.

You cannot specify the `Exclude=area-list` and `Include=area-list` qualifiers in the same RMU Backup command.

If you use the `Include` qualifier, your backup operation will be a by-area backup operation because the areas not specified with the `Include` qualifier are excluded from the backup file. If you do not back up all of the areas in the database, you receive the following informational message:

```
%RMU-I-NOTALLARE, Not all areas will be included in this backup file
```

By using the RMU Backup and RMU Restore commands, you can back up and restore selected storage areas of your database. This Oracle RMU backup and restore by area feature is designed to:

- Speed recovery when corruption occurs in some (not all) of the storage areas of your database
- Reduce the time needed to perform backup operations because some data (data in read-only storage areas, for example) does not need to be backed up with every backup operation performed on the database

1.10 RMU Backup Command

See the description of the Exclude qualifier for information on the implications of using these commands to back up and restore selected areas of your database.

The Include qualifier can be used with indirect file references. See Section 1.3 for more information.

Incremental[=By_Area or Complete]

Noincremental

Determines the extent of the backup operation to be performed. The four possible options are:

- **Noincremental**
If you do not specify any of the possible Incremental qualifier options, the default is the Noincremental qualifier. With the Noincremental qualifier, a full backup operation is performed on the database.
- **Incremental**
If you specify the Incremental qualifier, an incremental backup of all the storage areas that have changed since the last full and complete backup operation on the database is performed.
- **Incremental=By_Area**
If you specify the Incremental=By_Area qualifier, an incremental backup operation is performed. The Incremental=By_Area qualifier backs up those database pages that have changed in each selected storage area since the last full backup operation was performed on the area. The last full backup operation performed on the area is the later of the following:
 - The last full and complete backup operation performed on the database
 - The last full by-area backup operation performed on the areaWith an incremental by-area backup operation, each storage area backed up might contain changes for a different time interval, which can make restoring multiple storage areas more complex.
- **Incremental=Complete**
If you specify the Incremental=Complete qualifier, an incremental backup operation on all of the storage areas that have changed since the last full and complete backup operation on the database is performed. Selecting the Incremental=Complete qualifier is the same as selecting the Incremental qualifier.

Following a full database backup operation, each subsequent incremental backup operation replaces all previous incremental backup operations.

1.10 RMU Backup Command

The following two messages are meant to provide an aid for designing more effective backup strategies. They are printed as part of the per-area summary statistics, and they provide a guide to the incremental benefit of the incremental operation:

- “Est. cost to backup relative to a full backup is x.yy”
- “Est. cost to restore relative to a full restore is x.yy”

These estimates are only approximate and reflect the disk input/output (I/O) cost for the backup or restore operations of that area. Tape I/O, CPU, and all other costs are ignored. The disk I/O costs take into account the number of I/O operations needed and the requirement for a disk head seek to perform the I/O. Each disk type has its own relative costs—transfer rate, latency, seek time—and the cost of a given sequence of I/Os is also affected by competition for the disk by other processes. Consequently, the estimates do not translate directly into “clock time.” But they should nevertheless be useful for determining the point at which the incremental operation is becoming less productive.

The relative costs can vary widely, and can be much higher than 1.00. The actual cost depends on the number and location of the pages backed up. An incremental restore operation must always follow a full restore operation, so the actual estimate of restoring the area is actually 1.00 higher than reported when that full restore operation is accounted for. The guideline that Oracle Corporation recommends is, “Perform full backup operations when the estimated cost of a restore operation approaches 2.00.”

Journal=file-name

Allows you to specify a journal file to be used to improve tape performance during a restore operation. (This is not to be confused with an after-image journal file.)

As the backup operation progresses, RMU Backup creates the journal file and writes to it a description of the backup operation containing identification of the tape drive names and the tape volumes and their contents. The default file extension is .jnl.

The journal file must be written to disk; it cannot be written to tape along with the backup file. (Although you can copy the disk file to tape after it is written, if desired.)

This journal file is used with the RMU Restore and the RMU Dump Backup commands to optimize their tape utilization.

1.10 RMU Backup Command

Label=(label-name-list)

Specifies the 1- to 6-character string with which the volumes of the backup file are to be labeled. The Label qualifier is applicable only to tape volumes. You must specify one or more label names when you use the Label qualifier.

If you do not specify the Label (or Accept_Label) qualifier, RMU Backup labels the first tape used for a backup operation with the first 6 characters of the backup file name. Subsequent default labels are the first 4 characters of the backup file name appended with a sequential number. For example, if your backup file is my_backup.rbf, the default tape labels are my_bac, my_b01, my_b02, and so on.

When you reuse tapes, RMU Backup compares the label currently on the tape to the label or labels you specify with the Label qualifier. If there is a mismatch between the existing label and a label you specify, RMU Backup sends a message to the operator asking if the mismatch is acceptable (unless you also specify the Accept_Labels qualifier).

If desired, you can explicitly specify the list of tape labels for multiple tapes. If you list multiple tape label names, separate the names with commas and enclose the list of names within parentheses. If you are reusing tapes be certain that you load the tapes so that the label RMU Backup expects and the label on each tape will match, or be prepared for a high level of operator intervention. Alternatively, you can specify the Accept_Label qualifier. In this case, the labels you specify with the Label qualifier are ignored if they do not match the labels currently on the tapes and no operator intervention occurs.

If you specify fewer labels than are needed, RMU Backup generates labels based on the format you have specified. For example, if you specify Label=TAPE01, RMU Backup labels subsequent tapes as TAPE02, TAPE03, and so on up to TAPE99. Thus, many volumes can be preloaded in the cartridge stacker of a tape drive. The order is not important because RMU Backup relabels the volumes. An unattended backup operation is more likely to be successful if all the tapes used do not have to be mounted in a specific order.

Once the backup operation is complete, externally mark the tapes with the appropriate label so that the order can be maintained for the restore operation. Be particularly careful if you are allowing RMU Backup to implicitly label second and subsequent tapes and you are performing an unattended backup operation. Remove the tapes from the drives in the order in which they were written. Apply labels to the volumes following the logic of implicit labeling (for example, TAPE02, TAPE03, and so on).

1.10 RMU Backup Command

Oracle recommends you use the Journal qualifier when you employ implicit labeling in a multidrive, unattended backup operation. The journal file records the volume labels that were written to each tape drive. The order in which the labels were written is preserved in the journal. Use the RMU Dump Backup command to display a listing of the volumes written by each tape drive.

You can use an indirect file reference with the Label qualifier. See Section 1.3 for more information on using indirect file references. See Table 1–5 in the Usage Notes section for a summary of which labels are applied under a variety of circumstances.

Librarian[=options]

Use the Librarian qualifier to back up files to data archiving software applications that support the Oracle Media Management interface. The backup file name specified on the command line identifies the stream of data to be stored in the Librarian utility. If you supply a device specification or a version number it will be ignored.

You can use the Librarian qualifier for parallel backup operations. The Librarian utility should be installed and available on all nodes on which the parallel backup operation executes.

The Librarian qualifier accepts the following options:

- **Writer_Threads=n**

Use the Writer_Threads option to specify the number of backup data streams to write to the Librarian utility. The value of *n* can be from 1 to 99. The default is one writer thread.

Each writer thread for a backup operation manages its own stream of data. Therefore, each thread uses a unique backup file name. The unique names are generated by incrementing the number added to the end of the backup file name. For example, if you specify the following Oracle RMU Backup command:

```
$RMU/ BACKUP /LIBRARIAN=(WRITER_THREADS=3) /LOG DB FILENAM.RBF
```

The following backup file data stream names are generated:

```
FILENAME.RBF  
FILENAME.RBF02  
FILENAME.RBF03
```

Because each data stream must contain at least one database storage area, and a single storage area must be completely contained in one data stream, if the number of writer threads specified is greater than the number of storage areas, it is set equal to the number of storage areas.

1.10 RMU Backup Command

- `Trace_file=file-specification`
The Librarian utility writes trace data to the specified file.
- `Level_Trace=n`
Use this option as a debugging tool to specify the level of trace data written by the Librarian utility. You can use a pre-determined value of 0, 1, or 2, or a higher value defined by the Librarian utility. The pre-determined values are :
 - Level 0 traces all error conditions. This is the default.
 - Level 1 traces the entry and exit from each Librarian function.
 - Level 2 traces the entry and exit from each Librarian function, the value of all function parameters, and the first 32 bytes of each read/write buffer, in hexadecimal.
- `Logical_Names=(logical_name=equivalence-value,...)`
You can use this option to specify a list of process logical names that the Librarian utility can use to specify catalogs or archives where Oracle Rdb backup files are stored, Librarian debug logical names, and so on. See the specific Librarian documentation for the definition of logical names. The list of process logical names is defined by Oracle RMU prior to the start of any Oracle RMU command that accesses the Librarian utility.

The following OpenVMS logical names must be defined for use with a Librarian utility before you execute an Oracle RMU backup or restore operation. Do not use the `Logical_Names` option provided with the Librarian qualifier to define these logical names.

- `RMU$LIBRARIAN_PATH`
This logical name must be defined so that the shareable Librarian image can be loaded and called by Oracle RMU backup and restore operations. The translation must include the file type (for example, `.exe`), and must not include a version number. The shareable Librarian image must be an installed (known) image. See the Librarian utility documentation for the name and location of this image and how it should be installed. For a parallel RMU backup, define `RMU$LIBRARIAN_PATH` as a system-wide logical name so that the multiple processes created by a parallel backup can all translate the logical.

```
$ DEFINE /SYSTEM /EXECUTIVE_MODE -  
_$_ RMU$LIBRARIAN_PATH librarian_shareable_image.exe
```
- `RMU$DEBUG_SBT`

1.10 RMU Backup Command

This logical name is not required. If it is defined, Oracle RMU will display debug tracing information messages from modules that make calls to the Librarian shareable image. For a parallel RMU backup, the `RMU$DEBUG_SBT` logical should be defined as a system logical so that the multiple processes created by a parallel backup can all translate the logical.

The following lines are from a backup plan file created by the `RMU Backup /Parallel/Librarian` command:

```
Backup File = MF_PERSONNEL.RBF
Style = Librarian
Librarian_trace_level = #
Librarian_logical_names = (-
    logical_name_1=equivalence_value_1, -
    logical_name_2=equivalence_value_2)
Writer_threads = #
```

The "Style = Librarian" entry specifies that the backup is going to a Librarian utility. The "Librarian_logical_names" entry is a list of logical names and their equivalence values. This is an optional parameter provided so that any logical names used by a particular Librarian utility can be defined as process logical names before the backup or restore operation begins. For example, some Librarian utilities provide support for logical names for specifying catalogs or debugging.

You cannot use device specific qualifiers such as Rewind, Density, or Label with the Librarian qualifier because the Librarian utility handles the storage media, not Oracle RMU.

List_Plan=output-file

Specifies that RMU Backup should generate a backup plan file for a parallel backup operation and write it to the specified output file. A backup plan file is a text file that contains qualifiers that can be specified on the RMU Backup command line. Qualifiers that you do *not* specify on the command line appear as comments in the backup list plan file. In addition, the backup plan file specifies the worker executor names along with the system node, storage areas, and tape drives assigned to each worker executor.

You can use the generated backup plan file as a starting point for building a parallel backup operation to tape that is tuned for your particular configuration. The output file can be customized and then used with the RMU Backup Plan command. See Section 1.12 for details.

1.10 RMU Backup Command

If you specify the `Execute` qualifier with the `List_Plan` qualifier, the backup plan file is generated, verified, and executed. If you specify the `Noexecute` qualifier with the `List_Plan` qualifier, the backup plan file is generated and verified, but not executed.

By default, the backup plan file is executed.

The `List_Plan` qualifier is only valid when the `Parallel` qualifier is also specified.

Loader_Synchronization[=Fixed]

Allows you to preload tapes and preserve tape order to minimize the need for operator support. When you specify the `Loader_Synchronization` qualifier and specify multiple tape drives, the backup operation writes to the first set of tape volumes concurrently then waits until each tape in the set is finished before assigning the next set of tape volumes. This ensures that the tape order can be preserved in the event that a restore operation from these tapes becomes necessary.

One disadvantage with using the `Loader_Synchronization` qualifier with the `Label` qualifier is that because not all tape threads back up equal volumes of data, some threads may not need a subsequent tape to back up the assigned volume of data. In order to preserve the tape order, operator intervention may be needed to load the tapes in stages as backup threads become inactive. Use the keyword `Fixed` to force the assignment of tape labels to the drives regardless of how many tapes each drive actually uses.

The `Loader_Synchronization` qualifier does result in reduced performance. For maximum performance, no drive should remain idle, and the next identified volume should be placed on the first drive that becomes idle. However, because the order in which the drives become idle depends on many uncontrollable factors and cannot be predetermined, without the `Loader_Synchronization` qualifier, the drives cannot be preloaded with tapes. (If you do not want to relabel tapes, you might find that the `Accept_Label` qualifier is a good alternative to using the `Loader_Synchronization` qualifier. See the description of the `Accept_Label` qualifier for details.)

Because the cost of using the `Loader_Synchronization` qualifier is dependent on the hardware configuration and the system load, the cost is unpredictable. A 5% to 20% additional elapsed time for the operation is typical. You must determine whether the benefit of a lower level of operator support compensates for the loss of performance. The `Loader_Synchronization` qualifier is most useful for large backup operations.

1.10 RMU Backup Command

See the *Oracle Rdb Guide to Database Maintenance* for more information on using the `Loader_Synchronization` qualifier, including information on when this qualifier might lead to unexpected results, and details on how this qualifier interacts with other RMU Backup command qualifiers.

For very large backup operations requiring many tape volumes, managing the physical marking of tape volumes can be difficult. In such a case, you might consider using a library or archiving to automatically manage tape labeling for you.

Lock_Timeout=seconds

Determines the maximum time the backup operation will wait for the quiet-point lock during online backup operations. When you specify the `Lock_Timeout=seconds` qualifier, you must specify the number of seconds to wait for the quiet-point lock. If the time limit expires, an error is signaled and the backup operation fails.

The default value for the `Lock_Timeout=seconds` qualifier is the smaller of the value specified in the `SET TRANSACTION` statement and the value specified in `CREATE` or `ALTER DATABASE`. However, if the logical name `RDM$BIND_LOCK_TIMEOUT_INTERVAL` is defined, the value of this logical name overrides the value specified in `CREATE` or `ALTER DATABASE`. `RDM$BIND_LOCK_TIMEOUT_INTERVAL`.

When the `Lock_Timeout=seconds` qualifier is not specified, the backup operation will wait indefinitely for the quiet-point lock during an online backup operation.

The `Lock_Timeout=seconds` qualifier is ignored for offline backup operations.

Log

Log=Brief

Log=Full

Nolog

Specifies whether the processing of the command is reported to `SYS$OUTPUT`. Specify the `Log` qualifier to request that the progress of the restore operation be written to `SYS$OUTPUT`, or the `Nolog` qualifier to suppress this report. If you specify the `Log=Brief` option, which is the default if you use the `Log` option without a qualifier, the log contains the start and completion time of each storage area. If you specify the `Log=Full` option, the log also contains thread assignment and storage area statistics messages.

If you do not specify the `Log` or the `Nolog` qualifier, the default is the current setting of the DCL verify switch. (The `DCL SET VERIFY` command controls the DCL verify switch.)

1.10 RMU Backup Command

Master

Controls the assignment of tape drives to output threads by allowing you to specify a tape drive as a master tape drive. This is a positional qualifier specified with a tape drive. When the Master qualifier is used, it must be used on the first tape drive specified. When the Master qualifier is specified, all additional tape drives become slaves for that tape drive until the end of the command line, or until the next Master qualifier, whichever comes first.

If you specify the Master qualifier (without also specifying the Loader_Synchronization qualifier) on sets of tape drives, each master/slave set of tape drives will operate independently of other master/slave sets. If the Master qualifier is used on a tape drive that is not physically a master tape drive, the output performance of the backup operation will decrease.

See the *Oracle Rdb Guide to Database Maintenance* for complete details on the behavior of the master qualifier.

Media_Loader

Nomedia_Loader

Use the Media_Loader qualifier to specify that the tape device receiving the backup file has a loader or stacker. Use the Nomedia_Loader qualifier to specify that the tape device does not have a loader or stacker.

By default, if a tape device has a loader or stacker, RMU Backup should recognize this fact. However, occasionally RMU Backup does not recognize that a tape device has a loader or stacker. Therefore, when the first backup tape fills, RMU Backup issues a request to the operator for the next tape, instead of requesting the next tape from the loader or stacker. Similarly, sometimes RMU Backup behaves as though a tape device has a loader or stacker when actually it does not.

If you find that RMU Backup is not recognizing that your tape device has a loader or stacker, specify the Media_Loader qualifier. If you find that RMU Backup expects a loader or stacker when it should not, specify the Nomedia_Loader qualifier.

No_Read_Only

Allows you to specify that you do not want any of the read-only storage areas in your database to be backed up when you back up the database.

If you do not specify the No_Read_Only qualifier, any read-only storage area not specified with the Exclude qualifier will be included in the backup file. The No_Read_Only qualifier allows you to back up a database with many read-only storage areas without having to type a long list of read-only storage area names with the Exclude qualifier.

1.10 RMU Backup Command

If you specify the `No_Read_Only` qualifier, read-only storage areas are not backed up even if they are explicitly listed by the `Include` qualifier.

There is no `Read_Only` qualifier.

Online

Noonline

Specifying the `Online` qualifier permits users running active transactions at the time the command is entered to continue without interruption (unless the `Noquiet_Point` qualifier is also specified).

Any subsequent transactions that start during the online backup operation are permitted as long as the transactions do not require exclusive access to the database, a table, or any index structure currently being backed up.

To perform an online database backup operation, snapshots (either immediate or deferred) must be enabled. You can use the `Online` qualifier with the `Incremental` or `Noincremental` qualifiers. However, an online backup operation cannot be performed if `TRANSFER VIA MEMORY`, also referred to as optimized page transfer, is enabled. (See the description of the `SQL ALTER DATABASE` statement in the *Oracle Rdb SQL Reference Manual* for information on optimized page transfer.)

If you use the default, the `Noonline` qualifier, users cannot be attached to the database. If a user has invoked the database and the `RMU Backup` command is entered with the `Noonline` qualifier (or without the `Online` qualifier), an Oracle RMU error results. For example:

```
%RMU-I-FILACCERR, error opening database root file DB_DISK:MF_PERSONNEL.RDB;1  
-SYSTEM-W-ACCONFLICT, file access conflict
```

The offline backup process (specified with the `Noonline` qualifier) has exclusive access to the database and does not require snapshot (`.snp`) files in order to work. The snapshot files can be disabled when the `Noonline` qualifier is used.

Oracle Corporation recommends that you close the database (with the `RMU Close` command) when you perform the offline backup operation on a large database. If the database was opened with the `SQL OPEN IS MANUAL` statement, the `RMU Backup` command will fail unless the `RMU Close` command is used. If the database was opened with the `SQL OPEN IS AUTOMATIC` statement, the `RMU Backup` command might fail if the activity level is high (that is, users might access the database before the database is taken off line). Issuing the `RMU Close` command can force the users out of the database and give the `RMU Backup` command a chance to start; however, although recommended, issuing the `RMU Close` command is not required in this case.

1.10 RMU Backup Command

Owner_Uic=user-id

Synonymous with the Owner qualifier. See the description of the Owner qualifier.

Owner=user-id

Specifies the owner of the tape volume set. The owner is the user who will be permitted to restore the database. The user-id parameter must be one of the following types of identifier:

- A user identification code (UIC) in [group-name,member-name] alphanumeric format
- A user identification code (UIC) in [group-number,member-number] numeric format
- A general identifier, such as SECRETARIES
- A system-defined identifier, such as DIALUP

The Owner qualifier cannot be used with a backup operation to disk. When used with tapes, the Owner qualifier applies to all continuation volumes. The Owner qualifier applies to the first volume only if the Rewind qualifier is also specified.

If the Rewind qualifier is not specified, the backup operation appends the file to a previously labeled tape, so the first volume can have a protection different from the continuation volumes.

See the *Oracle Rdb Guide to Database Maintenance* for information on tape label processing.

Page_Buffers=number-buffers

Specifies the number of disk buffers assigned to each storage area thread.

The range is 2 to 5 with a default of 2.

The higher values speed up scans for changed pages during an incremental backup operation, but they exact a cost in memory usage and larger working set requirements.

Parallel=(Executor_Count=n[,options])

Specifies that you want to perform a parallel backup operation. When you issue an RMU Backup command with the parallel qualifier, RMU Backup generates a plan file. This plan file describes how the parallel backup operation should be executed. If you specify the Noexecute qualifier, the plan file is generated, but not executed. If you specify the Execute qualifier (or accept the default), the plan file is executed immediately after RMU Backup creates it.

1.10 RMU Backup Command

The `Executor_Count` specifies the number of worker executors you want to use for the parallel backup operation. The number of worker executors must be equal to or less than the number of tape drives you intend to use. If you specify `Executor_Count=1`, the result is a non-parallel backup operation that is executed using the parallel backup procedure, including creation of the plan file and a `dbserver` process.

You can specify one, both, or none of the following options:

- `Node=(node-list)`

The `Node=(node-list)` option specifies the names of the nodes in the cluster where the worker executors are to run. If more than one node is specified, all nodes must be in the same cluster and the database must be accessible from all nodes in the cluster.

In addition, for a backup operation across nodes in a cluster to be successful, whoever starts `SQL/Services` must have proxy access among all nodes involved in the backup operation (assuming you are using `DECnet`). For example, if you specify the `Nodes=(NODE1, NODE2, NODE3)` as an option to the `Parallel` qualifier, whomever started `SQL/Services` must have access from `NODE1` to `NODE2`, `NODE1` to `NODE3`, `NODE2` to `NODE1`, `NODE2` to `NODE3`, `NODE3` to `NODE1`, and `NODE3` to `NODE2`.

Separate node names in the `node-list` with commas. If you do not specify the `Nodes` option, all worker executors run on the node from which the parallel backup plan file is executed.
- `Server_Transport=(DECnet | TCP)`

To execute a parallel backup operation, `SQL/Services` must be installed on your system. By default, the `RMU Backup` command uses `DECnet` to access `SQL/Services`; if `DECnet` is not available, `RMU Backup` tries to use `TCP/IP`. Use the `Server_Transport` option to set the default behavior such that `RMU Backup` tries `TCP/IP` first. You can also use the `SQL_NETWORK_TRANSPORT_TYPE` configuration parameter to modify the default behavior. See the *Oracle Rdb Installation and Configuration Guide* for details on setting the `SQL_NETWORK_TRANSPORT_TYPE` configuration parameter.
- `Statistics`

Specifies that you want `RMU Backup` to gather statistics on the parallel backup operation for use with the `Parallel Backup Monitor`. You must invoke the `Parallel Backup Monitor`, a `Windowing` interface, to view these statistics.

1.10 RMU Backup Command

To execute a parallel backup operation, SQL/Services must be installed on your system. By default, the RMU Backup command uses DECnet to access SQL/Services; if DECnet is not available, RMU Backup tries to use TCP/IP. You can use the `SQL_NETWORK_TRANSPORT_TYPE` configuration parameter to set the default behavior such that RMU Backup tries TCP/IP first. See the *Oracle Rdb Installation and Configuration Guide* for details on setting the `SQL_NETWORK_TRANSPORT_TYPE` configuration parameter.

Note that during a parallel backup operation, all tape requests are sent to the Operator; the parallel backup operation does not send tape requests to the user who issues the Backup command. Therefore, you should issue the `DCL REPLY/ENABLE=TAPES` command from the terminal that serves the operator before issuing the RMU Backup command.

Prompt=Automatic

Prompt=Operator

Prompt=Client

Specifies where server prompts are to be sent. When you specify `Prompt=Automatic`, prompts are sent to the standard input device, and when you specify `Prompt=Operator`, prompts are sent to the server console. When you specify `Prompt=Client`, prompts are sent to the client system.

Protection[=file-protection]

Specifies the system file protection for the backup file produced by the RMU Backup command.

The default file protection varies, depending on whether you backup the file to disk or tape. This is because tapes do not allow delete or execute access and the `SYSTEM` account always has both read and write access to tapes. In addition, a more restrictive class accumulates the access rights of the less restrictive classes.

If you do not specify the Protection qualifier, the default protection is as follows:

- `S:RWED,O:RE,G,W` if the backup is to disk
- `S:RW,O:R,G,W` if the backup is to tape

If you specify the Protection qualifier explicitly, the differences in protection applied for backups to tape or disk as noted in the preceding paragraph are applied. Thus, if you specify `Protection=(S,O,G:W,W:R)`, that protection on tape becomes `(S:RW,O:RW,G:RW,W:R)`.

1.10 RMU Backup Command

Quiet_Point

Noquiet_Point

Allows you to specify that the database backup operation is to occur either immediately or when a quiet point for database activity occurs. A quiet point is defined as a point where no active update transactions are in progress in the database. Therefore, this qualifier is used with the Online qualifier.

When you specify the Noquiet_Point qualifier, RMU Backup proceeds with the backup operation as soon as the RMU Backup command is issued, regardless of any update transaction activity in progress in the database. Because RMU Backup must acquire concurrent-read locks on all physical and logical areas, the backup operation will fail if there are any active transactions with exclusive locks on a storage area. However, once RMU Backup has successfully acquired all concurrent-read storage area locks it should not encounter any further lock conflicts. If a transaction that causes Oracle Rdb to request exclusive locks is started while the backup operation is proceeding, that transaction will either wait or receive a lock conflict error, but the RMU Backup command will continue unaffected.

See the Usage Notes section for recommendations on using the Quiet_Point and Noquiet_Point qualifiers.

The default is the Quiet_Point qualifier.

Reader_Thread_Ratio=integer

Specifies the number of reader threads to be created per output thread. (Prior to Oracle Rdb release 7.1, one backup reader thread was created for each storage area in the database. For large databases, that sometimes created an unwieldy number of threads.) At most, one reader thread is assigned to a storage area and one writer thread is assigned to each backup device. If your database has numerous small storage areas, increasing the reader thread ratio may improve performance.

Restore_Options=file-name

Generates an options file designed to be used with the Options qualifier of the RMU Restore command. If you specify a full backup operation, all the storage areas will be represented in the options file. If you specify a by-area backup operation, only those areas included in the backup will be represented in the options file.

The Restore_Options file is created at the end of the backup operation.

By default, a Restore_Options file is not created. If you specify the Restore_Options qualifier and a file, but not a file extension, RMU Backup uses an extension of .opt by default.

1.10 RMU Backup Command

Rewind

Norewind

Specifies that the magnetic tape that contains the backup file will be rewound before processing begins. The tape will be initialized according to the Label and Density qualifiers. The Norewind qualifier is the default and causes the backup file to be created starting at the current logical end-of-tape (EOT).

The Rewind and Norewind qualifiers are applicable only to tape devices. RMU Backup returns an error message if these qualifiers are used and the target device is not a tape device.

Scan_Optimization

Noscan_Optimization

Specifies whether or not RMU Backup should employ scan optimizations during incremental backup operations.

By default, RMU Backup optimizes incremental backup operations by scanning regions of the database that have been updated since the last full backup operation. The identity of these regions is stored in the database. Only these regions need to be scanned for updates during an incremental backup operation. This provides a substantial performance improvement when database activity is sufficiently low.

However, there is a cost in recording this information in the database. In some circumstances the cost might be too high, particularly if you do not intend to use incremental backup operations.

The Scan_Optimization qualifier has different effects, depending on the type of backup operation you perform. In brief, you can enable or disable the scan optimization setting only when you issue a full offline backup command, and you can specify whether to use the data produced by a scan optimization only when you issue an incremental backup command. The following list describes this behavior in more detail:

- During an offline full backup operation, you can enable or disable the scan optimization setting.

Specify the Scan_Optimization qualifier to enable recording of the identities of areas that change after this backup operation completes.

Specify the Noscan_Optimization qualifier to disable recording of the identities of areas that change after this backup operation completes.

By default, the recording state remains unchanged (from the state it was in prior to execution of the Backup command) during a full backup operation.

1.10 RMU Backup Command

Note that specifying the `Scan_Optimization` or `Noscan_Optimization` qualifier with an offline full backup operation has no effect on the backup operation itself, it merely allows you to change the recording state for scan optimization.

- During an online full backup operation, the qualifier is ignored.
The recording state for scan optimization remains unchanged (from the state it was in prior to execution of the Backup command). If you execute an online full backup operation and specify the `Scan_Optimization` or `Noscan_Optimization` qualifier, RMU Backup returns an informational message to indicate that the qualifier is being ignored.
- During an incremental backup operation, the qualifier directs whether the scan optimization data (if recorded previously) will be used during the operation.

If you specify the `Scan_Optimization` qualifier, RMU Backup uses the optimization if Oracle Rdb has been recording the regions updated since the last full backup operation.

If you specify the `Noscan_Optimization` qualifier, RMU Backup does not use the optimization, regardless of whether Oracle Rdb has been recording the identity of the regions updated since the last full backup operation.

You cannot enable or disable the setting for scan optimizations during an incremental backup operation.

By default, the `Scan_Optimization` qualifier is used during incremental backup operations.

Tape_Expiration=date-time

Specifies the expiration date of the backup (.rbf) file. Note that when RMU Backup reads a tape, it looks at the expiration date in the file header of the first file on the tape and assumes the date it finds in that file header is the expiration date for the entire tape. Therefore, if you are backing up an .rbf file to tape, specifying the `Tape_Expiration` qualifier only has meaning if the .rbf is the first file on the tape. You can guarantee that the .rbf file will be the first file on the tape by specifying the `Rewind` qualifier and overwriting any existing files on the tape.

When the first file on the tape contains an expiration date in the file header, you cannot overwrite the tape before the expiration date unless you have the OpenVMS `SYSPRV` or `BYPASS` privilege.

Similarly, when you attempt to restore a .rbf file from tape, you cannot perform the restore operation after the expiration date recorded in the first file on the tape unless you have the OpenVMS `SYSPRV` or `BYPASS` privilege.

1.10 RMU Backup Command

By default, no expiration date is written to the .rbf file header. In this case, if the .rbf file is the first file on the tape, the tape can be overwritten immediately. If the .rbf file is not the first file on the tape, the ability to overwrite the tape is determined by the expiration date in the file header of the first file on the tape.

You cannot explicitly set a tape expiration date for an entire volume. The volume expiration date is always determined by the expiration date of the first file on the tape.

The `Tape_Expiration` qualifier cannot be used with a backup file written to disk.

See the *Oracle Rdb Guide to Database Maintenance* for information on tape label processing.

Usage Notes

- To use the RMU Backup command for a database, you must have the `RMU$BACKUP` privilege in the root file access control list (ACL) for the database or the OpenVMS `SYSPRV` or `BYPASS` privilege.
- If you attempt to back up an area with detected corruptions (or which has corrupt pages logged to the CPT), the backup operation fails immediately. If you attempt to back up an area that contains an undetected corruption (a corruption that has not been logged to the CPT), the backup operation proceeds until a corruption is found. These undetected corruptions are found only if you specify the `Checksum` qualifier with the Backup command.
- The following list provides usage information for parallel backup operations:
 - When performing a parallel backup operation, do not allocate or mount any tapes manually; this is done automatically by RMU Backup.
 - You can monitor the progress of a backup operation to tape on your Windows system using the Parallel Backup Monitor.
 - You can use the Parallel Backup Monitor to monitor the progress of a parallel backup operation to tape. Specify your backup operation using the `Parallel` qualifier with the `Executor_Count=1` option to approximate a non-parallel backup operation. Non-parallel backup operations (backup commands without the `Parallel` qualifier) cannot be monitored with the Parallel Backup Monitor.

1.10 RMU Backup Command

- If a parallel backup operation is issued from a server node, then RMU Backup communicates with SQL/Services to start the Coordinator. SQL/Services creates a Coordinator process.
- If a parallel backup operation is issued from a client node (for example, using RMUwin), then the same SQL/Services process that is created to execute client/server RMU Backup commands is used as the Coordinator process.
- You cannot use the Storage Library System (SLS) for OpenVMS with an RMU parallel backup.
- Logical area threshold information for storage areas with uniform page format is recorded in the backup file. See the *Oracle Rdb SQL Reference Manual* for more information on logical area threshold information.
- See the *Oracle Rdb Guide to Database Maintenance* for information on determining the working set requirements for a non-parallel backup operation.
- The following list provides usage information for the Quiet_Point and Noquiet_Point qualifiers
 - If the operation stalls when you attempt a quiet-point Oracle RMU backup operation, it may be because another user is holding the quiet-point lock. In some cases, there is no way to avoid this stall. In other cases you may find the stall is caused by a user who has previously issued and completed a read/write transaction, and is currently running a read-only transaction. When this user started the read/write transaction, the process acquired the quiet-point lock. Ordinarily, such a process retains this lock until it detaches from the database.

You can set the RDM\$BIND_SNAP_QUIET_POINT logical name to control whether or not such a process retains the quiet-point lock. Set the value of the logical name to “1” so that all transactions hold the quiet point lock until a backup process requests it. Read-only transactions will not obtain the quiet point lock; only read/write transactions will obtain the quiet point lock. Set the value of the logical name to “0” so that read-only transactions always release the quiet point lock at the beginning of the transaction, regardless of the existence of a backup process. All modified buffers in the buffer pool have to be written to disk before the transaction proceeds. Applications that utilize the fast commit feature and often switch between read-only and read/write transactions within a single attach may experience performance degradation if the logical is defined to “0”.

1.10 RMU Backup Command

Oracle recommends that you do not define the RDB\$BIND_SNAP_QUIET_POINT logical for most applications.

- If you intend to use the Noquiet_Point qualifier with a backup procedure that previously specified the Quiet_Point qualifier (or did not specify either the Quiet_Point or Noquiet_Point qualifier), you should examine any applications that execute concurrently with the backup operation. You might need to modify your applications or your backup procedure to handle the lock conflicts that might occur when you specify Noquiet_Point.

When you specify the Quiet_Point qualifier, the backup operation begins when a quiet point is reached. Other update transactions that are started after the database backup operation begins are prevented from executing until after the root file for the database has been backed up (the backup operation on the database storage areas begins after the root file is backed up).

- When devising your backup strategy for both the database and the after-image journal files, keep in mind the trade-offs between performing quiet-point backup operations and noquiet-point backup operations. A noquiet-point backup operation is quicker than a quiet-point backup operation, but usually results in a longer recovery operation. Because transactions can span .aij files when you perform noquiet-point .aij backup operations, you might have to apply numerous .aij files to recover the database. In a worst-case scenario, this could extend back to your last quiet-point .aij or database backup operation. If you rarely perform quiet-point backup operations, recovery time could be excessive.

One method you can use to balance these trade-offs is to perform regularly scheduled quiet-point .aij backup operations followed by noquiet-point database backup operations. (You could do the converse, but a quiet-point backup of the .aij file improves the performance of the recovery operation should such an operation become necessary.) Periodically performing a quiet-point .aij backup operation helps to ensure that your recovery time will not be excessive.

- Do not add new logical areas in the context of an exclusive transaction during an online backup operation.

When new logical areas are added during an online backup operation such that new records are physically placed in a location that the backup operation has not processed yet, Oracle Rdb returns the following error:

```
%RMU-F-CANTREADDBS, error reading pages !UL:!UL-!UL
```

1.10 RMU Backup Command

Logical areas that cause this problem are created when you do either of the following:

- Create a new table, start a transaction that reserves the new table in exclusive mode, and load the table with rows.
- Create a new table, start a transaction that reserves the new table in exclusive mode, and create an index for the table.

Creating new tables and populating them, or creating new indexes do not pose a problem if the table is not reserved in exclusive mode.

- If you back up a database without its root file ACL (using the `Noacl` qualifier of the RMU Backup command, for example), a user who wants to restore the database must have the OpenVMS `SYSPRV` or `BYPASS` privilege.
- You might receive the `RMU-I-WAITOFF` informational message when you try to back up your database if the database was manually opened with the RMU Open command and has not been manually closed with the RMU Close command. You also receive this message when you issue an RMU Close command with the `Nowait` qualifier and users are still attached to the database. To back up your database, you must have exclusive access to the database root file. This error message usually indicates that you do not have exclusive access to the database root file because the operating system still has access to it. If your database was manually opened with the RMU Open command, you should be able to gain exclusive access to the database root file by manually closing the database with an RMU Close command.

You can also receive this error message when you attempt other operations for which you must have exclusive access to the database root file. The solution in those cases is to attempt the operation again, later. Until you have exclusive access to the database root file, meaning that no other user gained access to the database between the time you issued the command and the time the command takes effect, you cannot complete those operations.

- Backup files are typically smaller in size than the actual database. They exclude free space and redundant structural information that can be reconstructed with a restore operation. However, backup files also contain some overhead to support the backup format. Compression factors range from approximately 1.2 to 3 depending on the organization and fullness of the database. The compression factor achieved for a given database is generally quite stable and usually only changes with structural or logical reorganization.

1.10 RMU Backup Command

Do not use the size of the backup file as an indication of the size of the database files. Use the RMU Analyze command to determine the actual data content.

- Backup performance is strongly affected by the job priority of the process running it. For best performance, a backup operation should execute at interactive priority, even when it is operating as a batch job.
- The following list contains information of interest if you are performing a backup operation to tape:

- If you back up the database to tape, and you do not specify the Parallel qualifier, you must mount the backup media by using the DCL MOUNT command before you issue the RMU Backup command. The tape must be mounted as a FOREIGN volume. Like the OpenVMS Backup utility (BACKUP), the RMU Backup command performs its own tape label processing. This does not prohibit backing up an Oracle Rdb database to an RMS file on a Files-11 disk.

When you specify the Parallel qualifier, you need not mount the backup media because the parallel executors allocate and mount the drive and labels for you.

- When RMU Backup creates a multivolume backup file, you can only append data to the end of the last volume. You cannot append data to the end of the first or any intermediate volumes.
- The RMU Backup command uses asynchronous I/O. Tape support provided includes support for multifile volumes, multivolume files, and multithreaded concurrent tape processing.
- If you allow RMU Backup to implicitly label tapes and you are using a tape drive that has a display (for example, a TA91 tape drive), the label displayed is the original label on the tape, not the label generated by RMU Backup.
- Oracle Corporation recommends that you supply a name for the backup file that is 17 or fewer characters in length. File names longer than 17 characters can be truncated. The system supports four file-header labels: HDR1, HDR2, HDR3, and HDR4. In HDR1 labels, the file identifier field contains the first 17 characters of the file name you supply. The remainder of the file name is written into the HDR4 label, provided that this label is allowed. If no HDR4 label is supported, a file name longer than 17 characters will be truncated.

1.10 RMU Backup Command

The following Oracle RMU commands are valid. The terminating period for the backup file name is not counted as a character, and the default file type of .rbf is assumed. Therefore, the system interprets the file name as wednesdays_backup, which is 17 characters in length:

```
$ RMU/BACKUP/REWIND/LABEL=TAPE MF_PERSONNEL MUA0:WEDNESDAYS_BACKUP.  
$ RMU/RESTORE/REWIND/LABEL=TAPE MUA0:WEDNESDAYS_BACKUP.
```

The following Oracle RMU commands create a backup file that cannot be restored. Because no terminating period is supplied, the system supplies a period and a file type of .rbf, and interprets the backup file name as wednesdays_backup.rbf, which is 20 characters in length. RMU truncates the backup file name to wednesdays_backup. When you attempt to restore the backed up file, RMU assumes the default extension of .rbf and returns an error when it cannot find the file wednesdays_backup.rbf on tape.

```
$ RMU/BACKUP/REWIND/LABEL=TAPE MF_PERSONNEL MUA0:WEDNESDAYS_BACKUP  
$ RMU/RESTORE/REWIND/LABEL=TAPE MUA0:WEDNESDAYS_BACKUP
```

- See the *Oracle Rdb Guide to Database Maintenance* for information on the steps RMU Backup follows in tape label checking for the RMU Backup command.
- The RMU Backup command works correctly with unlabeled or nonstandard formatted tapes when the Rewind qualifier is specified. However, tapes that have never been used or initialized, and nonstandard tapes sometimes produce errors that make OpenVMS mount attempts fail repeatedly. In this situation, RMU Backup cannot continue until you use the DCL INITIALIZE command to correct the error.
- Table 1–5 summarizes the tape labeling behavior of RMU Backup under a variety of circumstances. For example, the last row of the table describes what labels are applied when you specify both the Label=back qualifier and the Accept_Label qualifier and all the tapes (except the second) are already labeled and used in the following order: aaaa, no label, bbbb, dddd, cccc. The table shows that these tapes will be relabeled in the following order, with no operator notification occurring: aaaa, back02, bbbb, dddd, eeee. Table 1–5 assumes the backup file name is mf_personnel.rbf:

1.10 RMU Backup Command

Table 1–5 How Tapes are Relabeled During a Backup Operation

Qualifiers Specified	Current Labels	Resulting Labels	Operator Notification
Neither Label nor Accept_Label	mf_per mf_p05 mf_p06 mf_p02 mf_p03	mf_per mf_p05 mf_p06 mf_p02 mf_p03	None
Neither Label nor Accept_Label	aaaa no label bbbb dddd cccc	mf_per mf_p02 mf_p03 mf_p04 mf_p05	All tapes except second tape
Label=back	aaaa no label bbbb dddd cccc	back back02 back03 back04 back05	All tapes except second
Label=(back01, back02)	aaaa no label bbbb dddd cccc	back01 back02 back03 back04 back05	All tapes except second

(continued on next page)

1.10 RMU Backup Command

Table 1–5 (Cont.) How Tapes are Relabeled During a Backup Operation

Qualifiers Specified	Current Labels	Resulting Labels	Operator Notification
Accept_Label	aaaa no label bbbb dddd cccc	aaaa mf_p02 bbbb dddd cccc	None
Accept_Label, Label=back	aaaa no label bbbb dddd cccc	aaaa back02 bbbb dddd cccc	None

- When you use more than one tape drive for a backup operation, ensure that all of the tape drives are the same type (for example, all of the tape drives must be TA90s or TZ87s or TK50s). Using different tape drive types (for example, one TK50 and one TA90) for a single database backup operation may make database restoration difficult or impossible.

Oracle RMU attempts to prevent you from using different tape drive densities during a backup operation but is not able to detect all invalid cases and expects that all tape drives for a backup are of the same type.

As long as all of the tapes used during a backup operation can be read by the same type of tape drive during a restore operation, the backup is likely to be valid. This may be the case, for example, when you use a TA90 and a TA90E.

Oracle Corporation recommends that, on a regular basis, you test your backup and recovery procedures and environment using a test system. You should restore the database and then recover using after-image journals (AIJs) to simulate failure recovery of the production system.

Consult the *Oracle Rdb Guide to Database Maintenance* and the *Oracle Rdb Guide to Database Design and Definition* for additional information about Oracle Rdb backup and restore operations.

1.10 RMU Backup Command

- You should use the density values added in OpenVMS Version 7.2-1 for OpenVMS tape device drivers that accept them because previously supported values may not work as expected. If previously supported values are specified for drivers that support the OpenVMS Version 7.2-1 density values, the older values are translated to the Version 7.2-1 density values if possible. If the value cannot be translated, a warning message is generated, and the specified value is used.

If you use density values added in OpenVMS Version 7.2-1 for tape device drivers that do not support them, the values are translated to acceptable values if possible. If the value cannot be translated, a warning message is generated and the density value is translated to the existing default internal density value (MT\$K_DEFAULT).

One of the following density-related errors is generated if there is a mismatch between the specified density value and the values that the tape device driver accepts:

```
%RMU-E-DENSITY, TAPE_DEVICE:[000000]DATABASE.BCK; does not support specified density
```

```
%RMU-E-POSITERR, error positioning TAPE_DEVICE:
```

```
%RMU-E-BADDENSITY, The specified tape density is invalid for this device
```

- If you want to use an unsupported density value, use the VMS INITIALIZE and MOUNT commands to set the tape density. Do not use the Density qualifier.
- The density syntax used on the command can also be used in the plan file for the Parallel RMU backup to tape process.
- Oracle Rdb cannot continue a single .rda file across multiple disks. This means that, during a multidisk backup operation, each device must have enough free space to hold the largest storage area in the database. If the storage areas are on stripe sets and are larger than any actual single disk, then the devices specified for the backup file must be striped also.

It is not possible to indicate which storage area should be backed up to a given device.

- Because data stream names representing the database are generated based on the backup file name specified for the Oracle RMU backup command, you must either use a different backup file name to store the next backup of the database to the Librarian utility or first delete the existing data streams generated from the backup file name before the same backup file name can be reused.

1.10 RMU Backup Command

To delete the existing data streams stored in the Librarian utility, you can use a Librarian management utility or the Oracle RMU Librarian/Remove command.

- If you are backing up to multiple disk devices using thread pools, the following algorithm to assign threads is used by the backup operation:
 - The size of each area is calculated as the product of the page length in bytes multiplied by the highest page number used (maximum page number) for that area.
 - The area sizes are sorted by descending size and ascending device name. For internal processing reasons, the system area is placed as the first area in the first thread.
 - Each of the remaining areas is added to the thread that has the lowest byte count.

The same algorithm is used for tape devices, but the areas are partitioned among writer threads, not disk devices.

- The partitioning for backup to multiple disk devices is done by disk device, not by output thread, because there will typically be more disk devices than output threads, and an area cannot span a device.

Examples

Example 1

The following command performs a full backup operation on the `mf_personnel` database and displays a log of the session:

```
$ RMU/BACKUP MF_PERSONNEL -  
_$_ DISK2[USER1]MF_PERS_FULL_BU.RBF /LOG
```

Example 2

To perform an incremental backup operation, include the Incremental qualifier. Assume a full backup operation was done late Monday night. The following command performs an incremental backup operation on the database updates only for the following day:

```
$ RMU/BACKUP/INCREMENTAL MF_PERSONNEL.RDB -  
_$_ $222$DUA20:[BCK]TUESDAY_PERS_BKUP/LOG
```

Example 3

1.10 RMU Backup Command

To back up the database while there are active users, specify the Online qualifier:

```
$ RMU/BACKUP/ONLINE MF_PERSONNEL.RDB -
_ $ $222$DUA20:[BACKUPS]PERS_BU.RBF /LOG
```

Example 4

The following RMU Backup command includes only the EMPIDS_LOW and EMPIDS_MID storage areas in the backup file of the mf_personnel database. All the other storage areas in the mf_personnel database are excluded from the backup file:

```
$ RMU/BACKUP/INCLUDE=(EMPIDS_LOW,EMPIDS_MID) -
_ $ MF_PERSONNEL.RDB $222$DUA20:[BACKUPS]MF_PERS_BU.RBF
```

Example 5

The following command backs up the mf_personnel database but not the root file ACL for the database:

```
$ RMU/BACKUP/NOACL MF_PERSONNEL MF_PERS_NOACL
```

Example 6

The following command backs up the mf_personnel database without waiting for a quiet point in the database:

```
$ RMU/BACKUP/NOQUIET_POINT MF_PERSONNEL MF_PERS_NQP
```

Example 7

The following command creates a journal file, pers_journal.jnl, and a backup file, pers_backup.rbf.

```
$ RMU/BACKUP/JOURNAL=PERS_JOURNAL MF_PERSONNEL PERS_BACKUP
```

Example 8

The following example backs up all the storage areas in the mf_personnel database except for the read-only storage areas.

```
$ RMU/BACKUP/NO_READ_ONLY MF_PERSONNEL MF_PERSONNEL_BU
```

Example 9

The following example assumes that you are using multiple tape drives to do a large backup operation. By specifying the Loader_Synchronization qualifier, this command does not require you to load tapes as each becomes full. Instead, you can load tapes on a loader or stacker and RMU Backup will wait until all concurrent tape operations have concluded for one set of tape volumes before assigning the next set of tape volumes.

1.10 RMU Backup Command

Using this example, you:

1. Verify the database.
2. Allocate each tape drive.
3. Manually place tapes BACK01 and BACK05 on the \$111\$MUA0: drive.
4. Manually place tapes BACK02 and BACK06 on the \$222\$MUA1: drive.
5. Manually place tapes BACK03 and BACK07 on the \$333\$MUA2: drive.
6. Manually place tapes BACK04 and BACK08 on the \$444\$MUA3: drive.
7. Mount the first volume.
8. Perform the backup operation.
9. Dismount the last tape mounted. (This example assumes it is on the \$444\$MUA3: drive.)
10. Deallocate each tape drive.

```
$ RMU/VERIFY DB_DISK:[DATABASE]MF_PERSONNEL.RDB
$
$ ALLOCATE $111$MUA0:
$ ALLOCATE $222$MUA1:
$ ALLOCATE $333$MUA2:
$ ALLOCATE $444$MUA3:
$
$ MOUNT/FOREIGN $111$MUA0:
$
$ RMU/BACKUP /LOG/REWIND/LOADER_SYNCHRONIZATION -
_ $ /LABEL=(BACK01, BACK02, BACK03, BACK04, BACK05, -
_ $ BACK06, BACK07, BACK08) -
_ $ DB_DISK:[MFPERS]MF_PERSONNEL.RDB -
_ $ $111$MUA0:PERS_FULL_MAR30.RBF/Master, $222$MUA1: -
_ $ $333$MUA1:/MASTER, $444$MUA3
$
$ DISMOUNT $444$MUA3:
$
$ DEALLOCATE $111$MUA0:
$ DEALLOCATE $222$MUA1:
$ DEALLOCATE $333$MUA2:
$ DEALLOCATE $444$MUA4:
```

Example 10

The following example generates a parallel backup plan file, but does not execute it. The result is a backup plan file. See the next example for a description of the plan file.

1.10 RMU Backup Command

```
$ RMU/BACKUP/PARALLEL=(EXEC=4, NODE=(NODE1, NODE2)) -
_ $ /LIST_PLAN=(PARTIAL.PLAN)/NOEXECUTE/INCLUDE=(RDB$SYSTEM, EMPIDS_LOW, -
_ $ EMPIDS_MID, EMPIDS_OVER, SALARY_HISTORY, EMP_INFO) -
_ $ /LABEL=(001, 002, 003, 004, 005, 006, 007, 008, 009) -
_ $ /CHECKSUM_VERIFICATION -
_ $ MF_PERSONNEL TAPE1:MF_PARTIAL.RBF, TAPE2:, TAPE3:, TAPE4:
```

Example 11

The following display shows the contents of the plan file, `PARTIAL.PLAN` created in the preceding example. The following callouts are keyed to this display:

- 1 The Plan Parameters include all the parameters specified on the RMU BACKUP command line and all possible command qualifiers.
- 2 Command qualifiers that are not specified on the command line are represented as comments in the plan file. This allows you to edit and adjust the plan file for future use.
- 3 Command qualifiers that are explicitly specified on the command line are represented in the plan file as specified.
- 4 Executor parameters are listed for each executor involved in the backup operation.

```
! Plan created on 28-JUN-1996 by RMU/BACKUP.
```

```
Plan Name = PARTIAL
Plan Type = BACKUP
```

```
Plan Parameters: 1
```

```
Database Root File = DISK1:[DB]MF_PERSONNEL;1
Backup File = PARTIAL.RBF
! Journal = specification for journal file 2
! Tape_Expiration = dd-mmm-yyyy
! Active_IO = number of buffers for each tape
! Protection = file system protection for backup file
! Block_Size = bytes per tape block
! Density = tape density
![No]Group_Size = number of blocks between XOR blocks
! Lock_Timeout = number of second to wait for locks
! Owner = identifier of owner of the backup file
! Page_Buffers = number of buffers to use for each storage area
Checksum_Verification 3
CRC = AUTODIN_II
```

1.10 RMU Backup Command

```
NoIncremental
! Accept_labels preserves all tape labels
Log
! Loader_synchronization labels tapes in order across drives
! Media_loader forces support of a tape media loader
NoOnline
Quiet_Point
NoRewind
Statistics
ACL
![No]Scan_Optimization
Labels = ( -
          001      -
          002      -
          003      -
          004      -
          005      -
          006      -
          007      -
          008      -
          009      )
End Plan Parameters
Executor Parameters :
  Executor Name = COORDINATOR
  Executor Type = Coordinator
End Executor Parameters
Executor Parameters : 4
  Executor Name = WORKER_001
  Executor Type = Worker
  Executor Node = NODE1
  Start Storage Area List
    EMPIDS_LOW,
    SALARY_HISTORY
  End Storage Area List
  Tape Drive List
    Tape Drive = TAPE1:
    MASTER
  End Tape Drive List
End Executor Parameters
Executor Parameters :
  Executor Name = WORKER_002
  Executor Type = Worker
  Executor Node = NODE2
  Start Storage Area List
    EMPIDS_MID,
    RDB$SYSTEM
  End Storage Area List
  Tape Drive List
    Tape Drive = TAPE2:
    MASTER
  End Tape Drive List
End Executor Parameters
```

1.10 RMU Backup Command

```
Executor Parameters :
  Executor Name = WORKER_003
  Executor Type = Worker
  Executor Node = NODE1
  Start Storage Area List
    EMPIDS_OVER
  End Storage Area List
  Tape Drive List
    Tape Drive = TAPE3
    MASTER
  End Tape Drive List
End Executor Parameters
Executor Parameters :
  Executor Name = WORKER_004
  Executor Type = Worker
  Executor Node = NODE2
  Start Storage Area List
    EMP_INFO
  End Storage Area List
  Tape Drive List
    Tape Drive = TAPE4
    MASTER
  End Tape Drive List
End Executor Parameters
```

Example 12

The following example demonstrates the use of the `Restore_Options` qualifier. The first command backs up selected areas of the `mf_personnel` database and creates an options file. The second command shows the contents of the options file. The last command demonstrates the use of the options file with the RMU Restore command.

```
$ RMU/BACKUP MF_PERSONNEL.RDB MF_EMPIDS.RBF/INCLUDE=(EMPIDS_LOW, -
_ $ EMPIDS_MID, EMPIDS_OVER) /RESTORE_OPTIONS=MF_EMPIDS.OPT
%RMU-I-NOTALLARE, Not all areas will be included in this backup file
$ !
$ !
$ TYPE MF_EMPIDS.OPT
! Options file for database USER1:[MFDB]MF_PERSONNEL.RDB;1
! Created 18-JUL-1995 10:31:08.82
! Created by BACKUP command

EMPIDS_LOW -
  /file=USER2:[STOA]EMPIDS_LOW.RDA;1 -
  /blocks_per_page=2 -
  /extension=ENABLED -
  /read_write -
  /spams -
  /thresholds=(70,85,95) -
  /snapshot=(allocation=100, -
    file=USER2:[SNP]EMPIDS_LOW.SNP;1)
```

1.10 RMU Backup Command

```
EMPIDS_MID -
  /file=USER3:[STOA]EMPIDS_MID.RDA;1 -
  /blocks_per_page=2 -
  /extension=ENABLED -
  /read_write -
  /spams -
  /thresholds=(70,85,95) -
  /snapshot=(allocation=100, -
    file=USER3:[SNP]EMPIDS_MID.SNP;1)

EMPIDS_OVER -
  /file=USER4:[STOA]EMPIDS_OVER.RDA;1 -
  /blocks_per_page=2 -
  /extension=ENABLED -
  /read_write -
  /spams -
  /thresholds=(70,85,95) -
  /snapshot=(allocation=100, -
    file=USER4:[SNP]EMPIDS_OVER.SNP;1)

$ !
$ !
$ !
$ RMU/RESTORE MF_EMPIDS.RBF /AREA/OPTIONS=MF_EMPIDS.OPT
```

Example 13

The following example uses a density value with compression:

```
$RMU/BACKUP/DENSITY=(TK89,COMPACTION)/REWIND/LABEL=(LABEL1,LABEL2) -
_ $ MF_PERSONNEL TAPE1:MFP.BCK, TAPE2:
```

Example 14

The following example shows how to perform a multidisk backup operation.

```
$ RMU/BACKUP/DISK MF_PERSONNEL DEVICE1:[DIRECTORY1]MFP.RBF, -
_ $ DEVICE2:[DIRECTORY2]
.
.
.
%RMU-I-COMPLETED, BACKUP operation completed at 1-MAY-2001 17:40:53.81
```

Example 15

The following example shows the use of the Librarian qualifier with a plan file.

```
$RMU/BACKUP/PARALLEL=EXECUTOR=3/LIBRARIAN=WRITER_THREADS=3 -
_ $ /LIST_PLAN=FILENAME.PLAN/NOEXECUTE/LOG DATABASE FILENAM.RBF
$RMU/BACKUP/PLAN FILENAME.PLAN
$RMU/RESTORE/LIBRARIAN=(READER_THREADS=9)/LOG FILENAME.RBF
```

1.10 RMU Backup Command

The first backup command creates the plan file for a parallel backup, but does not execute it. The second backup command executes the parallel backup using the plan file. Three worker processes are used; each process uses the three writer threads specified with the Librarian qualifier. Each writer thread in each process writes one stream of backup data to the Librarian utility; a total of nine streams is written.

1.11 RMU Backup After_Journal Command

1.11 RMU Backup After_Journal Command

Creates a backup file of the database after-image journal (.aij) file or files.

Oracle Rdb supports two types of after-image journaling mechanisms: one that employs a single, extensible .aij file and another that employs multiple, fixed-size .aij files. The type of journaling mechanism being used at the time the backup operation starts can affect how you should specify the backup command. Further information on how these two journaling mechanisms affect the backup operation appears in the Description section.

The backup .aij file is an actual, usable .aij file that can be applied to the appropriate Oracle Rdb database in a recovery operation.

The RMU Backup After_Journal command can be used while users are attached to the database.

Format

```
RMU/Backup/After_Journal root-file-spec {backup-file-spec | ""}
```

Command Qualifiers

```
/[No]Accept_Label  
/Active_IO=max-writes  
/Block_Size=integer  
/[No]Continuous=(n)  
/[No]Crc  
/Crc[=Autodin_II]  
/Crc=Checksum  
/Density=(density-value, [No]Compaction)  
/[No]Edit_Filename=(options)  
/Encrypt={({Value=|Name=}|,Algorithm=})  
/Format={Old_File|New_Tape}  
/[No]Group_Size[=interval]  
/[No]Interval=number-seconds  
/Label=(label-name-list)  
/Librarian[=options]  
/Lock_Timeout=seconds  
/[No]Log  
/[No]Media_Loader
```

Defaults

```
/Accept_Label  
/Active_IO=3  
See description  
/Nocontinuous  
See description  
See description  
See description  
See description  
/Noedit_Filename  
See description  
/Format=Old_File  
See description  
/Nointerval  
See description  
None  
See description  
Current DCL verify value  
See description
```

1.11 RMU Backup After_Journal Command

<code>/Owner=user-id</code>	See description
<code>/Prompt={Automatic Operator Client}</code>	See description
<code>/Protection=openvms-file-protection</code>	See description
<code>/[No]Quiet_Point</code>	<code>/Quiet_Point</code>
<code>/[No]Rename</code>	<code>/Norename</code>
<code>/[No]Rewind</code>	<code>/Norewind</code>
<code>/[No]Sequence=(n,m)</code>	<code>/Nosequence</code>
<code>/Tape_Expiration=date-time</code>	The current time
<code>/[No]Threshold=disk-blocks</code>	<code>/Nothreshold</code>
<code>/Until=time</code>	See description
<code>/[No]Wait=n</code>	See description

Description

The backup .aij file you create can be used with the RMU Recover command to recover (roll forward) journaled transactions. In some cases, you might have to issue additional Recover commands: one for the backup .aij file and a second for the more recent .aij files.

Oracle Rdb supports the following two types of .aij file configurations:

- A configuration that uses a single, extensible .aij file
This is the method always used prior to Version 6.0 and is also the default (for compatibility with versions of Oracle Rdb prior to Version 6.0).
When an extensible .aij file is used, one .aij file is written to and extended, as needed, by the number of blocks specified when the .aij file was created. The .aij file continues to be extended until it is backed up (or the device on which it resides is full).
The RMU Backup After_Journal command copies transactions recorded in the current .aij file (always on a disk device) to the backup .aij file (which might be on a tape or disk device). On completion, the current .aij file is truncated and used again. During periods of high update activity, the truncation of the active .aij file might not be performed because of conflicting access to the .aij file by other users, but the storage allocated to the active .aij file is still used again when the backup operation completes.
- A configuration that uses two or more fixed-size .aij files
When fixed-size .aij files are used, the database maintains multiple .aij files; however, only one .aij file is written to at a time. This .aij file is considered the *current* journal. When this .aij file is filled, a switchover occurs to allow journaling to continue in another available .aij file.

1.11 RMU Backup After_Journal Command

The RMU Backup After_Journal command works as follows with fixed-size .aij files:

- Backs up any full .aij files
The backup operation first backs up the .aij file with the lowest AIJ sequence number (that needs backing up), the operation continues to back up .aij files in ascending AIJ sequence number. If a lot of .aij files need to be backed up when the RMU Backup After_Journal command is issued, one backup file might contain the contents of all the .aij files being backed up.
- Backs up the current .aij file
Even if there are active transactions at the time of the backup operation, the RMU Backup After_Journal command will start to backup the current active .aij file. If you have specified the Quiet_Point qualifier, the backup operation stalls at some point waiting for all the current transactions to complete.
- Switches to the next available .aij file
An **available** .aij file is one for which both of the following are true:
 - * It is not currently being used to record transactions.
 - * It is not needed for a redo operation.Such an .aij file might be one that has never been used, or one that has already been backed up.

Once a specified .aij file has been completely backed up, it is initialized and marked as available for reuse.

Note

The method employed, fixed-size .aij files or an extensible .aij file, cannot be set explicitly by the user. Any event that reduces the number of .aij files to one results in an extensible .aij file being used. Any event that increases the number .aij files to two or more results in fixed-size .aij files being used. An inaccessible .aij file is counted in these equations. Therefore, if you have one accessible .aij file and one inaccessible .aij file (perhaps because it has been suppressed), fixed-size .aij journaling is still used.

Because some of the RMU Backup After_Journal qualifiers are valid only when one or the other journaling mechanism is employed, you might need to issue an RMU Dump command to determine which journaling mechanism is currently being employed before you issue an RMU Backup After_Journal command.

1.11 RMU Backup After_Journal Command

Also note that once a backup operation begins, .ajj file modification is not allowed until the backup operation is complete. However, if the type of journaling changes between the time you issue an RMU Dump command and the time you issue the RMU Backup After_Journal command, you receive an error message if you have specified qualifiers that are only valid with a particular type of journaling mechanism. (The Threshold qualifier, for example, is valid only when the extensible journaling mechanism is being used.)

If you back up the .ajj file or files to tape, you must mount the backup media by using the DCL MOUNT command before you issue the RMU Backup After_Journal command. If you specify the default, Format=Old_File, the RMU Backup After_Journal command uses RMS to write to the tape and the tape must be mounted as an OpenVMS volume. (That is, do not specify the FOREIGN qualifier with the MOUNT command.) If you specify the Format=New_Tape qualifier, the RMU Backup After_Journal command writes backup files in a format similar to that used by the RMU Backup command, and you must mount the tape as a FOREIGN volume.

If you back up an .ajj file to disk, you can then use the OpenVMS Backup utility (BACKUP) to archive the .ajj backup file.

The RMU Backup After_Journal command can be used in a batch job to avoid occupying an interactive terminal for long periods of time. The Continuous, Interval, Threshold, and Until qualifiers control the duration and frequency of the backup process. When you use the Continuous qualifier, the command can occupy a terminal indefinitely. Therefore, it is good practice to issue the command through a batch process when executing a continuous .ajj file backup operation. However, remember that the portion of the command procedure that follows the RMU Backup After_Journal command is not executed until after the time specified by the Until qualifier.

When the RMU Backup After_Journal command completes, it records information about the state of the backup files in the global process symbols presented in the following list. You can use these symbols in DCL command procedures to help automate the backup operation.

These symbols are not set, however, if you have issued a DCL SET SYMBOL /SCOPE=(NOLOCAL, NOGLOBAL) command.

- RDM\$AIJ_SEQNO

1.11 RMU Backup After_Journal Command

Contains the sequence number of the last .aij backup file written to tape. This symbol has a value identical to RDM\$AIJ_BACKUP_SEQNO. RDM\$AIJ_SEQNO was created prior to Oracle Rdb Version 6.0 and is maintained for compatibility with earlier versions of Oracle Rdb.

- **RDM\$AIJ_CURRENT_SEQNO**
Contains the sequence number of the currently active .aij file. A value of -1 indicates that after-image journaling is disabled.
- **RDM\$AIJ_NEXT_SEQNO**
Contains the sequence number of the next .aij file that needs to be backed up. This symbol always contains a positive integer value (which can be 0).
- **RDM\$AIJ_LAST_SEQNO**
Contains the sequence number of the last .aij file ready for a backup operation, which is different from the current sequence number if fixed-size journaling is being used. A value of -1 indicates that no journal has ever been backed up.
If the value of the RDM\$AIJ_NEXT_SEQNO symbol is greater than the value of the RDM\$AIJ_LAST_SEQNO symbol, no more .aij files are currently available for the backup operation.
- **RDM\$AIJ_BACKUP_SEQNO**
Contains the sequence number of the last .aij file backed up by the backup operation. This symbol is set at the completion of an .aij backup operation. A value of -1 indicates that this process has not yet backed up an .aij file.
The RMU Backup After_Journal command provides an informational message that describes the exact sequence number for each .aij backup file operation.
- **RDM\$AIJ_COUNT**
Contains the number of available .aij files.
- **RDM\$AIJ_ENDOFFILE**
Contains the end of file block number for the current AIJ journal.
- **RDM\$AIJ_FULLNESS**
Contains the percent fullness of the current AIJ journal.

Note that these are string symbols, not integer symbols, even though their equivalence values are numbers. Therefore performing arithmetic operations with them produces unexpected results.

1.11 RMU Backup After_Journal Command

If you need to perform arithmetic operations with these symbols, first convert the string symbol values to numeric symbol values using the OpenVMS F\$INTEGER lexical function. For example:

```
$ SEQNO_RANGE = F$INTEGER(RDB$AIJ_LAST_SEQNO)
                - F$INTEGER(RDB$AIJ_NEXT_SEQNO)
```

Command Parameters

root-file-spec

The name of the database root file. The root file name is also the name of the database. An error results if you specify a database that does not have after-image journaling enabled. The default file extension is .rdb.

backup-file-spec

A file specification for the .aij backup file. The default file extension is .aij unless you specify the Format=New_Tape qualifier. In this case, the default file extension is .aij_rbf.

""

Double quotes indicate to Oracle RMU that you want the default .aij backup file specification to be used. The default .aij backup file specification is defined with the SQL ALTER DATABASE statement or the RMU Set After_Journal command.

Command Qualifiers

Accept_Label

Specifies that Oracle RMU should keep the current tape label it finds on a tape during a backup operation even if that label does not match the default label or that specified with the Label qualifier. Operator notification does not occur unless the tape's protection, owner, or expiration date prohibit writing to the tape. However, a message is logged (assuming logging is enabled) and written to the backup journal file (assuming you have specified the Journal qualifier) to indicate that a label is being preserved and which drive currently holds that tape.

This qualifier is particularly useful when your backup operation employs numerous previously used (and thus labeled) tapes and you want to preserve the labels currently on the tapes.

If you do not specify this qualifier, the default behavior of Oracle RMU is to notify the operator each time it finds a mismatch between the current label on the tape and the default label (or the label you specify with the Label qualifier).

1.11 RMU Backup After_Journal Command

See the description of the Labels qualifier in this section for information on default labels. See Table 1–5 for a summary of which labels are applied under a variety of circumstances.

Active_IO=max-writes

Specifies the maximum number of write operations to a backup device that the RMU Backup After_Journal command attempts simultaneously. This is not the maximum number of write operations in progress; that value is the product of active system I/O operations and the number of devices being written to simultaneously.

The value of the Active_IO qualifier can range from 1 to 5. The default value is 3. Values larger than 3 can improve performance with some tape drives.

Block_Size=integer

Specifies the maximum record size for the backup file. The size can vary between 2048 and 65,024 bytes. The default value is device dependent. The appropriate block size is a compromise between tape capacity and error rate.

Continuous=(n)

Nocontinuous

Specifies whether the .aj backup process operates continuously. You specify termination conditions by specifying one or both of the following:

- The Until qualifier
Specifies the time and date to stop the continuous backup process.
- The value for *n*
Specifies the number of iterations Oracle RMU should make through the set of active .aj files before terminating the backup operation.

When you use the Continuous qualifier, you must use either the Until or the Interval qualifier or provide a value for *n* (or both) to specify when the backup process should stop. You can also stop the backup process by using the DCL STOP command when backing up to disk.

If you specify the Continuous qualifier, Oracle Rdb does not terminate the backup process after truncating the current .aj file (when an extensible journal is used) or after switching to a new journal (when fixed-size journals are used). Instead, the backup process waits for the period of time that you specify in the argument to the Interval qualifier. After that time interval, the backup process tests to determine if the threshold has been reached (for an extensible journal) or if the journal is full (for fixed-size journals). It then performs backup operations as needed and then waits again until the next interval

1.11 RMU Backup After_Journal Command

break, unless the number of iterations or the condition specified with the Until qualifier has been reached.

If you specify the Continuous qualifier, the backup process occupies the terminal (that is, no system prompt occurs) until the process terminates. Therefore, you should usually enter the command through a batch process.

If you specify the default, the Nocontinuous qualifier, the backup process stops as soon as it completely backs up the .aij file or files. The default value for the number of iterations (*n*) is 1.

If you specify both the Until qualifier and the Continuous=*n* qualifier, the backup operation stops after whichever completes first. If you specify the Until=12:00 qualifier and the Continuous=5 qualifier, the backup operation terminates at 12:00 even if only four iterations have completed. Likewise, if five iterations are completed prior to 12:00, the backup operation terminates after the five iterations are completed.

The Continuous qualifier is not recommended when you are backing up to tape, particularly when the Format=New_Tape qualifier is used. If your tape operations complete successfully, you do not want the backup operation to continue in an infinite loop.

Using the DCL STOP command to terminate a backup operation to tape might result in an incomplete or corrupt backup file. However, do not delete this backup file; it is extremely important that you preserve *all* .aij backup files, even those produced by failed or terminated backup processes. If the resultant .aij backup file is discarded, the next .aij backup file could contain a “gap” in transactions, so that no transactions would ever be rolled forward from that point on.

Crc[=Autodin_II]

Uses the AUTODIN-II polynomial for the 32-bit CRC calculation and provides the most reliable end-to-end error detection. This is the default for NRZ/PE (800/1600 bits/inch) tape drives.

Typing Crc is sufficient to select the Crc=Autodin_II qualifier. It is not necessary to type the entire qualifier.

Crc=Checksum

Uses one's complement addition, which is the same computation used to do a checksum of the database pages on disk. This is the default for GCR (6250 bits/inch) tape drives and for TA78, TA79, and TA81 tape drives.

The Crc=Checksum qualifier allows detection of errors.

1.11 RMU Backup After_Journal Command

Nocrc

Disables end-to-end error detection. This is the default for TA90 (IBM 3480 class) drives.

Note

The overall effect of the `Crc=Autodin_II`, `Crc=Checksum`, and `Nocrc` qualifier defaults is to improve tape reliability so that it is equal to that of a disk. If you retain your tapes longer than 1 year, the `Nocrc` default might not be adequate. For tapes retained longer than 1 year, use the `Crc=Checksum` qualifier.

If you retain your tapes longer than 3 years, you should always use the `Crc=Autodin_II` qualifier.

Tapes retained longer than 5 years could be deteriorating and should be copied to fresh media.

See the *Oracle Rdb Guide to Database Maintenance* for details on using the `Crc` qualifiers to avoid underrun errors.

Density=(density-value,[No]Compaction)

Specifies the density at which the output volume is to be written. The default value is the format of the first volume (the first tape you mount). You do not need to specify this qualifier unless your tape drives support data compression or more than one recording density.

The `Density` qualifier is applicable only to tape drives. Oracle RMU returns an error message if this qualifier is used and the target device is not a tape drive.

If your systems are running OpenVMS versions prior to 7.2-1, specify the `Density` qualifier as follows:

- For TA90E, TA91, and TA92 tape drives, specify the number in bits per inch as follows:
 - `Density = 70000` to initialize and write tapes in the compacted format.
 - `Density = 39872` or `Density = 40000` for the noncompacted format.
- For SCSI (Small Computer System Interface) tape drives, specify `Density = 1` to initialize and write tapes using the drive's hardware data compression scheme.
- For other types of tape drives, you can specify a supported `Density` value between 800 and 160000 bits per inch.

1.11 RMU Backup After_Journal Command

- For all tape drives, specify Density = 0 to initialize and write tapes at the drive's standard density.

Do not use the `Compaction` or `NoCompaction` keyword for systems running OpenVMS versions prior to 7.2-1. On these systems, compression is determined by the density value and cannot be specified.

Oracle RMU supports the OpenVMS tape density and compression values introduced in OpenVMS Version 7.2-1. The following table lists the added density values supported by Oracle RMU.

DEFAULT	800	833	1600
6250	3480	3490E	TK50
TK70	TK85	TK86	TK87
TK88	TK89	QIC	8200
8500	8900	DLT8000	
SDLT	SDLT320		
DDS1	DDS2	DDS3	DDS4
AIT1	AIT2	AIT3	AIT4
COMPACTION	NOCOMPACTION		

If the OpenVMS Version 7.2-1 density values and the previous density values are the same (for example, 800, 833, 1600, 6250), the specified value is interpreted as an OpenVMS Version 7.2-1 value if the tape device driver accepts them, and as a previous value if the tape device driver accepts previous values only.

For the OpenVMS Version 7.2-1 values that accept tape compression you can use the following syntax:

```
/DENSITY = (new_density_value, [No]Compaction)
```

In order to use the `Compaction` or `NoCompaction` keyword, you must use one of the following density values that accepts compression:

DEFAULT	3480	3490E	8200
8500	8900	TK87	TK88
TK89	DLT8000	SDLT	SDLT320
AIT1	AIT2	AIT3	AIT4
DDS1	DDS2	DDS3	DDS4

Refer to the OpenVMS documentation for more information about density values.

1.11 RMU Backup After_Journal Command

Edit_Filename=(options)

Noedit_Filename

When the Edit_Filename=(options) qualifier is used, the specified backup file name is edited by appending any or all of the values specified by the following options to the backup file name:

- **Day_Of_Week**
The current day of the week expressed as a 1-digit integer (1 to 7). Sunday is expressed as 1; Saturday is expressed as 7.
- **Day_Of_Year**
The current day of the year expressed as a 3-digit integer (001 to 366).
- **Hour**
The current hour of the day expressed as a 2-digit integer (00 to 23).
- **Julian_Date**
The number of days passed since 17-Nov-1858.
- **Minute**
The current minute of the hour expressed as a 2-digit integer (00 to 59).
- **Month**
The current month expressed as a 2-digit integer (01 to 12).
- **Sequence**
The journal sequence number of the first journal in the backup operation.
- **Vno**
Synonymous with the Sequence option. See the description of the Sequence option.
- **Year**
The current year (A.D.) expressed as a 4-digit integer.

If you specify more than one option, place a comma between each option.

The edit is performed in the order specified. For example, the file backup.aij and the qualifier /EDIT_FILENAME=(HOUR, MINUTE, MONTH, DAY_OF_MONTH, SEQUENCE) creates a file with the name backup_160504233.aij when journal 3 is backed up at 4:05 P.M. on April 23rd.

1.11 RMU Backup After_Journal Command

You can make the name more readable by inserting quoted strings between each `Edit_Filename` option. For example, the following qualifier adds the string "\$30_0155-2" to the .aij file name if the day of the month is the 30th, the time is 1:55 and the version number is 2:

```
/EDIT_FILENAME=( "$ " , DAY_OF_MONTH, " _ " , HOUR, MINUTE, "- " , SEQUENCE)
```

This qualifier is useful for creating meaningful file names for your backup files and makes file management easier.

The default is the `Noedit_Filename` qualifier.

Encrypt={Value= | Name=}[,Algorithm=]

The `Encrypt` qualifier encrypts the backup file of the after image journal.

Specify a key value as a string or, the name of a predefined key. If no algorithm name is specified the default is `DESCBC`. For details on the `Value`, `Name` and `Algorithm` parameters see `HELP ENCRYPT`.

This feature requires the OpenVMS `Encrypt` product to be installed and licensed on this system.

This feature only works for a newer format backup file which has been created using `/FORMAT=NEW_TAPE`. Therefore you have to specify `/FORMAT=NEW_TAPE` with this command if you also use `/ENCRYPT`.

Format=Old_Rms

Format=New_Tape

Synonymous with `Format=Old_File` and `Format=New_Tape` qualifiers. See the description of those qualifiers.

Format=Old_File

Format=New_Tape

Specifies the format in which the backup file is to be written. Oracle Corporation recommends that you specify the `Format=Old_File` qualifier (or accept the default) when you back up your .aij file to disk and that you specify the `Format=New_Tape` qualifier when you back up your .aij file to tape.

If you specify the default, the `Format=Old_File` qualifier, the RMU Backup command writes the file in a format that is optimized for a file structured disk. If you specify the `Format=New_Tape` qualifier, the Oracle RMU command writes the file in a format that is optimized for tape storage, including ANSI/ISO labeling and end-to-end error detection and correction. When you specify the `Format=New_Tape` qualifier and back up the .aij file to tape, you must mount the backup media by using the `DCL MOUNT` command

1.11 RMU Backup After_Journal Command

before you issue the RMU Backup After_Journal command. The tape must be mounted as a FOREIGN volume. If you mount the tape as an OpenVMS volume (that is, you do not mount it as a FOREIGN volume) and you specify the Format=New_Tape qualifier, you receive an RMU-F-MOUNTFOR error.

When you back up your .aij file to tape and specify the Format=New_Tape qualifier you can create a backup copy of the database (using the RMU Backup command) and a backup of the .aij file (using the RMU Backup After_Journal command) without dismounting your tape.

The following tape qualifiers have meaning only when used in conjunction with the Format=New_Tape qualifier:

- Active_IO
- Block_Size
- Crc
- Density
- Group_Size
- Label
- Owner
- Protection
- Rewind
- Tape_Expiration

The Format=New_Tape and the Noquiet_Point qualifiers cannot be used on the same Oracle RMU command line. See the Usage Notes section for an explanation.

The default file specification, when you specify the Format=New_Tape qualifier is .aij_rbf. The default file specification, when you specify the Format=Old_File qualifier is .aij.

Although Oracle Corporation recommends that you specify the Format=New_Tape qualifier for .aij backup operations to tape and the Format=Old_File qualifier for .aij backup operations to disk, Oracle RMU does not enforce this recommendation. This is to provide compatibility with prior versions of Oracle Rdb. See the Usage Notes section for issues and problems you can encounter when you do not follow this recommendation.

Group_Size[=interval]

Nogroup_Size

Specifies the frequency at which XOR recovery blocks are written to tape. The group size can vary from 0 to 100. Specifying a group size of zero or specifying the Nogroup_Size qualifier results in no XOR recovery blocks being written. The Group_Size qualifier is only applicable to tape, and its default value is

1.11 RMU Backup After_Journal Command

device dependent. Oracle RMU returns an error message if this qualifier is used and the target device is not a tape device.

Interval=number-seconds

Nointerval

Specifies the number of seconds for which the backup process waits. Use this qualifier in conjunction with the Continuous qualifier and the extensible journaling method. The interval determines how often to test the active .aj file to determine if it contains more blocks than the value of the Threshold qualifier.

If you specify the Interval qualifier without specifying the number of seconds, or if you omit this qualifier, the default number of seconds is 60.

Oracle Corporation recommends using the default (Interval=60) initially because the interval that you choose can affect the performance of the database. In general, you can arrive at a good interval time on a given database only by judgment and experimentation.

If you specify the Nointerval qualifier, the active .aj file is tested repeatedly with no interval between finishing one cycle and beginning the next.

You must specify the Continuous qualifier if you specify either the Interval or Nointerval qualifier.

If you specify both the Interval and Nocontinuous qualifiers, the Interval qualifier is ignored.

Label=(label-name-list)

Specifies the 1- to 6-character string with which the volumes of the backup file are to be labeled. The Label qualifier is applicable only to tape volumes. You must specify one or more label names when you use the Label qualifier.

You can specify a list of tape labels for multiple tapes. If you list multiple tape label names, separate the names with commas and enclose the list of names within parentheses.

If you do not specify the Label (or Accept_Label) qualifier, Oracle RMU labels the first tape used for a backup operation with the first 6 characters of the backup file name. Subsequent default labels are the first 4 characters of the backup file name appended with a sequential number. For example, if your backup file is my_backup.rbf, the default tape labels are my_b, my_b01, my_b02, and so on.

1.11 RMU Backup After_Journal Command

When you reuse tapes, Oracle RMU compares the label currently on the tape to the label or labels you specify with the Label qualifier. If there is a mismatch between the existing label and a label you specify, Oracle RMU sends a message to the operator asking if the mismatch is acceptable (unless you also specify the Accept_Labels qualifier).

If desired, you can explicitly specify the list of tape labels for multiple tapes. If you list multiple tape label names, separate the names with commas and enclose the list of names within parentheses. If you are reusing tapes be certain that you load the tapes so that the label Oracle RMU expects and the label on each tape will match, or be prepared for a high level of operator intervention.

If you specify fewer labels than are needed, Oracle RMU generates labels based on the format you have specified. For example, if you specify Label=TAPE01, Oracle RMU labels subsequent tapes as TAPE02, TAPE03, and so on up to TAPE99. Thus, many volumes can be preloaded in the cartridge stacker of a tape drive. The order is not important because Oracle RMU relabels the volumes. An unattended backup operation is more likely to be successful if all the tapes used do not have to be mounted in a specific order.

Once the backup operation is complete, externally mark the tapes with the appropriate label so that the order can be maintained for the restore operation. Be particularly careful if you are allowing Oracle RMU to implicitly label second and subsequent tapes and you are performing an unattended backup operation. Remove the tapes from the drives in the order in which they were written. Apply labels to the volumes following the logic of implicit labeling (for example, TAPE02, TAPE03, and so on).

Oracle Corporation recommends you use the Journal qualifier when you employ implicit labeling in a multidrive, unattended backup operation. The journal file records the volume labels that were written to each tape drive. The order in which the labels were written is preserved in the journal. Use the RMU Dump Backup command to display a listing of the volumes written by each tape drive.

You can use an indirect file reference with the Label qualifier. See Section 1.3 for more information on using indirect file references. See Table 1–5 in the Usage Notes section for a summary of which labels are applied under a variety of circumstances.

Librarian[=options]

Use the Librarian qualifier to back up files to data archiving software applications that support the Oracle Media Management interface. The backup file name specified on the command line identifies the stream of data

1.11 RMU Backup After_Journal Command

to be stored in the Librarian utility. If you supply a device specification or a version number it will be ignored.

The Librarian qualifier accepts the following options:

- `Trace_file=file-specification`
The Librarian utility writes trace data to the specified file.
- `Level_Trace=n`
Use this option as a debugging tool to specify the level of trace data written by the Librarian utility. You can use a pre-determined value of 0, 1, or 2, or a higher value defined by the Librarian utility. The pre-determined values are :
 - Level 0 traces all error conditions. This is the default.
 - Level 1 traces the entry and exit from each Librarian function.
 - Level 2 traces the entry and exit from each Librarian function, the value of all function parameters, and the first 32 bytes of each read/write buffer, in hexadecimal.
- `Logical_Names=(logical_name=equivalence-value,...)`
You can use this option to specify a list of process logical names that the Librarian utility can use to specify catalogs or archives where Oracle Rdb backup files are stored, Librarian debug logical names, and so on. See the specific Librarian documentation for the definition of logical names. The list of process logical names is defined by Oracle RMU prior to the start of any Oracle RMU command that accesses the Librarian utility.

The following OpenVMS logical names must be defined for use with a Librarian utility before you execute an Oracle RMU backup or restore operation. Do not use the `Logical_Names` option provided with the Librarian qualifier to define these logical names.

- `RMU$LIBRARIAN_PATH`
This logical name must be defined so that the shareable Librarian image can be loaded and called by Oracle RMU backup and restore operations. The translation must include the file type (for example, `.exe`), and must not include a version number. The shareable Librarian image must be an installed (known) image. See the Librarian utility documentation for the name and location of this image and how it should be installed.
- `RMU$DEBUG_SBT`

1.11 RMU Backup After_Journal Command

This logical name is not required. If it is defined, Oracle RMU will display debug tracing information messages from modules that make calls to the Librarian shareable image.

You cannot use device specific qualifiers such as Rewind, Density, or Label with the Librarian qualifier because the Librarian utility handles the storage media, not Oracle RMU.

Lock_Timeout=seconds

Determines the maximum time the .ajj file backup operation will wait for the quiet-point lock during online backup operations. When you specify the Lock_Timeout=seconds qualifier, you must specify the number of seconds to wait for the quiet-point lock. If the time limit expires, an error is signaled and the backup operation fails.

The default value for the Lock_Timeout=seconds qualifier is the smaller of the value specified in the SET TRANSACTION statement and the value specified in CREATE or ALTER DATABASE. However, if the logical name RDM\$BIND_LOCK_TIMEOUT_INTERVAL is defined, the value of this logical name overrides the value specified in CREATE or ALTER DATABASE.

When the Lock_Timeout=seconds qualifier is not specified, or if the value specified is 0, the .ajj file backup operation waits indefinitely for the quiet-point lock during an online operation.

The Lock_Timeout=seconds qualifier is ignored if the Noquiet_Point qualifier is specified.

Log

Nolog

Specifies whether the processing of the command is reported to SYS\$OUTPUT. Specify the Log qualifier to request log output and the Nolog qualifier to prevent it. If you specify neither, the default is the current setting of the DCL verify switch. (The DCL SET VERIFY command controls the DCL verify switch.)

Media Loader

Nomedia Loader

Use the Media Loader qualifier to specify that the tape device receiving the backup file has a loader or stacker. Use the Nomedia Loader qualifier to specify that the tape device does not have a loader or stacker.

1.11 RMU Backup After_Journal Command

By default, if a tape device has a loader or stacker, Oracle RMU should recognize this fact. However, occasionally Oracle RMU does not recognize that a tape device has a loader or stacker. Therefore, when the first backup tape fills, Oracle RMU issues a request to the operator for the next tape, instead of requesting the next tape from the loader or stacker. Similarly, sometimes Oracle RMU behaves as though a tape device has a loader or stacker when actually it does not.

If you find that Oracle RMU is not recognizing that your tape device has a loader or stacker, specify the `Media_Loader` qualifier. If you find that Oracle RMU expects a loader or stacker when it should not, specify the `Nomedia_Loader` qualifier.

Owner_Uic=user-id

Synonymous with `Owner` qualifier. See the description of the `Owner` qualifier.

Owner=user-id

Specifies the owner of the tape volume set. The owner is the user who will be permitted to restore the database. The `user-id` parameter must be one of the following types of OpenVMS identifier:

- A user identification code (UIC) in [group-name,member-name] alphanumeric format
- A UIC in [group-number,member-number] numeric format
- A general identifier, such as `SECRETARIES`
- A system-defined identifier, such as `DIALUP`

The `Owner` qualifier cannot be used with a backup operation to disk. When used with tapes, the `Owner` qualifier applies to all continuation volumes. Unless the `Rewind` qualifier is also specified, the `Owner` qualifier is not applied to the first volume. If the `Rewind` qualifier is not specified, the backup operation appends the file to a previously labeled tape, so the first volume can have a protection different from the continuation volumes.

Prompt=Automatic

Prompt=Operator

Prompt=Client

Specifies where server prompts are to be sent. When you specify `Prompt=Automatic`, prompts are sent to the standard input device, and when you specify `Prompt=Operator`, prompts are sent to the server console. When you specify `Prompt=Client`, prompts are sent to the client system.

1.11 RMU Backup After_Journal Command

Protection=file-protection

Specifies the system file protection for the backup file produced by the RMU Backup After_Journal command.

The default file protection varies, depending on whether you backup the file to disk or tape. This is because tapes do not allow delete or execute access and the SYSTEM account always has both read and write access to tapes. In addition, a more restrictive class accumulates the access rights of the less restrictive classes.

If you do not specify the Protection qualifier, the default protection is as follows:

- S:RWED,O:RE,G,W if the backup is to disk
- S:RW,O:R,G,W if the backup is to tape

If you specify the Protection qualifier explicitly, the differences in protection applied for backups to tape or disk as noted in the preceding paragraph are applied. Thus, if you specify Protection=(S,O,G:W,W:R), that protection on tape becomes (S:RW,O:RW,G:RW,W:R).

Quiet_Point

Noquiet_Point

Specifies whether the quiet-point lock will be acquired when an .aj backup operation is performed. The default is the Quiet_Point qualifier. Use of the Quiet_Point qualifier is meaningful only for a full backup operation; that is, a backup operation that makes a complete pass through all .aj files ready for backup as opposed to one which is done by-sequence (specified with the Sequence qualifier). A full .aj backup operation can be performed regardless of whether an extensible or a fixed-size .aj journaling mechanism is being employed.

Each .aj backup operation is assigned an .aj sequence number. This labeling distinguishes each .aj backup file from previous .aj backup files. During a recovery operation, it is important to apply the .aj backup files in the proper sequence. The RMU Recover command checks the database root file structure and displays a message telling you the .aj sequence number with which to begin the recovery operation.

The quiet point is a state where all write transactions have either been committed or rolled back and no read/write transactions are in progress. This ensures that the recording of transactions do not extend into a subsequent .aj backup file. This backup file can then be used to produce a recovered database that is in the same state as when the quiet point was reached.

1.11 RMU Backup After_Journal Command

When fixed-size journaling is employed, the Quiet_Point qualifier is only relevant when the active .ajj file is being backed up. In this case, a quiet point is acquired only once, regardless of the number of .ajj files being backed up.

There is no natural quiet point if someone is writing or waiting to write to the database at any given time. (A natural quiet point is one that is not instigated by the use of the QP (quiet point) Lock.) The .ajj backup operation may never be able to capture a state that does not have uncommitted data in the database. As a result, the Noquiet_Point qualifier creates .ajj backup files that are not independent of one another. If you apply one .ajj backup file to the database without applying the next .ajj backup file in sequence, the recovery operation will not be applied completely.

See the Usage Notes section for recommendations on using the Quiet_Point and Noquiet_Point qualifiers.

The following combination of qualifiers on the same command line are invalid:

- Quiet_Point and Sequence
- Quiet_Point and Wait
- Noquiet_Point and Format=New

Rename

Norename

The Rename qualifier creates and initializes a new .ajj file and creates the backup file by renaming the original .ajj file. The effect is that the original .ajj file has a new name and the new .ajj file has the same name as the original .ajj file.

The Rename qualifier sets the protection on the renamed backup file so that you can work with it as you would any backup file. You can specify the new name by using the Edit_Filename qualifier.

When the Rename qualifier is used, the backup operation is faster (than when Norename, the default, is specified) because the duration of the backup operation is the total time required to rename and initialize the .ajj file; the data copy portion of the backup (reading and writing) is eliminated. However, the disk containing the .ajj file must have sufficient space for both the new and original .ajj files. Note also that the .ajj backup file name must not include a device specification.

1.11 RMU Backup After_Journal Command

Note

If there is insufficient space for both the new and original .ajj files when the Rename qualifier is specified, after-image journaling shutdown is invoked, resulting in a complete database shutdown.

The Rename qualifier can be used with both fixed-size and extensible journaling files.

The Norename qualifier copies the contents of the .ajj file on tape or disk and initializes the original .ajj file for reuse. The Norename qualifier results in a slower backup operation (than when Rename is specified), but it does not require space on the journal disk for both new and original .ajj files.

The default is Norename.

Rewind

Norewind

Specifies that the magnetic tape that contains the backup file will be rewound before processing begins. The tape is initialized according to the Label and Density qualifiers. The Norewind qualifier is the default and causes the backup file to be created starting at the current logical end-of-tape (EOT).

These qualifiers are applicable only to tape devices.

Sequence=(n,m)

Nosequence

Specifies that the journals with sequence numbers from *n* to *m* inclusive are to be backed up. The values *n* and *m* are interpreted or interpolated as follows:

- If Sequence = (33, 35) is specified, then the .ajj files with sequence numbers 33, 34, and 35 are backed up.
- If Sequence = (53, 53) is specified, then the .ajj file with sequence number 53 is backed up.
- If Sequence = (53) is specified, then the .ajj files with sequence numbers 53 and lower are backed up, if they have not been backed up already. For example, if .ajj files with sequence numbers 51, 52, and 53 have not been backed up, then Sequence = (53) results in these three .ajj files being backed up.
- If Sequence = (55, 53) is specified, then .ajj files with sequence numbers 53, 54, and 55 are backed up.

1.11 RMU Backup After_Journal Command

- If the Sequence qualifier is specified without a value list, both *n* and *m* are set to the sequence number of the next journal that needs to be backed up.

The default is the Nosequence qualifier. When the default is accepted, the backup operation starts with the next journal that needs to be backed up and stops when the termination condition you have specified is reached.

The following qualifiers cannot be used or have no effect when used with the Sequence qualifier:

- Continuous
- Format=New_Tape
- Interval
- Quiet_Point
- Threshold
- Until

Furthermore, fixed-size after-image journals must be in use when this qualifier is specified.

Tape_Expiration=date-time

Specifies the expiration date of the .aj backup file. Note that when Oracle RMU reads a tape, it looks at the expiration date in the file header of the first file on the tape and assumes the date it finds in that file header is the expiration date for the entire tape. Therefore, if you are backing up an .aj file to tape, specifying the Tape_Expiration qualifier only has meaning if the .aj file is the first file on the tape. You can guarantee that the .aj file will be the first file on the tape by specifying the Rewind qualifier and overwriting any existing files on the tape.

When the first file on the tape contains an expiration date in the file header, you cannot overwrite the tape before the expiration date unless you have the OpenVMS SYSPRV or BYPASS privilege.

Similarly, when you attempt to perform a recover operation with an .aj file on tape, you cannot perform the recover operation after the expiration date recorded in the first file on the tape unless you have the OpenVMS SYSPRV or BYPASS privilege.

By default, no expiration date is written to the .aj file header. In this case, if the .aj file is the first file on the tape, the tape can be overwritten immediately. If the .aj file is not the first file on the tape, the ability to overwrite the tape is determined by the expiration date in the file header of the first file on the tape.

1.11 RMU Backup After_Journal Command

You cannot explicitly set a tape expiration date for an entire volume. The volume expiration date is always determined by the expiration date of the first file on the tape. The Tape_Expiration qualifier cannot be used with a backup operation to disk.

See the *Oracle Rdb Guide to Database Maintenance* for information on tape label processing.

Threshold=disk-blocks

Nothreshold

This qualifier can be used only when extensible journaling is enabled. It cannot be used with fixed-size journaling.

The Threshold qualifier sets an approximate limit on the size of the active .aj file. When the size of the active .aj file exceeds the threshold, you cannot initiate new transactions until the backup process finishes backing up and truncating (resetting) the active .aj file. During the backup operation, existing transactions can continue to write to the .aj file. Before new transactions can start, all activity issuing from existing transactions (including activity occurring after the threshold is exceeded) must be moved from the active .aj disk file to the .aj backup file. At that time, the active .aj file will be completely truncated.

If you use the default, the Nothreshold qualifier, each backup cycle will completely back up the active .aj file. Oracle Corporation recommends using the Nothreshold qualifier.

An appropriate value for the Threshold qualifier depends on the activity of your database, how much disk space you want to use, whether backup operations will be continuous, and how long you are willing to wait for a backup operation to complete.

See the *Oracle Rdb7 Guide to Database Performance and Tuning* for more information on setting SPAM thresholds.

Until=time

Specifies the approximate future time and date to stop the continuous backup process. There is no default.

Wait=n

Nowait

Specifies whether the backup operation should wait (the Wait qualifier) or terminate (the Nowait qualifier) when it encounters a journal that is not ready to be backed up. The value specified for the Wait qualifier is the time interval in seconds between attempts to back up the journal that was not ready.

1.11 RMU Backup After_Journal Command

The Wait or Nowait qualifier can only be specified if the Sequence qualifier is also specified. When the Wait qualifier is specified, the default value for the time interval is 60 seconds.

The default is the Nowait qualifier.

Usage Notes

- To use the RMU Backup After_Journal command for a database, you must have the RMU\$BACKUP privilege in the root file access control list (ACL) for the database or the OpenVMS SYSPRV or BYPASS privilege.
- See the *Oracle Rdb7 Guide to Database Performance and Tuning* for information on how to enhance the performance of the RMU Backup After_Journal command.

Note

When fast commit is enabled and an extensible .ajj file configuration is used, the after-image journal backup process compresses and retains some fraction of the original .ajj file (in a new version of the current .ajj file). This fraction can approach 100% of the original size. Therefore, be sure to reserve enough space to duplicate the maximum size .ajj file before backing it up.

Oracle Corporation recommends that you schedule .ajj backup operations with sufficient frequency and check the free space and journal file size periodically; you need to know when you are approaching a critical situation in terms of free space. (This is good practice whether or not you have fast commit enabled.)

However, if you issue the RMU Backup After_Journal command with fast commit enabled and find that you have insufficient space for the .ajj file, you have the following options:

- Delete unneeded files to create sufficient space on the disk where the .ajj file is located.
- Temporarily disable fast commit and back up the .ajj file.
- Close the database, disable after-image journaling, enable a new after-image journal file, and perform a backup operation. (The database can be opened either before or after the backup operation.)

1.11 RMU Backup After_Journal Command

- Close the database. Create a bound volume set or stripe set that is large enough for the .aij file and copy the .aij file there. Use the RMU Set After_Journal command to change the .aij file name (or redefine the logical name if one was used to locate the journal), and then open the database again.
-
- Note the following issues and problems you can encounter when you specify the Format=Old_File qualifier for an .aij backup operation to tape or the Format=New_Tape qualifier for an .aij backup operation to disk:
 - If you use the Format=Old_File qualifier for an .aij backup operation to tape and the tape is mounted as a FOREIGN volume, the result is an unlabeled tape that can be difficult to use for recovery operations.
Therefore, if you use the Format=Old_File qualifier with an .aij backup operation to tape, you must mount the tape as an OpenVMS volume (that is, do not specify the /FOREIGN qualifier with the DCL MOUNT command).
 - You must remember (or record) the format you use when you back up your .aij file and specify that same format when you issue an RMU Dump After_Journal, RMU Optimize After_Journal, or RMU Recover command for the .aij backup file.
If you always follow the guidelines of specifying Format=New_Tape for tape backups and Format=Old_File for disk backups, you do not need to track the format you specified for the .aij backup operation for future use with the other Oracle RMU .aij commands.
 - If you specify Format=Old_File for a backup operation to tape and the .aij spans tape volumes, you might have problems recovering the .aij file.
 - You can use the RMU Backup After_Journal command to save disk space by spooling the .aij file to tape.
 - When you use extensible .aij files, note that although a new version of the .aij file might be created when the after-image backup operation begins, the old .aij file continues to be active and growing. Until the switch occurs (which could be several hours after the creation of the new version of the .aij file), the old .aij file is still being accessed. For this and other reasons, you should never use the DCL DELETE or DCL PURGE on .aij files (or any database files).

1.11 RMU Backup After_Journal Command

- The following list provides usage information for the Quiet_Point and Noquiet_Point qualifiers:
 - If the backup operation stalls when you attempt a quiet-point Oracle RMU backup operation, it may be because another user is holding the quiet-point lock. In some cases, there is no way to avoid this stall. However, you may find the stall is caused by a user who has previously issued and completed a read-write transaction, and is currently running a read-only transaction. When this user started the read-write transaction his or her process acquired the quiet-point lock. Ordinarily, such a process retains this lock until it detaches from the database.

You can set the RDM\$BIND_SNAP_QUIET_POINT logical name to control whether or not such a process retains the quiet-point lock. Set the value of the logical name to "1" to allow such a process to hold the quiet-point lock until they detach from the database. Set the value of the logical name to "0", to ensure that the process releases the quiet-point lock prior to starting a read-only transaction.

- When devising your backup strategy for both the database and the after-image journal files, keep in mind the trade-offs between performing quiet-point backup operations and noquiet-point backup operations. A noquiet-point backup operation is quicker than a quiet-point backup operation, but usually results in a longer recovery operation. Because transactions can span .aij files when you perform noquiet-point .aij backup operations, you might have to apply numerous .aij files to recover the database. In a worst-case scenario, this could extend back to your last quiet-point .aij or database backup operation. If you rarely perform quiet-point backup operations, recovery time could be excessive.

One method you can use to balance these trade-offs is to perform regularly scheduled quiet-point .aij backup operations followed by noquiet-point database backup operations. (You could do the converse, but a quiet-point backup of the .aij file improves the performance of the recovery operation should such an operation become necessary.) Periodically performing a quiet-point .aij backup operation helps to ensure that your recovery time will not be excessive.

- You cannot specify the Noquiet_Point qualifier with the Format=New_Tape qualifier because an .aij file created with the Noquiet_Point qualifier does not end on a quiet point. Some transactions can bridge several backup files. When you recover from these backup files you frequently must apply several backup files in the same RMU Recover command. However, the RMU Recover command with the

1.11 RMU Backup After_Journal Command

Format=New_Tape qualifier can only process one backup file at a time, so it cannot support backup files created with the Noquiet_Point qualifier.

- Oracle RMU tape operations do not automatically allocate the tape drives used. In an environment where many users compete for a few tape drives, it is possible for another user to seize a drive while Oracle RMU is waiting for you to load the next tape volume.

To prevent this, issue a DCL ALLOCATE command for the drives you will be using before you issue the Oracle RMU command, and then issue a DCL DEALLOCATE command after you complete the Oracle RMU command.

- The Label qualifier can be used with indirect file reference. See Section 1.3 for more information.
- If an .aij backup process fails or is terminated prematurely, the user might discard the resultant .aij backup file because the backup operation was not completed. However, all .aij backup files, including those produced by a failed backup process, are necessary to recover a database. If an .aij backup file of a failed backup process is discarded, the database is not recoverable from that point forward. This is especially important if you use magnetic tapes as the .aij backup media; in this case, preserve this magnetic tape and do *not* reuse it.
- When an .aij backup process, especially one running in continuous (Continuous) mode, writes to the .aij backup file, it is possible for the transferred data to be deleted from the database .aij file. If the backup process subsequently fails or is prematurely terminated (for example with Ctrl/Y or the DCL STOP command), it might not be possible to retransfer the data to the subsequent .aij backup file because the data was deleted from the active database .aij file.

Therefore, it is extremely important that you preserve *all* .aij backup files, even those produced by failed or terminated backup processes. If the resultant .aij backup file is discarded, the next .aij backup file could contain a “gap” in transactions, so that no transactions would ever be rolled forward from that point on.

This problem is more severe when backing up directly to tape. Therefore, when backing up to tape, you should back up one journal at a time, rather than using an open-ended or long-duration backup operation.

1.11 RMU Backup After_Journal Command

Note

If this problem occurs, the database is *not* inconsistent or corrupt. Rather, the database cannot be rolled forward past the discarded .aij backup file.

The solution to this problem is to preserve all .aij backup files to ensure that a database can be completely recovered.

If you have discarded an .aij backup file, perform a full and complete database backup operation immediately to ensure that the database can be restored up to the current transaction.

- When an AIJ backup operation completes, the after-image journal files are initialized with a pattern of -1 (hex FF) bytes. This initialization is designed to be as fast as possible. It fully utilizes the I/O subsystem by performing many large asynchronous I/O operations at once. However, this speed can come at the cost of a high load on I/O components during the initialization. This load could slow down other I/O operations on the system.

You can use two logical names to control the relative I/O load that the AIJ initialization operation places on the system. If you define these logical names in the system logical name table, they are translated each time an AIJ file is initialized.

The RDM\$BIND_AIJ_INITIALIZE_IO_COUNT logical name specifies the number of asynchronous I/O operations that are queued at once to the AIJ file. If the logical name is not defined, the default value is 15, the minimum value is 1, and the maximum value is 32.

The RDM\$BIND_AIJ_INITIALIZE_IO_SIZE logical name controls the number of 512-byte disk blocks to be written per I/O operation. If the logical name is not defined, the default value is 127, the minimum value is 4, and the maximum value is 127.

Reducing the value of either logical will probably increase the amount of time needed to initialize the AIJ file after a backup. However, it may also reduce load on the I/O subsystem.

- You should use the density values added in OpenVMS Version 7.2-1 for OpenVMS tape device drivers that accept them because previously supported values may not work as expected. If previously supported values are specified for drivers that support the OpenVMS Version 7.2-1 density values, the older values are translated to the Version 7.2-1 density values if possible. If the value cannot be translated, a warning message is generated, and the specified value is used.

1.11 RMU Backup After_Journal Command

If you use density values added in OpenVMS Version 7.2-1 for tape device drivers that do not support them, the values are translated to acceptable values if possible. If the value cannot be translated, a warning message is generated and the density value is translated to the existing default internal density value (MT\$K_DEFAULT).

One of the following density-related errors is generated if there is a mismatch between the specified density value and the values that the tape device driver accepts:

```
%DBO-E-DENSITY, TAPE_DEVICE:[000000]DATABASE.BCK; does not support
  specified density
```

```
%DBO-E-POSITERR, error positioning TAPE_DEVICE:
```

```
%DBO-E-BADDENSITY, The specified tape density is invalid for
  this device
```

- If you want to use an unsupported density value, use the VMS INITIALIZE and MOUNT commands to set the tape density. Do not use the Density qualifier.
- When you use the RMU Backup After_Journal command with the Log qualifier, the DCL global symbol RDM\$AIJ_LAST_OUTPUT_FILE is automatically created. The value of the symbol is the full output backup AIJ file specification.
- Because data stream names representing the database are generated based on the backup file name specified for the Oracle RMU backup command, you must either use a different backup file name to store the next backup of the database to the Librarian utility or first delete the existing data streams generated from the backup file name before the same backup file name can be reused.

To delete the existing data streams stored in the Librarian utility, you can use a Librarian management utility or the Oracle RMU Librarian/Remove command.

Examples

Example 1

Assuming that you have enabled after-image journaling for the MF_PERSONNEL database, the following command causes extensible .aij entries to be backed up continuously until the time specified.

```
$ RMU/BACKUP/AFTER_JOURNAL/CONTINUOUS/THRESHOLD=500 -
_$/INTERVAL=300/UNTIL="01-JUL-1996 16:15:00.00" -
_$/MF_PERSONNEL.RDB DISK12:[PERS_AIJ]BU_PERSONNEL.AIJ
```

1.11 RMU Backup After_Journal Command

Every 300 seconds, the backup process tests to determine if the active .aij file on disk has reached the threshold size of 500 blocks. If not, transaction processing continues normally for one or more 300-second intervals until the threshold test indicates that the active .aij file has reached a size of at least 500 blocks. When the .aij file reaches that file size, Oracle RMU allows existing transactions to continue to write to the active .aij file but does not allow new transactions to start.

Assuming that the active .aij file contains 550 blocks, Oracle Rdb moves those 550 blocks to the backup journal file and deletes them from the active journal file. Then, the backup process determines if the transactions already in progress have written more journal records to the active journal file during the backup operation. If so, Oracle RMU moves those journal records to the backup file.

After Oracle Rdb completely moves the active journal file, it truncates the journal file to 0 blocks. Oracle Rdb then allows new transactions to start and the backup process resumes threshold testing at 300-second intervals. The backup process continues until the time and date specified by the Until qualifier.

Example 2

The following examples show backing up .aij files in sequence. Note that a number of transactions were committed to the database between backup operations.

```
$ RMU/BACKUP/AFTER_JOURNAL/LOG MF_PERSONNEL MFPERS_BKUP_AIJ1.AIJ
%RMU-I-AIJBCKBEG, beginning after-image journal backup operation
%RMU-I-OPERNOTIFY, system operator notification:
  Oracle Rdb V8.0 Database DISK1:[DB]MF_PERSONNEL.RDB;1
  Event Notification AIJ backup operation started

%RMU-I-AIJBCKSEQ, backing up after-image journal
  sequence number 0
%RMU-I-LOGBCKAIJ, backing up after-image journal
  AIJ1 at 16:35:53.41
%RMU-I-LOGCREBCK, created backup file
  DISK1:[DB]MFPERS_BKUP_AIJ1.AIJ;1
%RMU-I-AIJBCKSEQ, backing up after-image journal
  sequence number 1
%RMU-I-LOGBCKAIJ, backing up after-image journal
  AIJ2 at 16:35:54.58
%RMU-I-QUIETPT, waiting for database quiet point
%RMU-I-OPERNOTIFY, system operator notification:
  Oracle Rdb V8.0 Database DISK1:[DB]MF_PERSONNEL.RDB;1
  Event Notification AIJ backup operation completed
```

1.11 RMU Backup After_Journal Command

```
%RMU-I-AIJBCKEND, after-image journal backup operation
  completed successfully
%RMU-I-LOGAIJJRN, backed up 2 after-image journals
  at 16:35:56.40
%RMU-I-LOGAIJBLK, backed up 508 after-image journal blocks
  at 16:35:56.41
.
.
.
$ More transactions committed to the database
.
.
.
$ RMU/BACKUP/AFTER_JOURNAL/LOG MF_PERSONNEL MFPERS_BKUP_AIJ2.AIJ
%RMU-I-AIJBCKBEG, beginning after-image journal backup operation
%RMU-I-OPERNOTIFY, system operator notification:
  Oracle Rdb V8.0 Database
  DISK1:[DB]MF_PERSONNEL.RDB;1 Event Notification
AIJ backup operation started

%RMU-I-AIJBCKSEQ, backing up after-image journal sequence number 2
%RMU-I-LOGBCKAIJ, backing up after-image journal AIJ1 at 16:47:44.66
%RMU-I-LOGCREBCK, created backup file
  DISK2:[AIJ]MFPERS_BKUP_AIJ2.AIJ;1
%RMU-I-OPERNOTIFY, system operator notification:
  Oracle Rdb V8.0 Database
  DISK1:[DB]MF_PERSONNEL.RDB;1 Event Notification
AIJ backup operation completed

%RMU-I-AIJBCKEND, after-image journal backup operation completed
  successfully
%RMU-I-LOGAIJJRN, backed up 1 after-image journal at 16:47:46.57
%RMU-I-LOGAIJBLK, backed up 254 after-image journal blocks at
  16:47:46.57
```

1.11 RMU Backup After_Journal Command

Example 3

The following example uses the Edit_Filename qualifier to give the .aij backup file a meaningful file name. The Rename qualifier specifies that Oracle RMU should create the backup file by renaming the current .aij file and by creating a new .aij file with the same name as the original .aij file.

```
$ RMU/BACKUP/AFTER_JOURNAL MF_PERSONNEL -
_ $ /EDIT_FILENAME=(SEQUENCE, "_", HOUR, "_", MINUTE, "_", MONTH, "_", -
_ $ DAY_OF_MONTH) AIJ2/RENAME
$ DIR DISK1:[DB.AIJ2]*.AIJ
Directory DISK1:[DB.AIJ_TWO]
AIJ23_15_46_07_09.AIJ;1
```

Example 4

The following example shows the syntax to use when you want the .aij backup file name to default to that previously specified with the RMU Set After_Journal command. Note that the .aij backup file name used is that which corresponds to the first .aij file included in the backup operation.

```
$ RMU/SET AFTER_JOURNAL MF_PERSONNEL /ENABLE/RESERVE=5 -
_ $ /ADD=(NAME=AIJ1, FILE=DISK1:[AIJ]AIJ_ONE, -
_ $ BACKUP_FILE=DISK4:[AIJBCK]AIJ1BCK) -
_ $ /ADD=(NAME=AIJ2, FILE=DISK2:[AIJ]AIJ_TWO, -
_ $ BACKUP_FILE=DISK4:[AIJBCK]AIJ2BCK) -
_ $ /ADD=(NAME=AIJ3, FILE=DISK3:[AIJ]AIJ_THREE, -
_ $ BACKUP_FILE=DISK4:[AIJBCK]AIJ3BCK)
%RMU-W-DOFULLBCK, full database backup should be done to
ensure future recovery
$ !
$ !Assume backup operation was performed and other database
activity occurs.
$ !Then back up the .aij files:
$ !
$ RMU/BACKUP/AFTER_JOURNAL MF_PERSONNEL.RDB " "
$ !
$ DIR DISK4:[AIJBCK]
Directory DISK4:[AIJBCK]
AIJ1BCK.AIJ;1
```

Example 5

The following example uses a density value with compression:

```
RMU/BACKUP/AFTER_JOURNAL /DENSITY=(TK89,COMPACTION)/REWIND -
/LABEL=(LABEL1,LABEL2) MF_PERSONNEL TAPE1:MFP.AIJ, TAPE2:
```

1.12 RMU Backup Plan Command

1.12 RMU Backup Plan Command

Executes a backup plan file previously created with the RMU Backup command (or created manually by the user).

Format

RMU/Backup/Plan plan-file

<u>Command Qualifiers</u>	<u>Defaults</u>
/[No]Execute	Execute
/List_Plan=output-file	None

Description

A backup plan file is created when you execute an RMU Backup command with the Parallel and List_Plan qualifiers. See Section 1.10 for details on creating a plan file and the format of a plan file.

Command Parameters

plan-file-spec

The file specification for the backup plan file. The default file extension is .plan.

Command Qualifiers

Execute

Noexecute

The Execute qualifier specifies that Oracle RMU is to execute the plan file. The Noexecute qualifier specifies that Oracle RMU should not execute the plan file, but instead perform a validity check on the contents of the plan file.

The validity check determines such things as whether the storage areas names assigned to each worker executor exist.

By default, Oracle RMU executes the backup plan file when the RMU Backup Plan command is issued.

List_Plan=output-file

Specifies that Oracle RMU should generate a new plan file and write it to the specified output file. This new plan file is identical to the plan file you specified on the command line (the “original” plan file) with the following exceptions:

1.12 RMU Backup Plan Command

- Any user-added comments in the original plan file do not appear in the new plan file.
- The new plan file is formatted to match the standard format for RMU Backup plan files.

Usage Notes

- To use the RMU Backup Plan command for a database, you must have the RMU\$BACKUP privilege in the root file access control list (ACL) for the database or the OpenVMS SYSPRV or BYPASS privilege.
- To execute the RMU Backup Plan command, Oracle SQL/Services must be installed on your system.

Examples

Example 1

The following example first creates a plan file by issuing an RMU Backup command with the Parallel and List_Plan qualifiers. Oracle RMU does not execute the plan file because the Noexecute qualifier is specified. The second command issues the RMU Backup Plan command to execute the plan file created with the RMU Backup command.

```
$ ! Create the Backup plan file:
$ !
$ RMU/BACKUP/PARALLEL=(EXEC=4, NODE=(NODE1, NODE2)) -
_ $ /LIST_PLAN=(PARTIAL.PLAN)/NOEXECUTE/INCLUDE=(RDB$SYSTEM, -
_ $ EMPIDS_LOW, EMPIDS_MID, EMPIDS_OVER, SALARY_HISTORY, EMP_INFO) -
_ $ /LABEL=(001, 002, 003, 004, 005, 006, 007, 008, 009) -
_ $ /CHECKSUM_VERIFICATION -
_ $ MF_PERSONNEL TAPE1:MF_PARTIAL.RBF, TAPE2:, TAPE3, TAPE4
$ !
$ ! Execute the plan file created with the previous command:
$ !
$ RMU/BACKUP/PLAN partial.plan

$ TYPE partial.plan
! Plan created on 3-JUL-1996 by RMU/BACKUP.

Plan Name = PARTIAL
Plan Type = BACKUP
```

1.12 RMU Backup Plan Command

```
Plan Parameters:
  Database Root File = DISK1:[DB]MF_PERSONNEL.RDB;1
  Backup File = MF_PARTIAL.RBF
  ! Journal = specification for journal file
  ! Tape_Expiration = dd-mmm-yyyy
  ! Active_IO = number of buffers for each tape
  ! Protection = file system protection for backup file
  ! Block_Size = bytes per tape block
  ! Density = tape density
  ![No]Group_Size = number of blocks between XOR blocks
  ! Lock_Timeout = number of second to wait for locks
  ! Owner = identifier of owner of the backup file
  ! Page_Buffers = number of buffers to use for each storage area
Checksum_Verification
CRC=AUTODIN_II
NoIncremental
! Accept_labels preserves all tape labels
Log
! Loader_synchronization labels tapes in order across drives
! Media_loader forces support of a tape media loader
NoOnline
Quiet_Point
NoRewind
Statistics
ACL
![No]Scan_Optimization
Labels = (-
          001      -
          002      -
          003      -
          004      -
          005      -
          006      -
          007      -
          008      -
          009      )
End Plan Parameters
Executor Parameters :
  Executor Name = COORDINATOR
  Executor Type = Coordinator
End Executor Parameters
```

1.12 RMU Backup Plan Command

```
Executor Parameters :
  Executor Name = WORKER_001
  Executor Type = Worker
  Executor Node = NODE1
  Start Storage Area List
    EMP_INFO,
    SALARY_HISTORY
  End Storage Area List
  Tape Drive List
    Tape Drive = TAPE1:
    MASTER
  End Tape Drive List
End Executor Parameters
Executor Parameters :
  Executor Name = WORKER_002
  Executor Type = Worker
  Executor Node = NODE2
  Start Storage Area List
    EMPIDS_LOW,
    RDB$SYSTEM
  End Storage Area List
  Tape Drive List
    Tape Drive = TAPE2:
    MASTER
  End Tape Drive List
End Executor Parameters
Executor Parameters :
  Executor Name = WORKER_003
  Executor Type = Worker
  Executor Node = NODE1
  Start Storage Area List
    EMPIDS_MID
  End Storage Area List
  Tape Drive List
    Tape Drive = TAPE3
    MASTER
  End Tape Drive List
End Executor Parameters
Executor Parameters :
  Executor Name = WORKER_004
  Executor Type = Worker
  Executor Node = NODE2
  Start Storage Area List
    EMPIDS_OVER
  End Storage Area List
  Tape Drive List
    Tape Drive = TAPE4
    MASTER
  End Tape Drive List
End Executor Parameters
```

1.13 RMU Checkpoint Command

When fast commit is enabled, requests that each active database process on each node flush updated database pages from its buffer pool to disk.

Format

RMU/Checkpoint root-file-spec

Command Qualifiers

/[No]Wait[/Until=date-and-time]

Default

/Wait

Description

Usually, each process performs a checkpoint operation after a certain set of thresholds has been exceeded. The RMU Checkpoint command allows you to spontaneously force each process to perform a checkpoint operation.

Performing a checkpoint operation is useful for several purposes. A checkpoint operation with the Wait qualifier causes all updated database pages to be flushed to disk. A checkpoint operation also improves the redo performance of the database recovery (DBR) process (although the per-process parameters should have already been properly initialized with this goal in mind).

When the Checkpoint command with the Wait qualifier completes (the system prompt is returned), all active processes have successfully performed a checkpoint operation.

When the system prompt is returned after you issue the Checkpoint command with the Nowait qualifier, there is no guarantee that all active processes have successfully performed a checkpoint operation.

Command Parameters

root-file-spec

The root file specification for the database you want to checkpoint. You can use either a full or partial file specification, or a logical name.

If you specify only a file name, Oracle Rdb looks for the database in the current default directory. If you do not specify a file extension, Oracle Rdb assumes a file extension of .rdb.

1.13 RMU Checkpoint Command

Command Qualifiers

Wait[/Until=date-and-time]

Nowait

Specifies whether or not the system prompt is to be returned before the checkpoint operation completes.

When you specify the Wait qualifier without the Until qualifier, the system prompt is not returned to you until all processes have flushed updated database pages to disk. The Wait qualifier is the default.

Used with the Wait qualifier, the Until qualifier specifies the time at which the RMU Checkpoint/Wait command stops waiting for the checkpoint and returns an error message. If you do not specify the Until qualifier, the wait is indefinite.

When you specify the Nowait qualifier, the system prompt is returned immediately, before all processes have flushed database pages to disk. In addition, when you specify the Nowait qualifier, there is no guarantee that all processes will flush their database pages to disk.

The Nowait qualifier is useful when it is more essential that the system prompt be returned immediately than it is to be certain that all processes have checkpointed.

Usage Notes

- To use the RMU Checkpoint command for a database, you must have the RMU\$BACKUP or RMU\$OPEN privilege in the root file access control list (ACL) for the database or you must have the OpenVMS WORLD privilege.
- The RMU Checkpoint command is useful only if the database fast commit feature has been enabled. If the fast commit feature is disabled, this command does nothing.

For more information on the fast commit feature, see the FAST COMMIT IS ENABLED section of the SQL ALTER DATABASE statement in the *Oracle Rdb SQL Reference Manual*.

1.13 RMU Checkpoint Command

Examples

Example 1

The following command causes all the active database processes on all nodes to immediately perform a checkpoint operation:

```
$ RMU/CHECKPOINT MF_PERSONNEL.RDB
```

Example 2

The following command requests that all the active database processes on all nodes perform a checkpoint operation and that the system prompt be returned to you immediately. In this case, there is no guarantee that all processes will actually perform a checkpoint operation.

```
$ RMU/CHECKPOINT/NOWAIT MF_PERSONNEL.RDB
```

1.14 RMU Close Command

1.14 RMU Close Command

Closes an open database.

You should always specify the Wait qualifier, unless you are attempting to recover from some failure. When you specify the Wait qualifier, Oracle RMU performs all the auxiliary actions required to close and recover the database clusterwide, and it does not return the system prompt until those actions have been completed.

If you use the RMU Close command with the Nowait qualifier, the database must be open on the node where you issue the command. Otherwise, you will receive an error message stating that the database is not known. The system prompt is returned immediately, but it is only an indication that the database will be closed as soon as all other users have finished accessing the database. Therefore, the Wait qualifier is used almost exclusively.

Format

RMU/Close root-file-spec [...]

<u>Command Qualifiers</u>	<u>Defaults</u>
/[No]Abort=option	/Abort=Forcex
/[No]Cluster	See description
/Path	None
/[No]Statistics=Export	/Nostatistics
/[No]Wait	/Nowait

Description

The RMU Close command closes an open database. A database root file is considered open if it has been specified in a previous RMU Open command or has active users attached to it.

You can close the database immediately by specifying the Abort qualifier, or you can allow current users to finish their session by specifying the Noabort qualifier.

If you have specified manual opening for your database (with the OPEN IS MANUAL clause of the SQL ALTER DATABASE statement), you must use the RMU Open command to manually open the database before any users can invoke it and the RMU Close command to manually close the database.

1.14 RMU Close Command

If you have specified automatic opening for your database (with the `OPEN IS AUTOMATIC` clause of the `SQL ALTER DATABASE` statement), the `RMU Close` command affects current database users only. Current processes are detached from the database but they and new processes can immediately reattach to the database.

Use the `RMU Show Users` command to display information about databases currently in use on your node. Use the `RMU Dump Users` command to display information about databases currently in use on your cluster.

Command Parameters

root-file-spec[,...]

An open database root file. The default file extension is `.rdb`.

Command Qualifiers

Abort=option

Noabort

Specifies whether to close the database immediately or allow processes to complete.

The `Abort` qualifier has two options. Both refer to OpenVMS system services. The options are as follows:

- **Forcex**
When you use the `Forcex` (forced exit) option, recovery units are recovered and no recovery-unit journal (`.ruj`) files are left in the directories. Therefore, the `RMU Backup` command works. The option cannot force an exit of a database process with a spawned subprocess or a suspended or swapped out process. It aborts batch jobs that are using the database. `Forcex` is the default.
- **Delprc**
When you use the `Delprc` (delete process) option, recovery units are not recovered. The `.ruj` files are left in the directories to be recovered on the next invocation of the database. The processes and any subprocesses of all database users are deleted, thereby deleting the processes from the database. Therefore, if you attempt to issue an `RMU Backup` command, you might receive the following error message:

```
%RMU-F-MUSTRECDB, database must be closed or recovered
```

The `Delprc` and `Forcex` options are based on OpenVMS system services `$DELPRC` and `$FORCEX`. Refer to the OpenVMS documentation set for more information.

1.14 RMU Close Command

With the Noabort option, users already attached to the database can continue, and the root file global sections remain mapped in the virtual address file contents until all users exit the database. No new users will be allowed to attach to the database. When all current images terminate, Oracle RMU closes the database.

Cluster

Nocluster

Specifying the Cluster qualifier causes Oracle RMU to attempt to close a database on all nodes in a clustered environment that currently have the database open. Specifying the Cluster qualifier is similar to issuing the RMU Close command on every node in the cluster. Specifying the Nocluster qualifier causes Oracle RMU to close a database only on the cluster node from which you issue the RMU Close command.

The default is the Cluster qualifier if you specify the Wait qualifier. The default is the Nocluster qualifier if you specify the Nowait qualifier.

The following list describes the behavior of the command when you use various combinations of the [No]Cluster and [No]Wait qualifiers together in the same command line:

- Cluster and Wait

When you specify the Cluster and Wait qualifiers, the RMU Close command closes the database on every node in the cluster, even if the database is not opened on the node from which the command is issued.

Because you specified the Cluster and Wait qualifiers, the RMU Close command closes and recovers the database on every node in the cluster before the DCL prompt is returned to you.

- Cluster and Nowait

When you specify the Cluster and Nowait qualifiers, the RMU Close command attempts to close the database on every node in the cluster. If the database is not opened on the node from which the Oracle RMU command is issued, the command cannot close the database on any node, and you receive the following error message:

```
%RDMS-F-CANTCLOSEDB, database could not be closed as requested
-RDMS-F-DBNOTACTIVE, database is not being used
%RMU-W-FATALERR, fatal error on DISK1:[USER1]DATABASE.RDB;1
```

Because you used the Nowait qualifier, the database might not yet be closed on one or more nodes when the DCL prompt is returned to you. When you specify the Nowait qualifier, you can receive SYS-F-ACCONFLICT errors when you attempt to access a database after you have issued the RMU Close command with the Cluster and Nowait qualifiers and the DCL

1.14 RMU Close Command

prompt has been returned, but the monitor has not yet closed the database on all nodes in the cluster.

- **Nocluster and Wait**

This combination provides the ability to have database shutdown complete on the local node before Oracle RMU returns to the DCL prompt.

- **Nocluster and Nowait**

When you specify the Nocluster and Nowait qualifiers, Oracle RMU closes the database only on the node from which you issue the command, regardless of whether or not the database is open on other nodes.

Because you used the Nowait qualifier, the database might not yet be closed on the node from which you issued the command when the DCL prompt is returned to you. With the Nowait qualifier, you can receive SYS-F-ACCONFLICT errors when you attempt to access a database after you have issued the RMU Close command with the Cluster and Nowait qualifiers and the DCL prompt has been returned, but the monitor has not yet closed the database on all nodes in the cluster.

Path

Specifies the full or relative data dictionary path name in which the definitions reside for the database you want to close.

The Path qualifier is a positional qualifier. Positional qualifiers operate on specific parameters based on the placement of the qualifiers in the command line. The path name cannot include wildcard characters.

Statistics=Export

Nostatistics

Specifies that statistic information is to be saved when the database is closed. The default is Nostatistics, which indicates that statistic information is not preserved when the database is closed.

Clusterwide statistic information is not stored in the statistic file, which allows you to decide on which nodes the statistic information should be initially loaded when the database is opened.

The statistic information is stored in a node-specific database file located in the same directory as the database root file. The file has the same name as the root-file-spec, with a default file extension of .rds. Because the statistic files contain node-specific information, they cannot be renamed or copied. They can be deleted if they are no longer needed.

1.14 RMU Close Command

The `Statistics=Export` qualifier cannot be specified in conjunction with the `Cluster` qualifier. To preserve the statistics information for a database open on a cluster, you must specifically close the individual nodes.

The `RMU Backup` command does not save the statistics files. They are considered temporary files and not part of the database.

Wait

Nowait

Specify the `Wait` qualifier to cause Oracle RMU to close and recover the database before the system prompt is returned to you.

The default is the `Nowait` qualifier. With the `Nowait` qualifier, the database might not be closed when the system prompt is returned to you. You can receive errors when you attempt to access a database after you issued the `RMU Close` command and the system prompt is returned, but before the monitor has closed the database.

See the Usage Notes for restrictions on using the `Wait` qualifier.

Usage Notes

- To use the `RMU Close` command for a database, you must have the `RMU$OPEN` privilege in the root file access control list (ACL) for the database or the `OpenVMS WORLD` privilege.
- To use the `Wait` qualifier, Oracle RMU requires that the database be recoverable for correct operation. It must be possible to attach to the database on a node where it is opened. There are database recovery failures that preclude further attaches to the database. When such a failure occurs, any attempt to attach to the database (for example, with an `SQL ATTACH` statement) causes the process to be deleted from the system. In other words, you are logged out.

In this situation, the `RMU Close` command with the `Wait` qualifier has the same effect as the `RMU Close` command with the `Cluster` and `Nowait` qualifiers. The operation does not wait, and it does not close the database unless it is opened on the node from which you issue the Oracle RMU command.

If you encounter this situation, enter the following command from a node on which the database is open to close the database:

```
$ RMU/CLOSE/CLUSTER/NOWAIT/ABORT=DELPRC
```

1.14 RMU Close Command

Examples

Example 1

When you issue the following command from a node in a cluster, the Cluster qualifier shuts down the database for the entire cluster, even if no users are on the node from which you issued the command. The Wait qualifier causes Oracle RMU to close the database before the system prompt is returned.

```
$ RMU/CLOSE/CLUSTER/WAIT MF_PERSONNEL.RDB
```

Example 2

The following command closes the mf_personnel database in the [.WORK] directory, all the databases in the [.TEST] directory, and the databases specified by the path names CDD\$TOP.FINANCE and SAMPLE_DB:

```
$ RMU/CLOSE DISK1:[WORK]MF_PERSONNEL, CDD$TOP.FINANCE/PATH, -  
_ $ DISK1:[TEST]*, SAMPLE_DB/PATH
```

1.15 RMU Collect Optimizer_Statistics Command

1.15 RMU Collect Optimizer_Statistics Command

Collects cardinality and storage statistics for the Oracle Rdb optimizer. Also collects workload statistics if a workload profile has been generated.

Format

RMU/Collect Optimizer_Statistics root-file

Command Qualifiers	Defaults
/Exclude_Tables=(table-list)	None
/[No]Indexes=(index-list)	/Indexes
/[No]Log[=file-name]	Current DCL verify value
/Row_Count=n	/Row_Count=100
/Statistics=(options)	/Statistics
/[No]System_Relations	/Nosystem_Relations
/[No]Tables=(table-list)	/Tables
/Transaction_Type=option	/Transaction_Type=Automatic

Description

The purpose of collecting optimizer statistics is to maintain up-to-date statistics that the Oracle Rdb optimizer uses to determine solution costs and cardinalities during query optimization.

You can collect cardinality and storage statistics by issuing the RMU Collect Optimizer_Statistics command. You can direct Oracle RMU to collect these statistics for particular tables or indexes by using the Tables, System_Relations, or Indexes qualifiers.

Before you can collect *workload* statistics, you must first generate a workload profile with SQL. The following list describes the general procedure for generating a workload profile and collecting workload statistics:

1. Enable workload profiling with the WORKLOAD COLLECTION IS ENABLED clause of the SQL ALTER DATABASE or SQL CREATE DATABASE statement.
SQL creates a new system table called RDB\$WORKLOAD.
2. Execute the queries for which you want the Oracle Rdb optimizer to have the best possible statistics.

1.15 RMU Collect Optimizer_Statistics Command

When you execute the queries, the optimizer determines which groups of columns are important for optimal processing of the query. These groups of columns are referred to as **workload column groups**. Note that a workload column group may actually contain only one column.

Each set of workload column groups is entered as a row in the RDB\$WORKLOAD system table.

At this point, the only data in the RDB\$WORKLOAD system table are the workload column groups, the tables with which the column group is associated, and the date they were entered into the table. No statistics are currently recorded in the RDB\$WORKLOAD system table.

3. In most cases, now you disable workload profiling with the SQL ALTER DATABASE WORKLOAD COLLECTION IS DISABLED clause.

Queries executed after you disable workload profiling are not scanned by the Oracle Rdb optimizer for workload column groups. You can leave the workload profiling enabled if the same queries are always executed. In such a case, no new rows are entered into the RDB\$WORKLOAD system table. However, if you anticipate that queries will be executed for which you do not want workload profiling to be enabled, you need to disable workload collection.

4. Execute an RMU Collect Optimizer_Statistics command with the Statistics=(Workload) qualifier.

Oracle RMU reads the RDB\$WORKLOAD system table to determine for which column groups it should collect statistics, and then collects the statistics.

5. Execute the queries previously profiled again.

The optimizer uses the statistics gathered by Oracle RMU to make a best effort at optimizing the profiled queries.

The following list provides some guidelines on when to issue the RMU Collect Optimizer_Statistics command and which Statistics qualifier options you should use:

- You should enable workload profiling and execute the RMU Collect Optimizer_Statistics command with the Statistics=(Workload) qualifier when you introduce new, complex, frequently used queries as part of your regular work.
- You should execute the RMU Collect Optimizer_Statistics command with the Statistics=(Storage) qualifier after you add metadata, such as new tables or indexes, to the database. In this case, you do not need to reenabling workload profiling.

1.15 RMU Collect Optimizer_Statistics Command

- You should execute the RMU Collect Optimizer_Statistics command with the Statistics=(Storage, Workload) qualifier when the data in the database has significantly increased, decreased, or changed. In this case, you do not need to reenable workload profiling.

The statistics you can gather with the RMU Collect Optimizer_Statistics command and a description of how the optimizer uses these statistics are summarized in Table 1–6.

Table 1–6 Statistics Gathered by the RMU Collect Optimizer_Statistics Command

Cardinality Statistics		
Statistic Gathered:	Definition:	Used by Optimizer to:
Table Cardinality	Number of rows in a table.	Determine solution cardinality.
Index Cardinality	Number of distinct key values in an index.	Estimate the number of index keys returned.
Index Prefix Cardinality	Number of distinct key values in leading parts of a multi-segmented B-tree index.	Estimate the number of index keys returned based on a sorted index range.
Workload Statistics		
Statistic Gathered:	Definition:	Used by Optimizer to:
Column Group Duplicity Factor	Average number of duplicates per distinct value in a column group. This is an estimated value.	Determine strategies for equiselections (selections with the IS NULL predicate or selection predicates with the equals (=) operator), equijoins, grouped aggregation (for example, the SQL GROUP BY clause), or projection operations (for example, the SQL DISTINCT clause).
Column Group Null Factor	Number of table rows with a NULL value in at least one column of a column group. This is an estimated value.	Estimate the effects of NULL data on equijoins and equiselections (because they imply the removal of rows with NULL values). Also used for estimating the cardinality of an outer join result.

(continued on next page)

1.15 RMU Collect Optimizer_Statistics Command

Table 1–6 (Cont.) Statistics Gathered by the RMU Collect Optimizer_Statistics Command

Storage Statistics		
Statistic Gathered:	Definition:	Used by Optimizer to:
Average Index Depth (sorted indexes only)	Average number of levels to traverse on a B-tree descent.	Estimate the cost of descending the B-tree. (A cross join with an inner table that is accessed by a sorted index involves repetitive B-tree descents.)
Index Key Clustering Factor	Average number of I/Os required to read one index key and all associated dbkeys during a hashed key lookup or a B-tree index scan, excluding the B-tree descent.	Improve the cost estimate of performing an index-only retrieval for hashed and sorted indexes.
Index Data Clustering Factor	Average number of I/Os required to fetch data rows using dbkeys associated with an index key.	Estimate the cost for fetching data rows from a sorted index scan or from a hash bucket.
Table Row Clustering Factor	The average number of I/Os required to read one row during a sequential scan of a table.	Estimate the cost of performing a sequential scan of a table.

Command Parameters

root-file-spec

Specifies the database for which statistics are to be collected. The default file type is .rdb.

Command Qualifiers

Exclude_Tables

Exclude_Tables=(table-list)

Specifies a list of database tables to be excluded from statistics collection and update for statistics used by the Rdb query optimizer. You must specify at least one list. You can specify an options file in place of a list of tables.

If the Exclude_Tables qualifier is used with the Tables qualifier in the same RMU Collect Optimizer command, the Exclude_Tables qualifier takes precedence. If the same table is specified in the table list for both qualifiers, that table is excluded from the statistics collection and update.

1.15 RMU Collect Optimizer_Statistics Command

Indexes

Indexes=(index-list)

Noindex

Specifies the index or indexes for which statistics are to be collected. If you do not specify an index-list, statistics for all indexes defined for the tables specified with the Tables qualifier are collected. If you specify an index-list, statistics are collected only for the named indexes. If you specify the Noindex qualifier, statistics for the index cardinality, average index depth, index key clustering factor, and index data clustering factor are not collected.

Specify the Notable qualifier if you do not want statistics collected for tables. (Remember, the Tables qualifier without a table-list is the default.)

The default is the Indexes qualifier without an index-list.

Log

Log=file-name

Nolog

Specifies how the values calculated for the statistics are to be logged. Specify the Log qualifier to have the information displayed to SYS\$OUTPUT. Specify the Log=file-spec qualifier to have the information written to a file. Specify the Nolog qualifier to prevent display of the information. If you do not specify any of variation of the Log qualifier, the default is the current setting of the DCL verify switch. (The DCL SET VERIFY command controls the DCL verify switch.)

Row_Count=n

Specifies the number of rows that are sent in a single I/O request when Workload Statistics are collected. You can experiment to find the value for *n* that provides the best performance and memory usage for your database and environment.

As you increase the value of *n*, you see an increase in performance at the expense of additional memory and overhead.

The minimum value you can specify for *n* is 1. The default value for *n* is 100.

Statistics[=(options)]

Specifies the type of statistics you want to collect for the items specified with the Tables, System_Relations, and Indexes qualifiers. If you specify the Statistics qualifier without an options list, all statistics are collected for the items specified.

1.15 RMU Collect Optimizer_Statistics Command

If you specify the Statistics qualifier with an options list, Oracle RMU collects types of statistics described in the following list. If you specify more than one option, separate the options with commas and enclose the options within parenthesis.

The Statistics qualifier options are:

- **Cardinality**
Collects the table cardinality for the tables specified with the Tables and System_Relations qualifiers and the index and index prefix cardinalities for the indexes specified with the Indexes qualifier. Because cardinalities are automatically maintained by Oracle Rdb, it is usually not necessary to collect cardinality statistics using the RMU Collect Optimizer_Statistics command unless you have previously explicitly disabled cardinality updates.
- **Workload**
Collects the Column Group, Duplicity Factor, and Null Factor workload statistics for the tables specified with the Tables and System_Relations qualifiers.
- **Storage**
Collects the following statistics:
 - Table Row Clustering Factor for the tables specified with the Tables qualifier
 - Index Key Clustering Factor, the Index Data Clustering Factor, and the Average Index Depth for the indexes specified with the Indexes qualifierSee Table 1–7 for information on the columns and tables used in the system relations to store these statistics.

System_Relations

Nosystem_Relations

Specifies that optimizer statistics are to be collected for system tables (relations) and their associated indexes.

If you do not specify the System_Relations qualifier, or if you specify the Nosystem_Relations qualifier, optimizer statistics are not collected for system tables or their associated indexes.

Specify the Noindex qualifier if you do not want statistics collected for indexes defined on the system tables.

The default is the Nosystem_Relations qualifier.

1.15 RMU Collect Optimizer_Statistics Command

Tables

Tables[=(table-list)]

Notables

Specifies the table or tables for which statistics are to be collected. If you specify a table-list, statistics for those tables and their associated indexes are collected. If you do not specify a table-list, statistics for all tables and their associated indexes in the database are collected. If you do not specify the Table qualifier, statistics for all tables are collected. If you specify the Notables qualifier, statistics for the table cardinality, table row clustering factor, column group duplicity factor, and column group null factor are not collected.

Specify the Noindex qualifier if you do not want statistics collected for indexes.

The Tables qualifier without a table-list is the default.

Transaction_Type=option

Allows you to specify the transaction mode for the transactions used to collect statistics. Valid options are:

- Automatic
- Read_Only
- Noread_Only

You must specify an option if you use this qualifier.

If you do not use any form of this qualifier, the Transaction_Type=Automatic qualifier is the default. This qualifier specifies that Oracle RMU is to determine the transaction mode used to collect statistics. If any storage area in the database (including those not accessed for collecting statistics) has snapshots disabled, the transactions used to collect data are set to read/write mode. Otherwise, the transactions to collect data are set to read-only mode.

The Transaction_Type=Read_Only qualifier specifies the transactions used to collect statistics be set to read-only mode. When you explicitly set the transaction type to read-only, snapshots need not be enabled for all storage areas in the database, but must be enabled for those storage areas from which statistics are collected. Otherwise, you receive an error and the collect optimizer statistics operation fails.

You might select this option if not all storage areas have snapshots enabled and you are collecting statistics on objects that are stored only in storage areas with snapshots enabled. In this case, using the Transaction_Type=Read_Only qualifier allows you to collect statistics and impose minimal locking on other users of the database.

1.15 RMU Collect Optimizer_Statistics Command

The `Transaction_Type=Noread_Only` qualifier specifies that the transactions used to collect statistics be set to read/write mode. You might select this option if you want to eradicate the growth of snapshot files that occurs during a read-only transaction and are willing to incur the cost of increased locking that occurs during a read/write transaction.

Usage Notes

- To use the `RMU Collect Optimizer_Statistics` command for a database, you must have the `RMU$ANALYZE` privilege in the root file access control list (ACL) for the database or the `OpenVMS SYSPRV` or `BYPASS` privilege.
- When you use the `SQL ALTER DATABASE` statement to set the `RDB$SYSTEM` storage area to read-only access for your database, the Oracle Rdb system tables in the `RDB$SYSTEM` storage area are also set to read-only access. When the Oracle Rdb system tables are set to read-only access:
 - Automatic updates to table and index cardinality are disabled.
 - Manual changes made to the cardinalities to influence the optimizer are not allowed.
 - The I/O associated with the cardinality update is eliminated.
- For indexes, the cardinality value is the number of unique entries for an index that allows duplicates. If the index is unique, Oracle Rdb stores zero for the cardinality, and uses the table cardinality instead. For tables, the cardinality value is the number of rows in the table. Oracle Rdb uses the cardinality values of indexes and tables to influence decisions made by the optimizer. If the actual cardinality values of tables and indexes are different from the stored cardinality values, the optimizer's performance can be adversely affected.
- As Oracle RMU performs the collect operation, it displays the maximum memory required to perform the operation. If the maximum amount required is not available, Oracle RMU makes adjustments to try to make use of the memory that is available. However, if after making these adjustments, memory is still insufficient, the collect operation skips the updates for the table causing the problem and continues with the operation. The skipped table is noted in the log file with the message, "Unable to allocate memory for <table-name>; default statistics values used."

1.15 RMU Collect Optimizer_Statistics Command

To avoid this problem, use the OpenVMS System Generation Utility (SYSGEN) to increase the VIRTUALPAGECNT parameter.

- If you prefer not to update optimizer statistics all at once, you can divide the work into separate commands. Oracle Corporation recommends that you collect Cardinality and Storage statistics in one RMU Collect Optimizer_Statistics command; and collect Workload statistics in a second command.
- You must decide if the improved performance provided by enabling and maintaining the workload profile is worth the cost. Generally speaking, it is worth the cost of maintaining this table for a stable set of queries that are run on a regular basis; it is not worth the cost of maintaining this table when the majority of your queries are ad hoc queries, each of which uses different access strategies.

For example, if the majority of queries that access the EMPLOYEES table use the EMPLOYEE_ID as the selection criteria and the queries are using the same access strategy, you might want to maintain a workload profile for the EMPLOYEES table. However, if some queries access the EMPLOYEES table through the EMPLOYEE_ID, some through the LAST_NAME, and others through the STATE, in an unpredictable manner, the queries are using different access strategies for which you probably do not want to maintain a workload profile.

- Index prefix cardinalities are cumulative values. For example, suppose an index contains three segments and the first segment has a cardinality of A; the second has a cardinality of B; and the third has a cardinality of C. Then the index prefix cardinality for the first segment is A; the index prefix cardinality for the second segment is A concatenated with B (A | B); and the index prefix cardinality for the third segment is A concatenated with B concatenated with C (A | B | C). Therefore, the prefix cardinality for last segment in an index is always equal to the total cardinality for the index. Likewise, if the index only contains one segment, the index prefix cardinality is equal to the total cardinality for the index. In these cases, because the index prefix cardinality is the same as the total index cardinality, Oracle RMU does not calculate an index prefix cardinality. Instead, Oracle RMU stores a value of "0" for the index prefix cardinality and the optimizer uses the value stored for the total index cardinality.
- Cardinality statistics are automatically maintained by Oracle Rdb. Physical storage and Workload statistics are only collected when you issue an RMU Collect Optimizer_Statistics command. To get information about the usage of Physical storage and Workload statistics for a given query, define the RDMS\$DEBUG_FLAGS logical name to be "O". For example:

1.15 RMU Collect Optimizer_Statistics Command

```
$ DEFINE RDM$DEBUG_FLAGS "0"
```

When you execute a query, if workload and physical statistics have been used in optimizing the query, you see a line such as the following in the command output:

```
~0: Workload and Physical statistics used
```

- Detected asynchronous prefetch should be enabled to achieve the best performance of this command. Beginning with Oracle Rdb V7.0, by default, detected asynchronous prefetch is enabled for databases created under Oracle Rdb V7.0 or converted to V7.0. You can determine the setting for your database by issuing the RMU Dump command with the Header qualifier.

If detected asynchronous prefetch is disabled, and you do not want to enable it for the database, you can enable it for your Oracle RMU operations by defining the following logicals at the process level:

```
$ DEFINE RDM$BIND_DAPF_ENABLED 1
$ DEFINE RDM$BIND_DAPF_DEPTH_BUF_CNT P1
```

P1 is a value between 10 and 20 percent of the user buffer count.

- You can delete entries from the workload profile with the RMU Delete Optimizer_Statistics command. See Section 1.18 for details.
- You can display entries from the workload profile with the RMU Show Optimizer_Statistics command. See Section 1.61.6 for details.
- Table 1–7 provides a summary of the system tables in which statistics gathered by the RMU Collect Optimizer_Statistics command are stored.

Table 1–7 System Tables Used to Store Optimizer Statistics

Statistic	System Table Name	Column Name
Table Cardinality	RDB\$RELATIONS	RDB\$CARDINALITY
Table Row Clustering Factor	RDB\$RELATIONS	RDB\$ROW_CLUSTER_FACTOR
Column Group Duplicity Factor	RDB\$WORKLOAD	RDB\$DUPLICITY_FACTOR

(continued on next page)

1.15 RMU Collect Optimizer_Statistics Command

Table 1–7 (Cont.) System Tables Used to Store Optimizer Statistics

Statistic	System Table Name	Column Name
Column Group Null Factor	RDB\$WORKLOAD	RDB\$NULL_FACTOR
Index Cardinality	RDB\$INDICES	RDB\$CARDINALITY
Index Prefix Cardinality	RDB\$INDEX_SEGMENTS	RDB\$CARDINALITY
Average Index Depth (B-Trees only)	RDB\$INDICES	RDB\$INDEX_DEPTH
Index Key Clustering Factor	RDB\$INDICES	RDB\$KEY_CLUSTER_FACTOR
Index Data Clustering Factor	RDB\$INDICES	RDB\$DATA_CLUSTER_FACTOR

Examples

Example 1

The following example collects cardinality statistics for the EMPLOYEES and JOB_HISTORY tables and their associated indexes. See the Usage Notes for an explanation for the value "0" for the index prefix cardinality.

```
$ RMU/COLLECT OPTIMIZER_STATISTICS mf_personnel.rdb -
_ $ /STATISTICS=(CARDINALITY)/TABLES=(EMPLOYEES, JOB_HISTORY) -
_ $ /INDEXES=(EMP_LAST_NAME,EMP_EMPLOYEE_ID, EMPLOYEES_HASH, -
_ $ JH_EMPLOYEE_ID, JOB_HISTORY_HASH)/LOG
Start loading tables... at 3-JUL-1996 09:35:25.19
Done loading tables... at 3-JUL-1996 09:35:25.91
Start loading indexes... at 3-JUL-1996 09:35:25.92
Done loading indexes... at 3-JUL-1996 09:35:26.49
Start collecting btree index stats... at 3-JUL-1996 09:35:28.17
Done collecting btree index stats... at 3-JUL-1996 09:35:28.23
Start collecting table & hash index stats... at 3-JUL-1996 09:35:28.23
Done collecting table & hash index stats... at 3-JUL-1996 09:35:28.52
Start calculating stats... at 3-JUL-1996 09:35:28.76
Done calculating stats... at 3-JUL-1996 09:35:28.76
Start writing stats... at 3-JUL-1996 09:35:30.16
-----
Optimizer Statistics collected for table : EMPLOYEES
Cardinality          : 100
```

1.15 RMU Collect Optimizer_Statistics Command

```
Index name : EMP_LAST_NAME
  Index Cardinality      : 83
  Segment Column        LAST_NAME      Prefix cardinality
                                     0
Index name : EMP_EMPLOYEE_ID
  Index Cardinality      : 100
  Segment Column        EMPLOYEE_ID    Prefix cardinality
                                     0
Index name : EMPLOYEES_HASH
  Index Cardinality      : 100
```

Optimizer Statistics collected for table : JOB_HISTORY

```
  Cardinality            : 274
Index name : JH_EMPLOYEE_ID
  Index Cardinality      : 100
  Segment Column        EMPLOYEE_ID    Prefix cardinality
                                     0
Index name : JOB_HISTORY_HASH
  Index Cardinality      : 100
Done writing stats.... at 3-JUL-1996 09:35:30.83
```

Example 2

The following example collects storage statistics for the EMPLOYEES and JOB_HISTORY TABLES and their associated indexes:

```
$ RMU/COLLECT OPTIMIZER_STATISTICS mf_personnel -
_$/STATISTICS=(STORAGE)/TABLES=(EMPLOYEES, JOB_HISTORY) -
_$/INDEXES=(EMP_LAST_NAME,EMP_EMPLOYEE_ID, EMPLOYEES_HASH, -
_$/JH_EMPLOYEE_ID, JOB_HISTORY_HASH)/LOG
Start loading tables... at 3-JUL-1996 10:28:49.39
Done loading tables.... at 3-JUL-1996 10:28:50.30
Start loading indexes... at 3-JUL-1996 10:28:50.30
Done loading indexes.... at 3-JUL-1996 10:28:51.03
Start collecting btree index stats... at 3-JUL-1996 10:28:53.27
Done collecting btree index stats... at 3-JUL-1996 10:28:53.37
Start collecting table & hash index stats... at 3-JUL-1996 10:28:53.38
Done collecting table & hash index stats... at 3-JUL-1996 10:28:53.80
Start calculating stats... at 3-JUL-1996 10:28:54.07
Done calculating stats.... at 3-JUL-1996 10:28:54.07
Start writing stats... at 3-JUL-1996 10:28:55.61
```

Optimizer Statistics collected for table : EMPLOYEES

```
  Row clustering factor : 0.2550000
```

1.15 RMU Collect Optimizer_Statistics Command

```
Index name : EMP_LAST_NAME
  Average Depth      : 2.0000000
  Key clustering factor : 0.0481928
  Data clustering factor : 1.1686747

Index name : EMP_EMPLOYEE_ID
  Average Depth      : 2.0000000
  Key clustering factor : 0.0100000
  Data clustering factor : 0.9500000

Index name : EMPLOYEES_HASH
  Key clustering factor : 1.0000000
  Data clustering factor : 1.0000000
```

Optimizer Statistics collected for table : JOB_HISTORY

```
  Row clustering factor : 0.0930657

Index name : JH_EMPLOYEE_ID
  Average Depth      : 2.0000000
  Key clustering factor : 0.0500000
  Data clustering factor : 0.9500000

Index name : JOB_HISTORY_HASH
  Key clustering factor : 1.0000000
  Data clustering factor : 1.0000000
Done writing stats.... at 3-JUL-1996 10:28:56.41
```

Example 3

The following example enables workload collection with an SQL ALTER DATABASE statement, executes frequently run queries to generate a workload profile, collects workload statistics for the EMPLOYEES and JOB_HISTORY tables (along with their associated indexes), and then displays the statistics gathered.

The SQL natural left outer join causes the first and third workload column groups to be created. The SQL DISTINCT clause causes the second and fourth workload column groups to be created.

1.15 RMU Collect Optimizer_Statistics Command

```
$ ! Enable workload collection:
$ SQL
SQL> ALTER DATABASE FILENAME mf_personnel.rdb
cont> WORKLOAD COLLECTION IS ENABLED;
SQL> --
SQL> -- Execute frequently run SQL queries.
SQL> --
SQL> ATTACH 'FILENAME mf_personnel.rdb';
SQL> SELECT DISTINCT *
cont> FROM JOB_HISTORY NATURAL LEFT OUTER JOIN EMPLOYEES;
.
.
.
SQL> DISCONNECT DEFAULT;
SQL> -- Disable workload collection:
SQL> ALTER DATABASE FILENAME mf_personnel.rdb
cont> WORKLOAD COLLECTION IS DISABLED;
SQL> EXIT;
$
$ ! Direct Oracle RMU to collect statistics for the EMPLOYEES and
$ ! JOB_HISTORY tables.
$ !
$ RMU/COLLECT OPTIMIZER_STATISTICS mf_personnel.rdb -
_ $ /TABLE=(EMPLOYEES, JOB_HISTORY)/STATISTICS=(WORKLOAD)/LOG
Start loading tables... at 3-JUL-1996 10:40:00.22
Done loading tables.... at 3-JUL-1996 10:40:00.90
Start collecting workload stats... at 3-JUL-1996 10:40:03.43
Maximum memory required (bytes) = 6810
Done collecting workload stats... at 3-JUL-1996 10:40:05.03
Start calculating stats... at 3-JUL-1996 10:40:05.32
Done calculating stats.... at 3-JUL-1996 10:40:05.32
Start writing stats... at 3-JUL-1996 10:40:06.91

-----

Optimizer Statistics collected for table : EMPLOYEES

Workload Column group :      EMPLOYEE_ID
Duplicity factor      : 1.0000000
Null factor           : 0.0000000

Workload Column group : LAST_NAME,   FIRST_NAME,   MIDDLE_INITIAL,
ADDRESS_DATA_1, ADDRESS_DATA_2, CITY,   STATE,   POSTAL_CODE,   SEX,
BIRTHDAY,           STATUS_CODE
Duplicity factor      : 1.5625000
Null factor           : 0.3600000

-----

Optimizer Statistics collected for table : JOB_HISTORY

Workload Column group :      EMPLOYEE_ID
Duplicity factor      : 2.7040000
Null factor           : 0.0000000
```

1.15 RMU Collect Optimizer_Statistics Command

```
Workload Column group : EMPLOYEE_ID,      JOB_CODE,      JOB_START,
JOB_END,      DEPARTMENT_CODE,      SUPERVISOR_ID
Duplicity factor      : 1.5420582
Null factor           : 0.3649635
Done writing stats.... at 3-JUL-1996 10:40:07.46
```

Example 4

The following example collects all statistics (cardinality, workload, and storage) for all tables and indexes in the database except system relations. Output is written to the file stats_nosys.log.

```
$ RMU/COLLECT OPTIMIZER_STATISTICS mf_personnel.rdb -
_$ /LOG=stats_nosys.log
```

Example 5

The following example collects all statistics (cardinality, workload, and storage) for all tables, indexes, and system relations. Output is written to the file stats_all.log.

```
$ RMU/COLLECT OPTIMIZER_STATISTICS mf_personnel.rdb/SYSTEM_RELATIONS -
_$ /LOG=stats_all.log
```

Example 6

In the following example the Employees and Departments tables are excluded from statistics collection.

```
$ RMU/COLLECT OPTIMIZER_STATISTICS MF_PERSONNEL /LOG -
_$ /EXCLUDE_TABLES=(EMPLOYEES,DEPARTMENTS)
```

1.16 RMU Convert Command

Converts any of the following versions (or any of the mandatory updates to these versions) of Oracle Rdb databases to an Oracle Rdb release 7.2 database:

- Version 7.0
- Version 7.1

See the *Oracle Rdb Installation and Configuration Guide* for the proper backup procedure prior to installing a new release of Oracle Rdb and converting databases.

Note

The following are important issues to consider when you convert a database:

- A database *must* be backed up immediately following an Oracle RMU convert operation.

A database converted using the RMU Convert command may not be recoverable if a full database backup is not made immediately after the convert operation completes. If you attempt to restore a database using a backup file created prior to the conversion, the database may be left in an unrecoverable state.

- If after-image journaling is enabled when you issue the Convert command, Oracle RMU disables after-image journaling during the convert operation and then does one of the following, depending on the type of .ajj file or files being employed when the Convert command was issued:
 - If an extensible .ajj file was being used, Oracle RMU creates a new journal for the converted database and enables after-image journaling.
 - If fixed-size .ajj files were being used, Oracle RMU activates the next available fixed-size journal and enables after-image journaling. If another fixed-size journal is not available, journaling remains disabled.

Use only the .ajj file (or files) created or activated during or after the convert operation together with the backup file you created immediately after the convert operation to restore and recover your database. Any .ajj files created prior to the Convert operation cannot be used to recover the converted database.

1.16 RMU Convert Command

If you issue an RMU Convert command with the Rollback qualifier, Oracle RMU disables after-image journaling and returns the message: RMU-I-CANTENAAIJ. Oracle Corporation recommends that you back up the database and enable after-image journaling when the convert operation completes.

- Growth of the RDB\$SYSTEM storage area is normal during a convert operation. You must be sure that there is sufficient disk space for the new metadata and the converted metadata.

During a convert operation Oracle RMU makes an upgraded copy of the metadata. If the convert operation fails, the old metadata is available for rolling back. If you specify the Nocommit qualifier, both copies of the metadata exist at the same time (to allow a manual rollback operation). If you specify the Commit qualifier, the old metadata is deleted once the convert operation completes successfully.

Read the Description section carefully for important information on converting single-file and multifile databases.

Format

RMU/Convert database-list

Command Qualifiers

/[No]Commit
/[No]Confirm
/Path
/Prefix_Collection=option
/Reserve = (Area=n, Aij=n)
/[No]Rollback

Defaults

/Commit
See description
None
See description
See description
/Norollback

Description

The RMU Convert command operates by creating a converted copy of the system tables and indexes. This implies that the RDB\$SYSTEM storage area might grow during the conversion, but it is unlikely that the system tables will be fragmented by the conversion process.

1.16 RMU Convert Command

Because a copy of the system tables is made, the time taken by the conversion is proportional to the amount of storage allocated to the system tables, or the number of rows in system tables, or both. This is typically a few minutes per database. However, if the database has very large system tables, the conversion can be costly. If the database has a large number of versions of some tables, it might be more efficient for you to use the SQL EXPORT and IMPORT statements to convert the database.

After the conversion, both copies of the system tables are stored in the database. The Commit qualifier selects the converted copy and deletes the original copy. The Rollback qualifier selects the original copy and deletes the converted copy. You can specify either the Commit or the Rollback qualifier at a later time if you selected the Nocommit qualifier when the database was converted.

While both copies of the system tables exist, the database is usable under Oracle Rdb release 7.1, but not under the earlier version. Also, DDL (data definition language) operations to the database are prohibited to ensure that both copies of the system tables remain consistent. After you specify either the Commit or the Rollback qualifier, you can again perform DDL operations on the database.

If you convert a multfile database created prior to Oracle Rdb Version 6.1 by using the RMU Convert command with the Nocommit qualifier and then use the RMU Convert command with the Rollback qualifier to revert to the prior database structure level, subsequent verify operations might return an RMU-W-PAGTADINV warning message. See the Usage Notes section for details.

Command Parameters

database-list

The database-list parameter is a list of databases to be converted. A list item can be either the file specification of a database root file or a data dictionary path name.

You can use wildcards in the file specification of a database root file.

You cannot use wildcards in a data dictionary path name.

Command Qualifiers

Commit

1.16 RMU Convert Command

Nocommit

Makes the database conversion permanent. When you specify the Commit qualifier, the database is converted to an Oracle Rdb release 7.1 database and cannot be returned to the previous version. The default is Commit.

When you specify the Nocommit qualifier, you can convert the database to Oracle Rdb release 7.1 and roll it back to the previous version at a later time.

Using the Nocommit qualifier is helpful when you want to test your applications against a new version of Oracle Rdb. In the event that you find problems, you can roll back to the previous version. Once you feel confident that your applications work well with the new version, you can commit the converted database.

Confirm

Noconfirm

Requests user input during the conversion procedure. When you specify the Confirm qualifier, Oracle RMU asks if you are satisfied with your database and aij backup files. If the database being converted has after-image journaling enabled, Oracle RMU asks if you want to continue and states that after-image journaling will be temporarily disabled.

Path

Identifies that the database is being specified by its data dictionary path name instead of its file specification. The Path qualifier is a positional qualifier.

Prefix_Collection=option

When you convert a database to release 7.1 from a release of Oracle Rdb prior to release 7.0, you can use the Prefix_Collection qualifier to specify that sorted index prefix cardinality collection be Enabled, Enabled Full, or Disabled for all system and user sorted indexes.

The following options are available for use with the Prefix_Collection qualifier:

- Disabled
Specifies that index prefix cardinality collection is to be disabled.
- Enabled
Specifies that default collection is performed. The Oracle Rdb optimizer collects approximate cardinality values for the index columns to help in future query optimization.
Enabled Estimate
Specifies that prefix cardinality values for all indexes are to be estimated.
- Enabled Collect

1.16 RMU Convert Command

Specifies that prefix cardinality values for all indexes are to be collected by calling the RMU Collect command.

- Full Requests that extra I/O be performed, if required, to ensure that the cardinality values reflect the key value changes of adjacent index nodes.
- Full=Estimate
Specifies that prefix cardinality values for all indexes are to be estimated.
- Full=Collect
Specifies that prefix cardinality values for all indexes are to be collected by calling the RMU Collect command.

Reserve=(Area=n, Aij=n)

Reserves space in the database root file for storage areas or .aij files, or both. Replace the character *n* with the number of storage areas or .aij files for which you want to reserve space.

Note that you cannot reserve areas for a single-file database. You can reserve .aij files for a single-file database, but once the database is converted, you cannot alter that reservation unless you backup and restore the database.

This qualifier is useful if, when you are converting your database, you anticipate the need for additional storage areas or .aij files. Because the addition of new storage areas or .aij files requires that users not be attached to the database, adding them while the database is being converted minimizes the time that the database is inaccessible to users.

By default, one .aij file and no storage area files are reserved.

Rollback

Norollback

Returns a database that has been converted to an Oracle Rdb release 7.2 database (but not committed) to the previous version. You might decide to return to the previous version of the database for technical, performance, or business reasons.

The Norollback qualifier prevents you from returning your converted database to the previous version. The default is the Norollback qualifier.

If you specify both the Nocommit qualifier and the Rollback qualifier in the same RMU Convert command, your database is converted to Oracle Rdb release 7.2 and immediately rolled back to the previous version when the RMU Convert command is executed.

This qualifier is valid only if you are converting from one of the following releases: 7.0 or 7.1.

1.16 RMU Convert Command

Usage Notes

- To use the RMU Convert command for a database, you must have the `RMU$CONVERT` or `RMU$RESTORE` privilege in the root file access control list (ACL) for the database or the OpenVMS `SYSPRV` or `BYPASS` privilege.
- The RMU Convert command requires read/write access to the database root file, the `RDB$SYSTEM` area, and the directory in which the `.ruj` file will be entered.
- Oracle Corporation recommends that you update multisegment index cardinalities as part of, or soon after, the convert operation completes. Stored cardinality values can differ from the actual cardinality values if the `RDB$SYSTEM` storage area has been set to read-only access.
If you use the `Confirm` and `Commit` qualifiers when you issue the RMU Convert command, Oracle RMU asks if you want to update multisegment index cardinalities with actual index values and provides an estimate on the time it will take to perform the update. If you choose not to update these cardinalities with actual values as part of the convert operation, or if you do not use the `Confirm` qualifier, Oracle RMU updates the multisegment index cardinalities with estimated values. In such a case, you should update the cardinalities with actual values as soon as possible by issuing an `RMU Collect Optimizer_Statistics` command. See Section 1.15 for details.
- If the database conversion does not complete (for example, because of a system failure or an Oracle Rdb monitor shutdown), you can execute the RMU Convert command again later. The ability to complete the conversion process later keeps you from having a half-converted database that is corrupted.
- If the `RDB$SYSTEM` storage area attribute is set to read-only access, the RMU Convert command proceeds to convert the database and resets the attribute to read/write access for the converted database. Use the `SQL ALTER DATABASE` statement to reset the attribute to read-only access. If the `RDB$SYSTEM` storage area is located on a device that cannot be written to, the database conversion fails and returns an error message.
- You are prompted to specify the `Prefix_Collection` parameters if the following conditions are true:
 - The `Prefix_Collection` qualifier is not specified.

1.16 RMU Convert Command

- The RMU Convert process is not running as a batch job.
- The Noconfirm qualifier is not specified.

As a response to the prompt, you can enter "E(NABLE)" for the equivalent of Prefix_Collection=Enabled, "F(ULL)" for the equivalent of Prefix_Collection=Full, "D(ISABLE)" for the equivalent of Prefix_Collection=Disabled, or the default of "I(GNORE)" if you do not want to change any prefix cardinality settings.

Examples

Example 1

The first command in the following example converts an Oracle Rdb release 7.0 database with an extensible .aij file to an Oracle Rdb release 7.2 database. Because the Nocommit qualifier is specified in the first command, you can roll back the converted database (the Oracle Rdb release 7.2 database) to the original Oracle Rdb release 7.0 database.

After-image journaling is disabled while the database is being converted. After the database is converted, a new extensible .aij file is created and after-image journaling is enabled again. Note that .aij files are version-specific. You should perform a full backup operation after a conversion because the old version and the new version of the .aij file are incompatible.

In the second command, the converted database is rolled back to the original database.

```
$RMU/CONVERT/CONFIRM/NOCOMMIT MF_PERSONNEL.RDB
%RMU-I-RMUTXT_000, Executing RMU for Oracle Rdb V7.2-00
Are you satisfied with your backup of
  DISK1:[TESTS]MF_PERSONNEL.RDB;1
and your backup of any associated .aij files [N]? Y
%RMU-I-AIJ_DISABLED, after-image journaling is being disabled
temporarily for the Convert operation
%RMU-I-LOGCONVRT, database root converted to current structure level
%RMU-S-CVTDBSUC, database DISK1:[TESTS]MF_PERSONNEL.RDB;1 successfully
converted from version V7.0 to V7.2
%RMU-I-LOGCREAIJ, created after-image journal file
  DISK1:[TESTS]BACKUP_AFTER1.AIJ;2
%RMU-I-LOGMODSTR,      activated after-image journal "AFTER1"
%RMU-W-DOFULLBCK, full database backup should be done to ensure future recovery
```

1.16 RMU Convert Command

```
$RMU/CONVERT/ROLLBACK MF_PERSONNEL.RDB
%RMU-I-RMUTXT_000, Executing RMU for Oracle Rdb V7.2-00
Are you satisfied with your backup of
  DISK1:[TESTS]MF_PERSONNEL.RDB;1 and your backup of
  any associated .aij files [N]? Y
%RMU-I-AIJ_DISABLED, after-image journaling is being disabled
  temporarily for the Convert operation
%RMU-I-LOGCONVRT, database root converted to current structure level
%RMU-I-CVTROLSUC, CONVERT rolled-back for DISK1:[TESTS]MF_PERSONNEL.RDB;1
  to version V7.0
%RMU-I-CANTENAAIJ, The JOURNAL is now DISABLED. RMU CONVERT can not enable
  the JOURNAL for previous versions. You must do this manually.
%RMU-W-DOFULLBCK, full database backup should be done to ensure future recovery
```

1.16 RMU Convert Command

Example 2

This example is the same as Example 1, except fixed-size .aij journals are being employed at the time of the conversion. The first command in this example converts an Oracle Rdb release 7.1 database with fixed-size .aij files to an Oracle Rdb release 7.2 database. Because the Nocommit qualifier is specified in the first command, you can roll back the converted database (the Oracle Rdb release 7.2 database) to the original Oracle Rdb V7.1 database.

After-image journaling is disabled while the database is being converted. After the database is converted, Oracle RMU activates the next fixed-size .aij file and enables after-image journaling. Note that .aij files are version specific. You should perform a full backup operation after a conversion because the old .aij files are incompatible with the newly converted database.

In the second command, the converted database is rolled back to the original database.

```
$RMU/CONVERT/CONFIRM/NOCOMMIT MF_PERSONNEL.RDB
%RMU-I-RMUTXT_000, Executing RMU for Oracle Rdb V7.2-00
Are you satisfied with your backup of DISK1:[TESTS]MF_PERSONNEL.RDB;1
and your backup of any associated .aij files [N]? Y
%RMU-I-AIJ_DISABLED, after-image journaling is being disabled
temporarily for the Convert operation
%RMU-I-LOGCONVRT, database root converted to current structure level
%RMU-S-CVTDBSUC, database DISK1:[TESTS]MF_PERSONNEL.RDB;1 successfully
converted from version V7.1 to V7.2
%RMU-I-LOGMODSTR, activated after-image journal "AFTER2"
%RMU-W-DOFULLBCK, full database backup should be done to ensure future recovery

$RMU/CONVERT/ROLLBACK MF_PERSONNEL.RDB
%RMU-I-RMUTXT_000, Executing RMU for Oracle Rdb V7.2-00
Are you satisfied with your backup of
DISK1:[TESTS]MF_PERSONNEL.RDB;1 and your backup of
any associated .aij files [N]? Y
%RMU-I-AIJ_DISABLED, after-image journaling is being disabled
temporarily for the Convert operation
%RMU-I-LOGCONVRT, database root converted to current structure level
%RMU-I-CVTROLSUC, CONVERT rolled-back for
DISK1:[TESTS]MF_PERSONNEL.RDB;1 to version V7.1
%RMU-I-CANTENAAIJ, The JOURNAL is now DISABLED. RMU CONVERT can not
enable the JOURNAL for previous versions. You must do this manually.
%RMU-W-DOFULLBCK, full database backup should be done to ensure future recovery
```

Example 3

The following command converts all the databases in DISK1:[RICK] and its subdirectories and also the SPECIAL_DB database that is identified by its data dictionary path name. The Noconfirm qualifier is specified, so Oracle RMU does not request user input. The Nocommit qualifier is not specified, so

1.16 RMU Convert Command

the default qualifier, Commit, is used by default and the converted databases cannot be rolled back.

```
$ RMU/CONVERT/NOCONFIRM DISK1:[RICK...]*.RDB,CDD$TOP.RICK.SPECIAL_DB -  
_$_ /PATH
```

Example 4

The following command converts an Oracle Rdb release 7.0 database to release 7.2. In addition, it reserves space in the database root file of the converted database for four .aij files. After-image journaling is not enabled at the time the Convert command is issued.

```
$RMU/CONVERT/CONFIRM/RESERVE=(AIJ=4)/COMMIT MF_PERSONNEL  
%RMU-I-RMUTXT_000, Executing RMU for Oracle Rdb V7.2-00  
Are you satisfied with your backup of DISK1:[TESTS]MF_PERSONNEL.RDB;1  
and your backup of any associated .aij files [N]? Y  
%RMU-I-LOGCONVRT, database root converted to current structure level  
%RMU-W-DOFULLBCK, full database backup should be done to ensure future recovery  
%RMU-S-CVTDBSUC, database DISK1:[TESTS]MF_PERSONNEL.RDB;1 successfully  
converted from version V7.0 to V7.2
```

Example 5

The following example shows how the contents of a batch file might look if you were to issue the RMU Convert command with the Confirm qualifier from a batch job.

```
$ RMU/CONVERT/COMMIT/CONFIRM USER1:[COLLECT.V71DB]MF_PERSONNEL  
Y  
Y
```

1.17 RMU Copy_Database Command

1.17 RMU Copy_Database Command

Permits you to copy a database.

Format

RMU/Copy_Database root-file-spec [storage-area-list]

Command Qualifiers

/[No]After_Journal[=file-spec]
/[No]Aij_Options=journal-opts-file
/[No]Cdd_Integrate
/[No]Checksum_Verification
/Close_Wait=n
/Directory=directory-spec
/[No]Duplicate
/Global_Buffers=global-buffer-options
/Local_Buffers=local-buffer-options
/Lock_Timeout=n
/[No]Log
/Nodes_Max=n
/[No]Online
/Open_Mode={Automatic|Manual}
/Option=file-spec

/Page_Buffers=n
/Path=cdd-path
/[No]Quiet_Point
/Root=file-spec
/Transaction_Mode=(mode-list)
/Users_Max=n

File or Area Qualifier

/Blocks_Per_Page=n
/Extension={Disable | Enable }
/File=file-spec
/Read_Only
/Read_Write
/Snapshots=(Allocation=n,File=file-spec)
/[No]Spams
/Thresholds=(n,n,n)

Defaults

See description
See description
Nocdd_Integrate
/Checksum_Verification
See description
None
/Noduplicate
Current value
Current value
See description
Current DCL verify value
Current value
/Noonline
Current value
None

n=33
Existing value
/Quiet_Point
None
/Transaction_Mode=Current
Current value

Defaults

None
Current value
None
Current value
Current value
None
Current value
None

1.17 RMU Copy_Database Command

Description

The RMU Copy_Database command allows you to modify certain area parameters when the copy operation is performed. All the files are processed simultaneously during the copy operation. The copy operation's performance is similar to that of the RMU Backup command. The RMU Copy_Database command eliminates the need for intermediate storage media.

Note

You must perform a full and complete Oracle RMU backup operation immediately after the Copy_Database operation completes to ensure that the database can be properly restored after a database failure or corruption.

Also note that if you do not specify either the After_Journal qualifier or the Aij_Options qualifier when you issue the RMU Copy_Database command, after-image journaling is disabled for the database copy and no .aij files are associated with the database copy.

Command Parameters

root-file-spec

The name of the database root file for the database you want to copy.

storage-area-list

The name of one or more storage areas whose parameters you are changing. The storage-area-list parameter is optional. Unless you are using the RMU Copy_Database command to modify the parameters of one or more storage areas, you should not specify any storage area names.

Command Qualifiers

After_Journal[=file-spec]

Noafter_Journal

Note

This qualifier is maintained for compatibility with versions of Oracle Rdb prior to Version 6.0. You might find it more useful to specify the Aij_Options qualifier, unless you are interested in creating an extensible .aij file only.

1.17 RMU Copy_Database Command

Specifies how Oracle RMU is to handle after-image journaling and .aij file creation, using the following rules:

- If you specify the `After_Journal` qualifier and provide a file specification, Oracle RMU enables journaling and creates a new extensible after-image journal (.aij) file for the database copy.
- If you specify the `After_Journal` qualifier but you do not provide a file specification, Oracle RMU enables after-image journaling and creates a new extensible .aij file for the database copy with the same name as, but a different version number from, the .aij file for the database being copied.
- If you specify the `Noafter_Journal` qualifier, Oracle RMU disables after-image journaling and does not create a new .aij file.
- If you do not specify an `After_Journal`, `Noafter_Journal`, `Aij_Options`, or `Noaij_Options` qualifier, Oracle RMU disables after-image journaling and does not create a new .aij file.

You can specify only one, or none, of the following after-image journal qualifiers in a single RMU `Copy_Database` command: `After_Journal`, `Noafter_Journal`, `Aij_Options`, or `Noaij_Options`.

You cannot use the `After_Journal` qualifier to create fixed-size .aij files; use the `Aij_Options` qualifier.

Aij_Options=journal-opts-file

Noaij_Options

Specifies how Oracle RMU is to handle after-image journaling and .aij file creation, using the following rules:

- If you specify the `Aij_Options` qualifier and provide a journal-opts-file, Oracle RMU enables journaling and creates the .aij file or files you specify for the database copy. If only one .aij file is created for the database copy, it will be an extensible .aij file. If two or more .aij files are created for the database copy, they will be fixed-size .aij files (as long as at least two .aij files are always available).
- If you specify the `Aij_Options` qualifier, but do not provide a journal-opts-file, Oracle RMU disables journaling and does not create any new .aij files.
- If you specify the `Noaij_Options` qualifier, Oracle RMU disables journaling and does not create any new .aij files.

1.17 RMU Copy_Database Command

- If you do not specify an `After_Journal`, `Noafter_Journal`, `Aij_Options`, or `Noaij_Options` qualifier, Oracle RMU disables after-image journaling and does not create a new `.aij` file.

You can only specify one, or none, of the following after-image journal qualifiers in a single Oracle RMU command: `After_Journal`, `Noafter_Journal`, `Aij_Options`, `Noaij_Options`.

See Section 1.61.1 for information on the format of a `journal-opts-file`.

Cdd_Integrate

Nocdd_Integrate

Integrates the metadata from the root (`.rdb`) file of the database copy into the data dictionary (assuming the data dictionary is installed on your system).

If you specify the `Nocdd_Integrate` qualifier, no integration occurs during the copy operation.

You might want to delay integration of the database metadata with the data dictionary until after the copy operation finishes successfully.

You can use the `Nocdd_Integrate` qualifier even if the `DICTIONARY IS REQUIRED` clause was used when the database being copied was defined.

The `Cdd_Integrate` qualifier integrates definitions *in one direction only*—from the database file to the dictionary. The `Cdd_Integrate` qualifier does *not* integrate definitions from the dictionary to the database file.

The `Nocdd_Integrate` qualifier is the default.

Checksum_Verification

Nochecksum_Verification

Requests that the page checksum be verified for each page copied. The default is to perform this verification.

The `Checksum_Verification` qualifier uses significant CPU resources but can provide an extra measure of confidence in the quality of the data being copied. For offline copy operations, the additional CPU cost of using the `Checksum_Verification` qualifier might not be justified unless you are experiencing or have experienced disk, HSC, or CI port hardware problems. One symptom of these problems is pages being logged to the corrupt page table (CPT).

For online copy operations, use of the `Checksum_Verification` qualifier offers an additional level of data security when the database employs disk striping or RAID (redundant arrays of inexpensive disks) technology. These technologies fragment data over several disk drives, and use of the `Checksum_Verification` qualifier permits Oracle RMU to detect the possibility that the data it is

1.17 RMU Copy_Database Command

reading from these disks has been only partially updated. If you use either of these technologies, you should use the `Checksum_Verification` qualifier.

Note, however, that if you specify the `Nochecksum` qualifier, and undetected corruptions exist in your database, the corruptions are included in the copied file. Such a corruption might be difficult to recover from, especially if it is not detected until weeks or months after the copy operation is performed.

Overall, Oracle Corporation recommends that you use the `Checksum_Verification` qualifier with all copy operations where integrity of the data is essential.

Close_Wait=*n*

Specifies a wait time of *n* minutes before Oracle RMU automatically closes the database. You must supply a value for *n*.

In order to use this qualifier, the `Open_Mode` qualifier on the `RMU Copy_Database` command line must be set to `Automatic`.

Directory=directory-spec

Specifies the default destination for the copied database files. Note that if you specify a file name or file extension, all copied files are given that file name or file extension. There is no default directory specification for this qualifier.

See the Usage Notes for information on how this qualifier interacts with the `Root`, `File`, and `Snapshot` qualifiers and for warnings regarding copying database files into a directory owned by a resource identifier.

If you do not specify this qualifier, Oracle RMU attempts to copy all the database files (unless they are qualified with the `Root`, `File`, or `Snapshot` qualifier) to their current location.

Duplicate

Noduplicate

Causes the `RMU Copy_Database` command to generate a new database with the same content, but with a different identity from that of the original database. For this reason, `.ajj` files cannot be interchanged between the original and the duplicate database. This qualifier creates copies of your databases that are expected to evolve independently in time. In this case, being able to exchange `.ajj` files might be a security breach, and a likely source of corruption.

A duplicate database has the same contents as the original database, but not the same identity. A database copied with the `Noduplicate` qualifier is an exact replica of the original database in every way and, therefore, `.ajj` files can be interchanged between the original and duplicate database.

1.17 RMU Copy_Database Command

The default is the Noduplicate qualifier.

Global_Buffers=global-buffer-options

Allows you to change the default global buffer parameters when you copy a database. The following options are available:

- **Disabled**
Use this option to disable global buffering for the copy of the original database.
- **Enabled**
Use this option to enable global buffering for the copy of the original database. You cannot specify both the Disabled and Enabled option in the same RMU Copy_Database command with the Global_Buffers qualifier.
- **Total=total-buffers**
Use this option to specify the number of buffers available for all users.
- **User_Limit=buffers-per-user**
Use this option to specify the maximum number of buffers available to each user.

If you do not specify a global buffers option, the database is copied with the values that are in effect for the database you are copying.

When you specify two or more options with the Global_Buffers qualifier, use a comma to separate each option and enclose the list of options in parentheses.

Local_Buffers=local-buffer-options

Allows you to change the default local buffer parameters when you copy a database. The following options are available:

- **Number=number-buffers**
Use this option to specify the number of local buffers that will be available for all users. You must specify a number between 2 and 32,767 for the number-buffers parameter.
- **Size=buffer-blocks**
Use this option to specify the size (specified in blocks) for each buffer. You must specify a number between 2 and 64 for the buffer-blocks parameter.
If you specify a value smaller than the size of the largest page defined, Oracle RMU automatically adjusts the size of the buffer to hold the largest page defined. For example, if you specify the Local_Buffers=Size=8 qualifier and the largest page size for the storage areas in your database is

1.17 RMU Copy_Database Command

64 blocks, Oracle RMU automatically interprets the `Local_Buffers=Size=8` qualifier as though it were a `Local_Buffers=Size=64` qualifier.

Take great care when selecting a buffer size; a poor choice causes performance to suffer greatly.

The value specified for the buffer-blocks parameter determines the number of blocks for each buffer, regardless of whether local buffering or global buffering is enabled for the database.

If you do not specify a `Local_Buffers` option, the database is copied with the values that are in effect for the database you are copying.

Lock_Timeout=n

Specifies a timeout interval or maximum time in seconds to wait for the quiet-point lock request when the operation is performed on line. When you specify the `Lock_Timeout=seconds` qualifier, you must specify the number of seconds to wait for the quiet-point lock. If the time limit expires, an error is signaled and the copy operation fails.

The default value for the `Lock_Timeout=n` qualifier is the minimum of the default set for the database at its creation, and the value of the logical name `RDM$BIND_LOCK_TIMEOUT_INTERVAL`.

When the `Lock_Timeout=seconds` qualifier is not specified, the copy operation waits indefinitely for the quiet-point lock during an online copy operation.

The `Lock_Timeout=seconds` qualifier is ignored for offline copy operations.

Log

Nolog

Specifies whether the processing of the command is reported to `SYS$OUTPUT`. Specify the `Log` qualifier to request log output and the `Nolog` qualifier to prevent it. If you specify neither, the default is the current setting of the `DCL verify` switch. (The `DCL SET VERIFY` command controls the `DCL verify` switch.)

Nodes_Max=n

Specifies a new value for the database maximum node count parameter for the database copy. The default is to leave the value unchanged.

Online

Noonline

Specifies that the copy database operation be performed while other users are attached to the database. The areas to be copied are locked for read-only access, so the operation is compatible with all but exclusive access. However, an online copy operation cannot be performed if `TRANSFER VIA MEMORY`,

1.17 RMU Copy_Database Command

also referred to as optimized page transfer, is enabled. (See the description of the SQL ALTER DATABASE statement in the *Oracle Rdb SQL Reference Manual* for information on optimized page transfer.)

The default is the Noonline qualifier.

Open_Mode=Automatic

Open_Mode=Manual

Allows you to change the mode for opening a database when you copy a database. When you specify the Open_Mode=Automatic qualifier, users can invoke the database copy immediately after it is copied. If you specify the Open_Mode=Manual qualifier, an RMU Open command must be used to open the database before users can invoke the database copy.

The Open_Mode qualifier also specifies the mode for closing a database. If you specify Open_Mode=Automatic, you can also use the Close_Wait qualifier to specify a time in minutes before the database is automatically closed.

If you do not specify the Open_Mode qualifier, the database is copied with the open mode that is in effect for the database being copied.

Option=file-spec

Specifies an options file containing storage area names, followed by the storage area qualifiers that you want applied to that storage area. Do *not* separate the storage area names with commas. Instead, put each storage area name on a separate line in the file. The storage area qualifiers that you can include in the options file are: Blocks_Per_Page, File, Snapshots, and Thresholds.

You can use the DCL line continuation character, a hyphen (-), or the comment character (!) in the options file. There is no default for this qualifier. Example 6 in the Examples section shows an options file and how to specify it on the Oracle RMU command line.

If the Option qualifier is specified, the storage-area-list parameter is ignored.

Page_Buffers=n

Specifies the number of buffers to be allocated for each database file to be copied. The number of buffers used is twice the number specified; half are used for reading the file and half for writing the copy. Values specified with the Page_Buffers qualifier can range from 1 to 5. The default value is 3. Larger values might improve performance, but they increase memory use.

Path=cdd-path

Specifies a data dictionary path into which the definitions of the database copy will be integrated. If you do not specify the Path qualifier, Oracle RMU

1.17 RMU Copy_Database Command

uses the CDD\$DEFAULT logical name value of the user who enters the RMU Copy_Database command.

If you specify a relative path name, Oracle Rdb appends the *relative* path name you enter to the CDD\$DEFAULT value. If the cdd-path parameter contains nonalphanumeric characters, you must enclose it within quotation marks (" ").

Oracle Rdb ignores the Path qualifier if you use the Nocdd_Integrate qualifier or if the data dictionary is not installed on your system.

Quiet_Point

Noquiet_Point

Allows you to specify that a database copy operation is to occur either immediately or when a quiet point for database activity occurs. A quiet point is defined as a point where no active update transactions are in progress in the database.

When you specify the Noquiet_Point qualifier, Oracle RMU proceeds with the copy operation as soon as the RMU Copy_Database command is issued, regardless of any update transaction activity in progress in the database. Because Oracle RMU must acquire concurrent-read locks on all physical and logical areas, the copy operation fails if there are any active transactions with exclusive locks on a storage area. However, once Oracle RMU has successfully acquired all concurrent-read storage area locks, it should not encounter any further lock conflicts. If a transaction that causes Oracle Rdb to request exclusive locks is started while the copy operation is proceeding, that transaction either waits or gets a lock conflict error, but the copy operation continues unaffected.

If you intend to use the Noquiet_Point qualifier with a copy procedure that previously specified the Quiet_Point qualifier (or did not specify either the Quiet_Point or Noquiet_Point qualifier), you should examine any applications that execute concurrently with the copy operation. You might need to modify your applications or your copy procedure to handle the lock conflicts that can occur when you specify the Noquiet_Point qualifier.

When you specify the Quiet_Point qualifier, the copy operation begins when a quiet point is reached. Other update transactions issued after the database copy operation begins are prevented from executing until after the root file for the database has been copied (copying of the database storage areas begins after the root file is copied).

The default is the Quiet_Point qualifier.

Root=file-spec

Requests that the database root file be copied to the specified location.

1.17 RMU Copy_Database Command

See the Usage Notes for information on how this qualifier interacts with the Directory, File, and Snapshot qualifiers.

Transaction_Mode=(mode-list)

Sets the allowable transaction modes for the database root file created by the copy operation. The mode-list can include one or more of the following transaction modes:

- All - Enables all transaction modes
- Current - Enables all transaction modes that are set for the source database. This is the default transaction mode.
- None - Disables all transaction modes
- [No]Batch_Update
- [No]Exclusive
- [No]Exclusive_Read
- [No]Exclusive_Write
- [No]Protected
- [No]Protected_Read
- [No]Protected_Write
- [No]Read_Only
- [No]Read_Write
- [No]Shared
- [No]Shared_Read
- [No]Shared_Write

Your copy operation must include the database root file. Otherwise, RMU returns the CONFLSWIT error when you issue an RMU Copy_Database command with the Transaction_Mode qualifier.

If you specify more than one transaction mode in the mode-list, enclose the list in parenthesis and separate the transaction modes from one another with a comma. Note the following:

- When you specify a negated transaction mode such as Noexclusive_Write, it indicates that exclusive write is not an allowable access mode for the copied database.

1.17 RMU Copy_Database Command

- If you specify the Shared, Exclusive, or Protected transaction mode, Oracle RMU assumes you are referring to both reading and writing in that transaction mode.
- No mode is enabled unless you add that mode to the list, or you use the All option to enable all transaction modes.
- You can list one transaction mode that enables or disables a particular mode followed by another that does the opposite. For example, `Transaction_Mode=(Noshared_Write, Shared)` is ambiguous because the first value disables Shared_Write access and the second value enables Shared_Write access. Oracle RMU resolves the ambiguity by first enabling the modes as specified in the modes-list and then disabling the modes as specified in the modes-list. The order of items in the list is irrelevant. In the example presented previously, Shared_Read is enabled and Shared_Write is disabled.

Users_Max=n

Specifies a new value for the database maximum user count parameter.

The default is to use the same value as is in effect for the database being copied.

File or Area Qualifiers

Blocks_Per_Page=n

Specifies a new page size for the storage area to which it is applied. You cannot decrease the page size of a storage area, and you cannot change the size of a storage area with a uniform page format.

You might want to increase the page size in storage areas containing hash indexes that are close to full. By increasing the page size in such a situation, you prevent the storage area from extending.

The `Blocks_Per_Page` qualifier is a positional qualifier.

Extension=Disable

Extension=Enable

Allows you to change the automatic file extension attribute for a storage area when you copy a database.

Use the `Extension=Disable` qualifier to disable automatic file extensions for a storage area.

Use the `Extension=Enable` qualifier to enable automatic file extensions for a storage area.

1.17 RMU Copy_Database Command

If you do not specify the `Extension=Disable` or the `Extension=Enable` qualifier, the storage areas are copied with the automatic file extension attributes that are in effect for the database being copied.

The `Extension` qualifier is a positional qualifier.

File=file-spec

Requests that the storage area to which this qualifier is applied be copied to the specified location.

See the Usage Notes for information on how this qualifier interacts with the `Root`, `Snapshot`, and `Directory` qualifiers and for warnings regarding copying database files into a directory owned by a resource identifier.

The `File` qualifier is a positional qualifier. This qualifier is not valid for single-file databases.

Read_Only

Use the `Read_Only` qualifier to change a read/write storage area or a write-once storage area to a read-only storage area.

If you do not specify the `Read_Only` or `Read_Write` qualifier, the storage areas are copied with the read/write attributes that are currently in effect for the database being copied.

This is a positional qualifier.

Read_Write

Use the `Read_Write` qualifier to change a read-only storage area or a write-once storage area to a read/write storage area.

If you do not specify the `Read_Only` or `Read_Write` qualifier, the storage areas are copied with the read/write attributes that are currently in effect for the database being copied.

This is a positional qualifier.

Snapshots=(Allocation=n,File=file-spec)

If you specify the `Allocation` parameter, specifies the snapshot file allocation size in *n* pages for a copied area. If you specify the `File` parameter, specifies a new snapshot file location for the copied storage area to which it is applied.

You can specify the `Allocation` parameter only, the `File` parameter only, or both parameters; however, if you specify the `Snapshots` qualifier, you must specify at least one parameter.

The `Snapshots` qualifier is a positional qualifier.

1.17 RMU Copy_Database Command

See the Usage Notes for information on how this qualifier interacts with the Root, File, and Directory qualifiers.

Spams

Nospams

Specifies whether to enable the creation of space area management (SPAM) pages or disable the creation of SPAM pages (Nospams) for specified storage areas. This qualifier is not permitted with a storage area that has a uniform page format.

When SPAM pages are disabled in a read/write storage area, the SPAM pages are initialized but they are not updated.

The Spams qualifier is a positional qualifier.

Thresholds=(n,n,n)

Specifies new SPAM thresholds for the storage area to which it is applied (for a mixed page format storage area). The thresholds of a storage area with a uniform page format cannot be changed.

See the *Oracle Rdb7 Guide to Database Performance and Tuning* for information on setting SPAM thresholds.

The Thresholds qualifier is a positional qualifier.

Usage Notes

- To use the RMU Copy_Database command for a database, you must have the RMU\$COPY privilege in the root file access control list (ACL) for the database to be copied or the OpenVMS SYSPRV or BYPASS privilege.
- When you copy a database into a directory owned by a resource identifier, the ACE for the directory is applied to the database root file ACL first, and then the Oracle RMU ACE is added. This method is employed to prevent database users from overriding OpenVMS file security. However, this can result in a database which you consider yours, but to which you have no Oracle RMU privileges to access. See the *Oracle Rdb Guide to Database Maintenance* for details.
- The RMU Copy_Database command provides four qualifiers, Directory, Root, File, and Snapshots, that allow you to specify the target for the copied files. The **target** can be just a directory, just a file name, or a directory and file name.

1.17 RMU Copy_Database Command

If you use all or some of these four qualifiers, apply them as follows:

- Use the Root qualifier to indicate the target for the copy of database root file.
- Use local application of the File qualifier to specify the target for the copy of one or more storage areas.
- Use local application of the Snapshots qualifier to specify the target for the copy of one or more snapshot files.
- Use the Directory qualifier to specify a default target directory. The default target directory is the directory to which all files not qualified with the Root, File, or Snapshot qualifier are copied. It is also the default directory for files qualified with the Root, File, or Snapshot qualifier if the target for these qualifiers does not include a directory specification.

Note the following when using these qualifiers:

- Global application of the File qualifier when the target specification includes a file name causes Oracle RMU to copy all of the storage areas to different versions of the same file name. This creates a database that is difficult to manage.
- Global application of the Snapshot qualifier when the target specification includes a file name causes Oracle RMU to copy all of the snapshot files to different versions of the same file name. This creates a database that is difficult to manage.
- Specifying a file name or extension with the Directory qualifier is permitted, but causes Oracle RMU to copy all of the files (except those specified with the File or Root qualifier) to different versions of the same file name. Again, this creates a database that is difficult to manage.

See Example 8.

- You cannot use the RMU Copy_Database command to copy a database to a remote system or to an NFS (Network File System) mounted file system. The RMU Copy_Database command allows you to create a copy of a database on the same node as the original database.
- You cannot disable extents of snapshot (.snp) files.
- The file and area qualifiers for the RMU Copy_Database command are positional qualifiers, and if placed randomly, could be ignored or produce unexpected results. See Section 1.2 for more information on positional qualifiers.

1.17 RMU Copy_Database Command

- There are no restrictions on the use of the Nospams qualifier with mixed page format storage areas, but the use of the Nospams qualifier typically causes severe performance degradation. The Nospams qualifier is only useful where updates are rare and batched, and access is primarily by database key (dbkey).

Examples

Example 1

The following command makes a duplicate copy of the mf_personnel database in the DISK1:[USER1] directory:

```
$ RMU/COPY_DATABASE MF_PERSONNEL /DIRECTORY=DISK1:[USER1]
```

Example 2

The following example shows a simple duplication of a database within a user's directory. In this instance, the duplicated database has the same content and identity as the original database. After-image journal files can be interchanged between the original and the duplicated database. Execute the RMU Dump command with the header qualifier to verify that the copied database is the same as the original database. Note that the creation date listed in the header for each database is the same.

```
$ RMU/COPY_DATABASE MF_PERSONNEL
```

Example 3

The following example shows a duplication of a database within a user's directory through the use of the Duplicate qualifier. In this instance, the duplicated database differs from the original database. It has the same content as the original database, but its identity is different. As a result, .aij files cannot be exchanged between the original database and the duplicate database. If you use the RMU Dump command with the header qualifier for each database, you see that the creation date for the copy and the original database is different.

```
$ RMU/COPY_DATABASE/DUPLICATE MF_PERSONNEL
```

Example 4

The following command copies the mf_personnel database from the DISK2:[USER2] directory to the DISK1:[USER1] directory. The Extension=Disable qualifier causes extents to be disabled for all the storage area (.rda) files in the DISK1:[USER1]mf_personnel database:

1.17 RMU Copy_Database Command

```
$ RMU/COPY_DATABASE/EXTENSION=DISABLE/DIRECTORY=DISK1:[USER1] -  
_$_$ DISK2:[USER2]MF_PERSONNEL
```

Example 5

The following command copies the mf_personnel database from the DISK2:[USER2] directory to the DISK2:[USER1] directory. Because the Extension=Disable qualifier is specified for only the EMPIDS_LOW and EMPIDS_MID storage areas, extents are disabled only for those two storage area (.rda) files in the DISK2:[USER1]mf_personnel database:

```
$ RMU/COPY_DATABASE/DIRECTORY=DISK2:[USER1] DISK2:[USER2]MF_PERSONNEL -  
_$_$ EMPIDS_LOW/EXTENSION=DISABLE,EMPIDS_MID/EXTENSION=DISABLE
```

Example 6

The following command uses an options file to specify that the storage area files and snapshot (.snp) files be copied to different disks. Note that storage area .snp files are located on different disks from one another and from their associated storage area (.rda) files; this is recommended for optimal performance. (This example assumes that the disks specified for each storage area file in options_file.opt are different from those where the storage area files currently reside.)

```
$ RMU/COPY_DATABASE/OPTIONS=OPTIONS_FILE.OPT MF_PERSONNEL
```

The options file appears as:

```
$ TYPE OPTIONS_FILE.OPT  
EMPIDS_LOW /FILE=DISK1:[CORPORATE.PERSONNEL]EMPIDS_LOW.RDA -  
/SNAPSHOT=(FILE=DISK2:[CORPORATE.PERSONNEL]EMPIDS_LOW.SNP)  
EMPIDS_MID /FILE=DISK3:[CORPORATE.PERSONNEL]EMPIDS_MID.RDA -  
/SNAPSHOT=(FILE=DISK4:[CORPORATE.PERSONNEL]EMPIDS_MID.SNP)  
EMPIDS_OVER /FILE=DISK5:[CORPORATE.PERSONNEL]EMPIDS_OVER.RDA -  
/SNAPSHOT=(FILE=DISK6:[CORPORATE.PERSONNEL]EMPIDS_OVER.SNP)  
DEPARTMENTS /FILE=DISK7:[CORPORATE.PERSONNEL]DEPARTMENTS.RDA -  
/SNAPSHOT=(FILE=DISK8:[CORPORATE.PERSONNEL]DEPARTMENTS.SNP)  
SALARY_HISTORY /FILE=DISK9:[CORPORATE.PERSONNEL]SALARY_HISTORY.RDA -  
/SNAPSHOT=(FILE=DISK10:[CORPORATE.PERSONNEL]SALARY_HISTORY.SNP)  
JOBS /FILE=DISK7:[CORPORATE.PERSONNEL]JOBS.RDA -  
/SNAPSHOT=(FILE=DISK8:[CORPORATE.PERSONNEL]JOBS.SNP)  
EMP_INFO /FILE=DISK9:[CORPORATE.PERSONNEL]EMP_INFO.RDA -  
/SNAPSHOT=(FILE=DISK10:[CORPORATE.PERSONNEL]EMP_INFO.SNP)  
RESUME_LISTS /FILE=DISK11:[CORPORATE.PERSONNEL]RESUME_LISTS.RDA -  
/SNAPSHOT=(FILE=DISK12:[CORPORATE.PERSONNEL]RESUME_LISTS.SNP)
```

1.17 RMU Copy_Database Command

```
RESUMES /FILE=DISK9:[CORPORATE.PERSONNEL]RESUMES.RDA -  
/SNAPSHOT=(FILE=DISK10:[CORPORATE.PERSONNEL]RESUMES.SNP)
```

1.17 RMU Copy_Database Command

Example 7

The following example copies the mf_personnel database from one directory to another. In addition, by specifying the Aij_Options qualifier to add after-image journal files, it enables fixed-size journaling in the database copy and sets several of the journal options as shown in the aij_journal_options.opt file.

```
$ RMU/COPY_DATABASE MF_PERSONNEL/DIRECTORY=DB1:[ROOT] -  
/AIJ_OPTIONS=AIJ_JOURNAL_OPTIONS.OPT  
  
$ TYPE AIJ_JOURNAL_OPTIONS.OPT  
  
JOURNAL IS ENABLED      -  
RESERVE 2               -  
ALLOCATION IS 1024      -  
BACKUPS ARE MANUAL     -  
OVERWRITE IS DISABLED  -  
SHUTDOWN_TIMEOUT IS 120 -  
CACHE IS DISABLED  
  
ADD MF_PERS1 FILE DB2:[AIJONE]MF_PERS1.AIJ  
ADD MF_PERS2 FILE DB3:[AIJTWO]MF_PERS2.AIJ
```

Example 8

The following example demonstrates the use of the Directory, File, and Root qualifiers. In this example:

- The default directory is specified as DISK2:[DIR].
- The target directory and file name for the database root file is specified with the Root qualifier. The target directory specified with the Root qualifier overrides the default directory specified with the Directory qualifier. Thus, Oracle RMU copies the database root to DISK3:[ROOT] and names it COPYRDB.RDB.
- The target directory for the EMPIDS_MID storage area is DISK4:[FILE]. Oracle RMU copies EMPIDS_MID to DISK4:[FILE].
- The target file name for the EMPIDS_LOW storage area is EMPIDS. Thus, Oracle RMU copies the EMPIDS_LOW storage area to the DISK2 default directory (specified with the Directory qualifier), and names the file EMPIDS.RDA.
- The target for the EMPIDS_LOW snapshot file is DISK5:[SNAP]EMPIDS.SNP. Thus, Oracle RMU copies the EMPIDS_LOW snapshot file to DISK5:[SNAP]EMPIDS.SNP.

1.17 RMU Copy_Database Command

- All the other storage area files and snapshot files in the mf_personnel database are copied to DISK2:[DIR]; the file names for these storage areas remain unchanged.

```
$ RMU/COPY_DATABASE DISK1:[DB]MF_PERSONNEL.RDB -
_ $ /DIRECTORY=DISK2:[DIR] -
_ $ /ROOT=DISK3:[ROOT]COPYRDB.RDB -
_ $ EMPIDS_MID/FILE=DISK4:[FILE], -
_ $ EMPIDS_LOW/FILE=EMPIDS -
_ $ /SNAPSHOT=(FILE=DISK5:[SNAP]EMPIDS.SNP)
```

Example 9

The following example demonstrates how to disallow exclusive mode for a copied database. It then shows the error messages returned when a user attempts to access the copied database using the disallowed mode:

```
$ RMU/COPY_DATABASE/TRANSACTION_MODE=NOEXCLUSIVE/DIRECTORY=[.COPY] -
_ $ MF_PERSONNEL.RDB
%RMU-W-DOFULLBCK, full database backup should be done to ensure future
recovery
$ SQL
SQL> ATTACH 'FILENAME mf_personnel.rdb';
SQL> SET TRANSACTION READ WRITE RESERVING EMPLOYEES FOR EXCLUSIVE WRITE;
%RDB-E-BAD_TPB_CONTENT, invalid transaction parameters in the
transaction parameter block (TPB)
-RDMS-E-INVTRANOPT, the transaction option "EXCLUSIVE WRITE" is not
allowed
SQL>
```

1.18 RMU Delete Optimizer_Statistics Command

1.18 RMU Delete Optimizer_Statistics Command

Deletes records from the RDB\$WORKLOAD system table.

Format

RMU/Delete Optimizer_Statistics root-file-spec

<u>Command Qualifiers</u>	<u>Defaults</u>
/Column_Group=(column-list)	See description
/[No]Log[=file-name]	See description
/Tables=(table-list)	None - Required Qualifier

Description

When you enable and collect workload statistics, the system table, RDB\$WORKLOAD, is created and populated. (See Section 1.15 for details.) If you are knowledgeable about the data in your database, or if workload statistics were gathered for queries that are no longer in use, you might decide that you no longer want Oracle RMU to collect statistics for particular column groups. The RMU Delete Optimizer_Statistics gives you the ability to selectively delete records for column groups in the RDB\$WORKLOAD system table.

When you use the RMU Delete Optimizer_Statistics command, both the optimizer statistics themselves and the reference to the column duplicity factor and the null factor are deleted from the RDB\$WORKLOAD system table.

If you issue an RMU Collect Optimizer_Statistics command after having issued an RMU Delete Optimizer_Statistics command, statistics for the specified column group are not collected.

Command Parameters

root-file-spec

Specifies the database from which optimizer statistics are to be deleted. The default file type is .rdb.

1.18 RMU Delete Optimizer_Statistics Command

Command Qualifiers

Column_Group=(column-list)

Specifies a list of columns that comprise a single column group. The columns specified must be a valid column group for a table specified with the Tables=(table-list) qualifier. (Use the RMU Show Optimizer_Statistics command to display a valid column groups.) When you specify the Column_Group qualifier, the entire record in the RDB\$WORKLOAD system table that holds data for the specified column group is deleted. Therefore, the next time you issue the RMU Collect Optimizer_Statistics command, statistics for the specified column-group are not collected.

Log

Nolog

Log=file-name

Specifies whether the statistics deleted from the RDB\$WORKLOAD system table are to be logged. Specify the Log qualifier to have the information displayed to SYS\$OUTPUT. Specify the Log=file-spec qualifier to have the information written to a file. Specify the Nolog qualifier to prevent display of the information. If you do not specify any variation of the Log qualifier, the default is the current setting of the DCL verify switch. (The DCL SET VERIFY command controls the DCL verify switch.)

Tables=(table-list)

Specifies the table or tables for which column group entries are to be deleted, as follows:

- If you specify the Tables=(table-list) qualifier, but do not specify the Column_Group qualifier, then all column group entries for the listed tables are deleted from the RDB\$WORKLOAD system table.
- If you specify the Tables=(table-list) qualifier, and you specify the Column_Group=(column-list) qualifier, then the workload statistics entries for the specified tables that have exactly the specified column group are deleted from the RDB\$WORKLOAD system table.
- If you use an asterisk (*) with the Tables qualifier (Tables=*), all tables registered in the RDB\$WORKLOAD table are deleted. This allows the RDB\$WORKLOAD table to be purged.

If you issue an RMU Collect Optimizer_Statistics command after you have deleted a workload column group from the RDB\$WORKLOAD system table, those statistics are no longer collected.

1.18 RMU Delete Optimizer_Statistics Command

The Tables=(table-list) qualifier is a required qualifier; you cannot issue an RMU Delete Optimizer_Statistics command without the Tables=(table-list) qualifier.

Usage Notes

- To use the RMU Delete Optimizer_Statistics command for a database, you must have the RMU\$ANALYZE privilege in the root file access control list (ACL) for the database or the OpenVMS SYSPRV or BYPASS privilege.
- Cardinality statistics are automatically maintained by Oracle Rdb. Physical storage and workload statistics are only collected when you issue an RMU Collect Optimizer_Statistics command. To get information about the usage of physical storage and workload statistics for a given query, define the RDMS\$DEBUG_FLAGS logical name to be "O". For example:

```
$ DEFINE RDMS$DEBUG_FLAGS "O"
```

When you execute a query, if workload and physical statistics have been used in optimizing the query, you will see a line such as the following in the command output:

```
~0: Workload and Physical statistics used
```

- Oracle Corporation recommends that you execute an RMU Show Optimizer_Statistics command with the Output qualifier prior to executing an RMU Delete Optimizer_Statistics command. If you accidentally delete statistics, you can replace them by issuing an RMU Insert Optimizer_Statistics command and specifying the statistical values contained in the output file.

Examples

Example 1

The following example issues commands to do the following:

1. Display optimizer statistics for the EMPLOYEES and JOB_HISTORY tables and their indexes
2. Delete the entries for the column group (EMPLOYEE_ID, JOB_CODE, JOB_START, JOB_END, DEPARTMENT_CODE, SUPERVISOR_ID) in JOB_HISTORY

1.18 RMU Delete Optimizer_Statistics Command

```
$ RMU/SHOW OPTIMIZER_STATISTICS MF_PERSONNEL.RDB -
_$$ /TABLES=(EMPLOYEES, JOB_HISTORY)/STATISTICS=(WORKLOAD)
-----
Optimizer Statistics for table : EMPLOYEES

Workload Column group :      EMPLOYEE_ID
Duplicity factor      : 1.0000000
Null factor           : 0.0000000
First created time    : 3-JUL-1996 10:37:36.43
Last collected time   : 3-JUL-1996 10:46:10.73

Workload Column group : LAST_NAME,      FIRST_NAME,      MIDDLE_INITIAL,
ADDRESS_DATA_1, ADDRESS_DATA_2, CITY,      STATE,      POSTAL_CODE,      SEX,
BIRTHDAY,      STATUS_CODE
Duplicity factor      : 1.5625000
Null factor           : 0.3600000
First created time    : 3-JUL-1996 10:37:36.43
Last collected time   : 3-JUL-1996 10:46:10.74
-----
Optimizer Statistics for table : JOB_HISTORY

Workload Column group :      EMPLOYEE_ID
Duplicity factor      : 2.7400000
Null factor           : 0.0000000
First created time    : 3-JUL-1996 10:37:36.43
Last collected time   : 3-JUL-1996 10:54:09.62

Workload Column group : EMPLOYEE_ID,      JOB_CODE,      JOB_START,
JOB_END,      DEPARTMENT_CODE,      SUPERVISOR_ID
Duplicity factor      : 1.5930233
Null factor           : 0.3649635
First created time    : 3-JUL-1996 10:57:47.65
Last collected time   : 3-JUL-1996 10:57:47.65
$ !
$ ! Delete one of the entries for JOB_HISTORY
$ !
$ RMU/DELETE OPTIMIZER_STATISTICS MF_PERSONNEL.RDB/TABLE=(JOB_HISTORY) -
_$$ /COLUMN_GROUP=(EMPLOYEE_ID, JOB_CODE, JOB_START, JOB_END, -
_$$ DEPARTMENT_CODE, SUPERVISOR_ID)/LOG
Changing RDB$SYSTEM area to READ_WRITE.
Workload column group deleted for JOB_HISTORY :      EMPLOYEE_ID,
JOB_CODE,      JOB_START,      JOB_END,      DEPARTMENT_CODE,
SUPERVISOR_ID
```

1.19 RMU Dump Command

1.19 RMU Dump Command

Displays or writes to a specified output file the contents of database, storage area (.rda), and snapshot (.snp) files, including root information.

Format

RMU/Dump root-file-spec

File Qualifiers

/[No]Areas [= storage-area-list]
/End=integer
/[No]Header[=detail-opt, type-opts]
/[No]Lareas [= logical-area-list]
/Option=(Normal | Full | Debug)
/Output = file-name
/Restore_Options=file-name
/[No]Snapshots [= storage-area-list]
/Spams_Only
/Start=integer
/State=Blocked
/[No]Users

Defaults

/Noareas
See description
See description
/Nolareas
/Option=Normal
/Output=SYS\$OUTPUT
None
/Nosnapshots
See description
See description
See description
/Nousers

Note

The Start and End qualifiers apply only when the Areas, Lareas, Snapshots, or Spams_Only qualifier is specified.

Description

Use this command to examine the contents of your database root (.rdb), storage area (.rda), and snapshot (.snp) files, to display current settings for database definition options, and to display a list of active database users. The list of database users is maintained clusterwide in a VMScluster environment.

You can display the contents of all pages in any data storage area of the database or display the contents of just those pages in which rows and indexes for a specific table are stored.

See the chapter that explains the internal database page format in the *Oracle Rdb Guide to Database Maintenance* for tutorial information.

1.19 RMU Dump Command

Depending on your selection of qualifiers, the RMU Dump command can list:

- A formatted display of any number of pages in the storage area of the database.
- A formatted display of any number of pages in a uniform logical area of the database.
- A formatted display of any number of pages in the snapshot area of the database.
- Header information. (This is listed by default if no qualifiers are specified.)
- Current users of the database.

Command Parameters

root-file-spec

A file specification for the database root file whose root file header information, user information, storage area file pages, or snapshot area file pages you want to display.

File Qualifiers

Areas [=storage-area-list]

Noareas

Specifies a display that consists of storage area pages. You can specify storage areas by name or by the area's ID number.

If you specify more than one storage area, separate the storage area names or ID numbers in the storage area list with a comma, and enclose the list within parentheses.

You can also specify the `Areas=*` qualifier to display all storage areas. If you do not specify the `Areas` qualifier, none of the storage areas are displayed.

You can use the `Start` and `End` qualifiers to display a range of storage area pages.

The `Areas` qualifier can be used with indirect file references. See Section 1.3 for more information.

End=integer

Specifies the highest-numbered area or snapshot page to include in the display. The default is the last page.

If you also use the `Lareas` qualifier, note that the `Start` and `End` qualifiers specify a page range relative to the logical area, not a specific storage area page number.

1.19 RMU Dump Command

Header[=(detail-opt, type-opts)]

Noheader

Indicates whether to include the database header in the output. Specify the Header qualifier to include all database header information in the output. Specify the Noheader qualifier to suppress the database header listing. Specify the Header=(detail-opt, type-opts) qualifier to limit the output from the header to specific items of interest. Use the detail-opt options (Brief or Detail) to limit the amount of output. Use the type-opt options to limit the output to specific types of information.

Table 1–8 summarizes the Header options and the effects of specifying each option.

Table 1–8 RMU Dump Command Header Options

Option	Effect
All	Generates the full output of all the header information. If you specify this option and other Header options, the other options are ignored. This is the default option.
Areas	Output displays information about active storage areas and snapshot areas.
Backup	Output displays information about backup and recovery.
Brief	Generates a summary of the requested database root file information.
Buffers	Output displays information about database buffers.
Corrupt_Page	Output displays the Corrupt Page Table (CPT).
Detail	Generates a complete report of the requested database root file information. This is the default.
Fast_Commit	Output displays information about whether fast commit is enabled or disabled, whether commit to AIJ optimization is enabled or disabled, the AIJ checkpointing intervals, and the transaction interval.

(continued on next page)

1.19 RMU Dump Command

Table 1–8 (Cont.) RMU Dump Command Header Options

Option	Effect
Hot_Standby	Output displays information regarding hot standby databases.
Locking	Output displays information about database locking, such as whether or not adjustable record locking, carry-over lock optimization, and lock tree partitioning are enabled or disabled, and fanout factors.
Journaling	Output displays information about RUJ and AIJ journaling.
Nodes	Output displays names of nodes that are accessing the specified database.
Parameters	Output displays basic root file header information.
Root_Record	Output describes the Oracle Rdb specific section of the database root. This includes backup, restore, verify, and alter timestamps, as well as flags that indicate that no such operation has been performed. The bootstrap DBKEY is used to locate the RDB\$DATABASE row for this database, and then the other system tables. If an alternate bootstrap DBKEY exists, then this database has been converted using RMU Convert Nocommit command. In this case, the current metadata version is displayed.
Row_Caches	Output displays information about row caches.
Security_Audit	Output displays information about security auditing.
Sequence_Numbers	Output displays database sequence numbers.
Users	Output displays information about active database users.

If you specify both the Detail option and the Brief option, Detail takes precedence. If you specify the All option and other detail-opt options, the All option takes precedence. If you specify the Brief option or the Detail option only, the default for the type-opt is All. If you specify type-opt options, but do not specify a detail-opt option, the default for the detail-opt is Detail.

1.19 RMU Dump Command

If you specify more than one option, separate the options with commas and enclose the list within parentheses.

See the Usage Notes section for information on understanding the derived values found in the database header.

The Header=All and Header=Root_Record qualifiers output information on the use of the RMU Alter command on the specified database. For example, you see the following line in the output if you have never used the RMU Alter command on the database:

```
Database has never been altered
```

Do not confuse this with alterations made by SQL ALTER statements. Information about alterations made with the SQL ALTER statement is not included in the output from the RMU Dump command.

If you specify the Areas, Lareas, or Snapshots qualifier, the Noheader qualifier is the default. Otherwise, Header=(All, Detail) is the default.

It is invalid to specify the Header=Root_Record and the Option=Debug qualifiers in the same Oracle RMU command line.

See the *Oracle Rdb7 and Oracle CODASYL DBMS: Guide to Hot Standby Databases* manual for information about the “Hot Standby” references in the database header.

For complete information on the contents of the database header, see the *Oracle Rdb Guide to Database Maintenance*.

Lareas[=logical-area-list]

Nolareas

Specifies a display that consists of storage area pages allocated to a logical area or areas. In a single-file database, each table in the database is stored in its own logical area.

You cannot use the Lareas qualifier with logical areas that are stored in storage areas that have a mixed page format.

If you specify more than one logical area name, separate the storage area names in the logical area list with a comma, and enclose the list within parentheses.

You can also specify the Lareas=* qualifier to display all logical areas that have a uniform page format.

The default is the Nolareas qualifier.

The Lareas qualifier can be used with indirect file references. See Section 1.3 for more information.

1.19 RMU Dump Command

Option=type

Specifies the type of information and level of detail the output will include.

Three types of output are available:

- Normal
The output includes summary information. This is the default.
- Full
In addition to the Normal information, the output includes more detailed information.
- Debug
In addition to Normal and Full information, the output includes internal information about the data. In general, use the Debug option for diagnostic support purposes.

Output=file-name

Specifies the name of the file where output is to be sent. The default is SYS\$OUTPUT. The default output file type is .lis, if you specify a file name.

Restore_Options=file-name

Generates an options file designed to be used with the Options qualifier of the RMU Restore command.

The Restore_Options file is created by reading the database root file. Therefore, there is no guarantee that this options file will work with all backup files you attempt to restore with a Restore operation. For example, if areas have been added or deleted from the database since the backup file was created, there will be a mismatch between the Restore_Options file and the backup file. Similarly if the backup file was created by a backup by-area operation, the Restore_Options file may refer to areas that are not in the backup file.

By default a Restore_Options file is not created. If you specify the Restore_Options qualifier and a file, but not a file extension, Oracle RMU uses an extension of .opt by default.

Snapshots[=storage-area-list]

Nosnapshots

Specifies a display that consists of snapshot file pages. The RMU Dump command does not display snapshot pages if you omit the Snapshots qualifier or if you specify the Nosnapshots qualifier.

1.19 RMU Dump Command

In a single-file database, there is only one snapshot file. In a multfile database, each storage area has a corresponding snapshot file. Note that this parameter specifies the storage area name, not the snapshot file name. If you specify more than one storage area name, separate the storage area names with commas, and enclose the storage-area-list within parentheses. If you specify the Snapshots qualifier without a storage area name, information is displayed for all snapshot files.

You can use the Start and End qualifiers to display a range of snapshot file pages.

The default is the Nosnapshots qualifier.

The Snapshots qualifier can be used with indirect file references. See Section 1.3 for more information.

Spams_Only

Allows you to dump only the space area management (SPAM) pages in the selected areas and page range.

A common usage for the RMU Dump command is to track down problems with storage allocation and record placement. When this qualifier is used, the SPAM pages are dumped, allowing you to locate the individual data pages that you want to examine.

There is no negated form for this qualifier, and, if it is omitted, all the selected pages are dumped.

The Start and End qualifiers can be used with the Spams_Only qualifier.

Start=integer

Specifies the lowest-numbered area or snapshot page to include in the display. The default is the first page; that is, the Start=1 qualifier.

If you also use the Lareas qualifier, note that the Start and End qualifiers specify a page range relative to the logical area, not a specific storage area page number.

State=Blocked

Specifies a list of all unresolved distributed transactions in the blocked database. A **blocked database** is a database that is not committed or rolled back and is involved in an unresolved distributed transaction. The State=Blocked qualifier displays the following information about each transaction:

- Process identification (PID)
- Stream identification

1.19 RMU Dump Command

- Monitor identification
- Transaction identification
- Name of the recovery journal
- Transaction sequence number (TSN)
- Distributed transaction identifier (TID)
- Name of the node on which the failure occurred
- Name of the node initiating the transaction (parent node)

You can use the `State=Blocked` qualifier only with the `Users` qualifier. For information on resolving unresolved transactions with the `RMU Dump` command, see the *Oracle Rdb7 Guide to Distributed Transactions*.

Users

Nousers

Lists information about the current users of the database, including all users in a VMScluster environment. Oracle RMU does not consider a process that is running the Performance Monitor (with the `RMU Show Statistics` command or through the Windowing interface) to be a database user.

The default is `Nousers`.

Usage Notes

- To use the `RMU Dump` command with the `Areas` qualifier or the `Lareas` qualifier or the `Snapshots` qualifier for a database, you must have the `RMU$DUMP` privilege in the root file access control list (ACL) for the database or the OpenVMS `SYSPRV` or `BYPASS` privilege.

To use the `RMU Dump` command with the `Header` qualifier for a database, you must have the `RMU$DUMP`, `RMU$BACKUP`, or `RMU$OPEN` privileges in the root file access control list (ACL) for the database, or the OpenVMS `SYSPRV` or `BYPASS` privilege.

To use the `RMU Dump` command with the `Users` qualifier, you must have the `RMU$DUMP`, `RMU$BACKUP`, or `RMU$OPEN` privileges in the root file access control list (ACL) for the database or the OpenVMS `WORLD` privilege.

- The `Spams_Only` qualifier conflicts with the `Lareas` and `Snapshots` qualifiers; an error is generated if you specify the `Spams_Only` qualifier with either of the other qualifiers.

1.19 RMU Dump Command

- The Header=All and Header=Buffers qualifiers provide two derived values to provide an *estimated* size of the global section. These appear in the dump file as:

```
Derived Data...
- Global section size
  With global buffers disabled is 43451 bytes
  With global buffers enabled is 941901 bytes
```

The first value (With global buffers disabled) indicates the approximate size of the global section when local buffers are being used. The second value (With global buffers enabled) indicates the approximate size of the global section if you were to enable global buffers.

You can use these values to determine approximately how much bigger the global section becomes if you enable global buffers. This allows you to determine, without having to take the database off line, how much larger to make the VIRTUALPAGECNT and GBLPAGES SYSGEN parameters to accommodate the larger global section.

However, note that you must take the database off line if you decide to enable global buffers and you must shut down and reboot the system to change the SYSGEN parameters. It is recommended that you run AUTOGEN after you change SYSGEN parameters.

Also note that these changes may require you to change the MONITOR account quotas as well to ensure the paging file quota is adequate.

Examples

Example 1

The following example displays the header information for the mf_personnel database on the terminal screen:

```
$ RMU/DUMP MF_PERSONNEL
```

Example 2

The following example generates a list of unresolved transactions for the mf_personnel database:

```
$ RMU/DUMP/USERS/STATE=BLOCKED MF_PERSONNEL
```

Example 3

1.19 RMU Dump Command

The following example shows the command you might use to view the SPAM pages associated with the area EMPIDS_LOW:

```
$ RMU/DUMP/NOHEADER/AREAS=(EMPIDS_LOW)/SPAMS_ONLY -  
_$ MF_PERSONNEL/OUTPUT=DUMP.LIS
```

1.19 RMU Dump Command

Example 4

The following example demonstrates the use of the `Restore_Options` qualifier. The first command performs a dump operation on the `mf_personnel` database and creates a `Restore_Options` file. The second command shows a portion of the contents of the options file. The last command demonstrates the use of the options file with the RMU Restore command.

```
$ RMU/DUMP MF_PERSONNEL.RDB /RESTORE_OPTIONS=MF_PERS.OPT -
_ $ /OUTPUT=DUMP.LIS
$ TYPE MF_PERS.OPT
! Options file for database USER1:[DB]MF_PERSONNEL.RDB;1
! Created 19-JUL-1995 14:55:17.80
! Created by DUMP command

RDB$SYSTEM -
    /file=USER2:[STO]MF_PERS_DEFAULT.RDA;1 -
    /extension=ENABLED -
    /read_write -
    /spams -
    /snapshot=(allocation=100, -
                file=USER2:[SNP]MF_PERS_DEFAULT.SNP;1)

DEPARTMENTS -
    /file=USER3:[STO]DEPARTMENTS.RDA;1 -
    /blocks_per_page=2 -
    /extension=ENABLED -
    /read_write -
    /spams -
    /thresholds=(70,85,95) -
    /snapshot=(allocation=100, -
                file=USER3:[SNP]DEPARTMENTS.SNP;1)

.
.
.
$ RMU/RESTORE MF_PERSONNEL.RBF/OPTIONS=MF_PERS.OPT
```

Example 5

The following command generates a detailed display of backup, recovery, RUJ, and AIJ information for the `mf_personnel` database.

```
$ RMU/DUMP/HEADER=(BACKUP,JOURNALING) MF_PERSONNEL.RDB
```

See the *Oracle Rdb Guide to Database Maintenance* and the *Oracle Rdb7 Guide to Distributed Transactions* for more examples showing the RMU Dump command and the output.

1.20 RMU Dump After_Journal Command

1.20 RMU Dump After_Journal Command

Displays an after-image journal (.aij) file, a backed up .aij file (.aij if the backup is on disk, .aij_rbf if the .aij file was backed up to tape), or an optimized after-image journal (.oaij) file in ASCII format. Use this command to examine the contents of your .aij, .aij_rbf, or .oaij file. Whenever the term .aij file is used in this RMU Dump After_Journal command description, it refers to .oaij and .aij_rbf files, as well as .aij files.

An .aij file contains header information and data blocks. Header information describes the data blocks, which contain copies of data stored in the database file.

Format

RMU/Dump/After_Journal aij-file-name

File Qualifiers

/Active_IO=max-reads
/Area=integer
/[No]Data
/Encrypt={({Value=|Name=}|[,Algorithm=])
/End=integer
/First=(select-list)
/Format={Old_File|New-Tape}
/Label=(label-name-list)
/Larea=integer
/Last=(select-list)
/Librarian[=options]
/Line=integer
/[No]Media_Loader
/Only=(select-list)

/Option={Statistics|Nostatistics}
/Output=file-name
/Page=integer
/Prompt={Automatic|Operator|Client}
/No]Rewind
/Start=integer
/State=Prepared

Defaults

/Active_IO=3
None
/Data
See description
See description
See description
Format=Old_File
See description
None
See description
None
None
See description
See description

Option=Statistics
/Output=SYS\$OUTPUT
None
See description
Norewind
See description
See description

1.20 RMU Dump After_Journal Command

Description

The RMU Dump After_Journal command specifies an .ajj file, not a database file, as its parameter, and is a separate command from the RMU Dump command used to display database areas and header information.

The .ajj file is in binary format. This command translates the binary file into an ASCII display format.

The RMU Dump After_Journal command always includes the header of the .ajj file in the display. You can use the Nodata qualifier to exclude data blocks from the display entirely, or you can use the Start and End qualifiers to restrict the data block display to a specific series of blocks. If you do not specify any of these qualifiers, Oracle RMU includes all data blocks.

Command Parameters

ajj-file-name

The .ajj file you want to display. The default file type is .ajj. For .oajj files, you must specify the file type of .oajj.

File Qualifiers

Active_IO=max-reads

Specifies the maximum number of read operations from a backup device that the RMU Dump After_Journal command will attempt simultaneously. This is not the maximum number of read operations in progress; that value is the product of active system I/O operations.

The value of the Active_IO qualifier can range from 1 to 5. The default value is 3. Values larger than 3 can improve performance with some tape drives.

Area=integer

Identifies a physical database storage area by number. Dump output is limited to the specified area. The minimum value is 1.

Data

Nodata

Specifies whether you want to display data blocks of the .ajj file, or just the .ajj file header.

The Data qualifier is the default. It causes the display of the .ajj file data blocks (in addition to the file header) in an ASCII display format.

The Nodata qualifier limits the display to the record headers of the .ajj file.

1.20 RMU Dump After_Journal Command

Encrypt={Value= | Name=}[,Algorithm=]

The Encrypt qualifier decrypts the file of an after-image journal backup.

Specify a key value as a string or the name of a predefined key. If no algorithm name is specified the default is DESCBC. For details on the Value, Name and Algorithm parameters type `HELP ENCRYPT` at the OpenVMS prompt.

This feature requires the OpenVMS Encrypt product to be installed and licensed on your system.

This feature only works for a newer format backup file which has been created using the `Format=New_Tape` qualifier. You must specify the `Format=New_Tape` qualifier with this command if you use the Encrypt qualifier.

End=integer

Specifies the number of the last data block that you want to display. The default integer is the number of the last data block in the file. If you do not use the End qualifier, Oracle RMU displays the entire .ajj file.

First=(select-list)

Allows you to specify where you want the dump output to begin. (See the `Last=(select-list)` qualifier for the end of the range.) If you specify more than one keyword in the select-list, separate the keywords with commas and enclose the list in parentheses. If you specify multiple items in the select list, the first occurrence is the one that will activate Oracle RMU. For example, if you specify `First=(Block=100,TSN=0:52)`, the dump will start when either block 100 or TSN 52 is encountered.

The First and Last qualifiers are optional. You can specify both, either, or neither of them. The keywords specified for the First qualifier can differ from the keywords specified for the Last qualifier.

The select-list of the First qualifier consists of a list of one or more of the following keywords:

- **BLOCK=block-number**
Specifies the first block in the AIJ journal.
- **RECORD=record-number**
Specifies the first record in the AIJ journal. This is the same as the existing Start qualifier, which is still supported but obsolete.
- **TID=tid**
Specifies the first TID in the AIJ journal.
- **TIME=date_time**

1.20 RMU Dump After_Journal Command

Specifies the first date and time in the AIJ journal, using absolute or delta date-time format.

- **TSN=tsn**

Specifies the first TSN in the AIJ journal, using the standard [n:]m TSN format.

By default, the entire .aij file is dumped.

Format=Old_Rms

Format=New_Tape

Synonymous with **Format=Old_File** and **Format=New_Tape** qualifiers. See the description of those qualifiers.

Format=Old_File

Format=New_Tape

Specifies whether the backup or optimized .aij file was written in the old (disk-optimized) or the new (tape-optimized) format. If you enter the RMU Dump After_Journal command without the **Format** qualifier, the default is the **Format=Old_Tape** qualifier. You must specify the same **Format** qualifier as was used with the RMU Backup After_Journal command or the RMU Optimize After_Journal command. If your .aij file resides on disk, you should use the **Format=Old_File** qualifier.

If you specified the **Format=Old_File** qualifier when you optimized or backed up the .aij file to tape, you must mount the backup media by using the DCL MOUNT command before you issue the RMU Dump After_Journal command. Because the RMU Dump After_Journal command uses RMS to read the tape, the tape must be mounted as an OpenVMS volume (that is, do not specify the /FOREIGN qualifier with the MOUNT command).

If you specify the **Format=New_Tape** qualifier, you must mount the backup media by using the DCL MOUNT /FOREIGN command before you issue the RMU Dump After_Journal command.

Similarly, if you specify OpenVMS access (you do not specify the /FOREIGN qualifier on the DCL MOUNT command) although your .aij backup was created using the **Format=New_Tape** qualifier, you receive an RMU-F-MOUNTFOR error.

The following tape qualifiers have meaning only when used in conjunction with the **Format=New_Tape** qualifier:

- Active_IO
- Label
- Rewind

1.20 RMU Dump After_Journal Command

Label=(label-name-list)

Specifies the 1- to 6-character string with which the volumes of the backup file have been labeled. The Label qualifier is applicable only to tape volumes. You must specify one or more label names when you use the Label qualifier.

You can specify a list of tape labels for multiple tapes. If you list multiple tape label names, separate the names with commas and enclose the list of names within parentheses.

In a normal dump after-journal operation, the Label qualifier you specify with the RMU Dump After_Journal command should be the same Label qualifier you specified with the RMU Backup After_Journal command to back up your after-image journal file.

The Label qualifier can be used with indirect file references. See Section 1.3 for more information.

Larea=integer

Identifies a logical database storage area by number. Dump output is limited to the specified area. The minimum value is 0.

Last=(select-list)

Allows you to specify where you want the dump output to end. (See the First=(select-list) qualifier for the beginning range.) If you specify more than one keyword in the select-list, separate the keywords with commas and enclose the list in parentheses. If you specify multiple items in the select list, the first occurrence is the one that will activate Oracle RMU.

The First and Last qualifiers are optional. You can specify both, either, or neither of them. The keywords specified for the First qualifier can differ from the keywords specified for the Last qualifier.

The select-list of the Last qualifier consists of a list of one or more of the following keywords:

- **BLOCK=block-number**
Specifies the last block in the AIJ journal.
- **RECORD=record-number**
Specifies the last record in the AIJ journal. This is the same as the existing End qualifier, which is still supported but obsolete.
- **TID=tid**
Specifies the last TID in the AIJ journal.
- **TIME=date_time**

1.20 RMU Dump After_Journal Command

Specifies the last date and time in the AIJ journal, using absolute or delta date-time format.

- TSN=tsn

Specifies the last TSN in the AIJ journal, using the standard [n:]m TSN format.

By default, the entire .ajj file is dumped.

Librarian[=options]

Use the Librarian qualifier to restore files from data archiving software applications that support the Oracle Media Management interface. The file name specified on the command line identifies the stream of data to be retrieved from the Librarian utility. If you supply a device specification or a version number it will be ignored.

Oracle RMU supports retrieval using the Librarian qualifier only for data that has been previously stored by Oracle RMU using the Librarian qualifier.

The Librarian qualifier accepts the following options:

- Trace_file=file-specification

The Librarian utility writes trace data to the specified file.

- Level_Trace=n

Use this option as a debugging tool to specify the level of trace data written by the Librarian utility. You can use a pre-determined value of 0, 1, or 2, or a higher value defined by the Librarian utility. The pre-determined values are :

- Level 0 traces all error conditions. This is the default.
- Level 1 traces the entry and exit from each Librarian function.
- Level 2 traces the entry and exit from each Librarian function, the value of all function parameters, and the first 32 bytes of each read/write buffer, in hexadecimal.

- Logical_Names=(logical_name=equivalence-value,...)

You can use this option to specify a list of process logical names that the Librarian utility can use to specify catalogs or archives where Oracle Rdb backup files are stored, Librarian debug logical names, and so on. See the specific Librarian documentation for the definition of logical names. The list of process logical names is defined by Oracle RMU prior to the start of any Oracle RMU command that accesses the Librarian utility.

1.20 RMU Dump After_Journal Command

The following OpenVMS logical names must be defined for use with a Librarian utility before you execute an Oracle RMU backup or restore operation. Do not use the Logical_Names option provided with the Librarian qualifier to define these logical names.

- **RMU\$LIBRARIAN_PATH**

This logical name must be defined so that the shareable Librarian image can be loaded and called by Oracle RMU backup and restore operations. The translation must include the file type (for example, .exe), and must not include a version number. The shareable Librarian image must be an installed (known) image. See the Librarian utility documentation for the name and location of this image and how it should be installed.

- **RMU\$DEBUG_SBT**

This logical name is not required. If it is defined, Oracle RMU will display debug tracing information messages from modules that make calls to the Librarian shareable image.

You cannot use device specific qualifiers such as Rewind, Density, or Label with the Librarian qualifier because the Librarian utility handles the storage media, not Oracle RMU.

Line=integer

Identifies a database line number. Dump output is limited to the specified line. The minimum value is 0. This qualifier is intended for use during analysis or debugging.

Media Loader

Nomedia Loader

Use the Media Loader qualifier to specify that the tape device from which the file is being read has a loader or stacker. Use the Nomedia Loader qualifier to specify that the tape device does not have a loader or stacker.

By default, if a tape device has a loader or stacker, Oracle RMU should recognize this fact. However, occasionally Oracle RMU does not recognize that a tape device has a loader or stacker. Therefore, when the first tape has been read, Oracle RMU issues a request to the operator for the next tape, instead of requesting the next tape from the loader or stacker. Similarly, sometimes Oracle RMU behaves as though a tape device has a loader or stacker when actually it does not.

If you find that Oracle RMU is not recognizing that your tape device has a loader or stacker, specify the Media Loader qualifier. If you find that Oracle RMU expects a loader or stacker when it should not, specify the Nomedia Loader qualifier.

1.20 RMU Dump After_Journal Command

Only=(select-list)

Allows you to specify one select list item to output. (See also the First=(select-list) and Last=(select-list) qualifiers for specifying a range.) If you specify more than one keyword in the select-list, separate the keywords with commas and enclose the list in parentheses. If you specify multiple items in the select list, the first occurrence is the one that will activate Oracle RMU.

The Only qualifier is optional.

The select-list of the Only qualifier consists of a list of one or more of the following keywords:

- TID=tid
Specifies a TID in the AIJ journal.
- TSN=tsn
Specifies a TSN in the AIJ journal, using the standard [n:]m TSN format.
- Type=type-list
Specifies the types of records to be dumped. The type-list consists of a list of one or more of the following keywords:
 - Ace_header
Type=A records
 - Checkpoint
Type=B records
 - Close
Type=K records
 - Commit
Type=C records
 - Data
Type=D records
 - Group
Type=G records
 - Information
Type=N records
 - Open
Type=O records

1.20 RMU Dump After_Journal Command

- Optimize_information
Type=I records
- Prepare
Type=V records
- Rollback
Type=R records

By default, the entire .ajj file is dumped.

Option=Statistics

Option=Nostatistics

The Option=Statistics qualifier specifies that you want Oracle RMU to include statistics on how frequently database pages are referenced by the data records in the .ajj file. In addition, if the database root file is available, the output created by the Options=Statistics qualifier includes the value to specify for the Aij_Buffers qualifier of the RMU Recover command. If several .ajj files will be used in your recovery operation, perform an RMU Dump After_Journal on each .ajj file and add the recommended Aij_Buffer values. Use the total as the value you specify with the Aij_Buffers qualifier. See Example 2 in the Examples section for an example using this qualifier.

Note that the value recommended for the RMU Recover command's Aij_Buffers qualifier is the *exact* number of buffers required by the data records in the specified .ajj file. If you specify fewer buffers, you may see more I/O, but you will not necessarily see performance degrade. (Performance also depends on whether asynchronous batch-writes are enabled.)

Using more buffers than are recommended may result in your process doing more paging than required, and if so, performance degrades.

If you specify the recommended value, note that this does not mean that no buffers are replaced during the recovery operation. The Oracle RMU buffer replacement strategy is affected by whether asynchronous prefetches and asynchronous batch-writes are enabled, and on the contents of the buffers before the recovery operation begins.

If the database root file is not available, the Option=Statistics qualifier does not provide a value for the RMU Recover command's Aij_Buffers qualifier. However, it does provide the statistics on the frequency with which each page is accessed.

Specify the Option=Nostatistics qualifier to suppress .ajj statistics generation.

The default for the RMU Dump After_Journal command is Option=Statistics.

1.20 RMU Dump After_Journal Command

Output=file-name

Specifies the name of the file where output will be sent. The default is SYS\$OUTPUT. The default file type is .lis, if you specify a file name.

Page=integer

Identifies a database page number. Dump output is limited to the specified page. The minimum value is 1. This qualifier is intended for use during analysis or debugging.

Prompt=Automatic

Prompt=Operator

Prompt=Client

Specifies where server prompts are to be sent. When you specify Prompt=Automatic, prompts are sent to the standard input device, and when you specify Prompt=Operator, prompts are sent to the server console. When you specify Prompt=Client, prompts are sent to the client system.

Rewind

Norewind

Specifies that the magnetic tape that contains the backup file will be rewound before processing begins. The tape is searched for the backup file starting at the beginning-of-tape (BOT). The Norewind qualifier is the default and causes a search for the backup file to be started at the current tape position.

The Rewind and Norewind qualifiers are applicable only to tape devices.

Start=integer

Specifies the number of the first data block that you want to display. If you do not use the Start qualifier, the display begins with the first record in the .ajj file.

State=Prepared

Specifies a list of all records associated with unresolved transactions.

For more information on listing unresolved transactions with the RMU Dump After_Journal command, see the *Oracle Rdb7 Guide to Distributed Transactions*.

1.20 RMU Dump After_Journal Command

Usage Notes

- The First and Last qualifiers have been added to make dumping portions of the .ajj file easier. The Start and End qualifiers were intended to provide similar functionality, but are difficult to use because you seldom know, nor can you determine, the AIJ record number prior to issuing the command.
- Be careful when searching for TSNs or TIDs as they are not ordered in the AIJ journal. For example, if you want to search for a specific TSN, use the Only qualifier and not the First and Last qualifiers. For example, assume the AIJ journal contains records for TSN 150, 170, and 160 (in that order). If you specify the First=TSN=160 and Last=TSN=160 qualifiers, nothing will be dumped because TSN 170 will match the Last=TSN=160 criteria.
- To use the RMU Dump After_Journal command for an .ajj file, you must have the RMU\$DUMP privilege in the root file access control list (ACL) for the database or the OpenVMS SYSPRV or BYPASS privilege.
- You receive a file access error message regarding the database's .ajj file if you issue the RMU Dump After_Journal command with the active .ajj file when there are active processes updating the database. To avoid the file access error message, use the RMU Close command to close the database (which stops entries to the .ajj file), then issue the RMU Dump After_Journal command.
- See the *Oracle Rdb Guide to Database Maintenance* for information on the steps Oracle RMU follows for tape label checking when you execute an RMU Dump After_Journal command using magnetic tapes.
- Use of the wrong value for the Format qualifier typically results in a failure, but sometimes may produce unintelligible results.
- The RMU Dump After_Journal command does not validate the file being dumped. If the file is not an .ajj file or a backup of an .ajj file, the RMU Dump After_Journal command produces unintelligible output.

Examples

Example 1

The following command generates a list of records associated with unresolved transactions in the .ajj file:

```
$ RMU/DUMP/AFTER_JOURNAL/STATE=PREPARED PERSONNEL.AJJ
```

Example 2

1.20 RMU Dump After_Journal Command

The following example shows the value to specify with the Aij_Buffers qualifier along with information on how frequently each page is accessed. The output from this example shows that you should specify the Aij_Buffers=29 qualifier when you recover aij_one.ajj. In addition, it shows that pages (1:623-625) were referenced 37 times which means that 8.9% of all data records in the dumped after-image journal file reference this page.

```
$ RMU/DUMP/AFTER_JOURNAL/OPTION=STATISTICS aij_one.ajj
:
.
Use "/AIJ_BUFFERS=29" when recovering this AIJ journal
1 recovery buffer referenced 37 times (1:623-625): 8.9%
1 recovery buffer referenced 23 times (4:23-25): 5.5%
1 recovery buffer referenced 22 times (4:5-7): 5.3%
1 recovery buffer referenced 21 times (4:44-46): 5.0%
1 recovery buffer referenced 20 times (4:50-52): 4.8%
1 recovery buffer referenced 19 times (4:41-43): 4.6%
2 recovery buffers referenced 18 times (4:38-40): 8.7%
1 recovery buffer referenced 17 times (4:17-19): 4.1%
1 recovery buffer referenced 16 times (4:29-31): 3.8%
2 recovery buffers referenced 15 times (4:35-37): 7.2%
1 recovery buffer referenced 14 times (4:2-4): 3.3%
2 recovery buffers referenced 13 times (4:11-13): 6.3%
3 recovery buffers referenced 12 times (4:8-10): 8.7%
2 recovery buffers referenced 11 times (5:2-4): 5.3%
4 recovery buffers referenced 10 times (4:14-16): 9.7%
1 recovery buffer referenced 9 times (4:47-49): 2.1%
2 recovery buffers referenced 8 times (1:617-619): 3.8%
1 recovery buffer referenced 6 times (4:20-22): 1.4%
1 recovery buffer referenced 2 times (1:503-505): 0.4%
Journal effectiveness: 97.3%
175 data records
412 data modification records
423 total modification records
2 commit records
3 rollback records
```

See the *Oracle Rdb Guide to Database Maintenance* and the *Oracle Rdb7 Guide to Distributed Transactions* for more examples of the RMU Dump After_Journal command.

Example 3

The following example shows how to start a dump from Block 100 or TSN 52, whichever occurs first.

```
$ RMU/DUMP/AFTER_JOURNAL /FIRST=(BLOCK=100,TSN=0:52) mf_personnel.ajj
```

Example 4

1.20 RMU Dump After_Journal Command

This example shows how to dump committed records only.

```
$ RMU/DUMP/AFTER_JOURNAL /ONLY=(TYPE=COMMIT) mf_personnel.ajj
```

Example 5

This example shows the dump output when you specify an area, a page, and a line.

```
RMU/DUMP/AFTER_JOURNAL/AREA=3/PAGE=560/LINE=1 mf_personnel.ajj
*-----
* Oracle Rdb X7.1-00                               3-NOV-2005
10:42:23.56
*
* Dump of After Image Journal
*   Filename: DEVICE:[DIRECTORY]MF_PERSONNEL.AIJ;1
*
*-----
2/4          TYPE=D, LENGTH=122, TAD= 3-NOV-2005 10:31:12.56, CSM=00
TID=6, TSN=0:640, AIJBL_START_FLG=01, FLUSH=00, SEQUENCE=1
MODIFY: PDBK=3:560:1, LDBID=0, PSN=0, FLAGS=00, LENGTH=84
          0022 0000 line 1 (3:560:1) record type 34
          00 0001 0002 Control information
          .... 79 bytes of static data
86726576696C6F54343631303000010D 0005 data '...00164Toliver.'
5020363431411120846E69766C410420 0015 data ' .Alvin. .A146 P'
009820876563616C50206C6C656E7261 0025 data 'arnell Place. .'
3330484E12208B6175726F636F684307 0035 data '.Chocorua. .NH03'
20F03100630F72B31C00004D373138 0045 data '817M...³r.c.1ð '
2/6          TYPE=D, LENGTH=224, TAD= 3-NOV-2005 10:31:12.56, CSM=00
TID=6, TSN=0:641, AIJBL_START_FLG=01, FLUSH=00, SEQUENCE=3
MODIFY: PDBK=3:560:1, LDBID=0, PSN=1, FLAGS=00, LENGTH=84
          0022 0000 line 1 (3:560:1) record type 34
          00 0001 0002 Control information
          .... 79 bytes of static data
86726576696C6F54343631303000010D 0005 data '...00164Toliver.'
5020363431411120846E69766C410420 0015 data ' .Alvin. .A146 P'
009820876563616C50206C6C656E7261 0025 data 'arnell Place. .'
3330484E12208B6175726F636F684307 0035 data '.Chocorua. .NH03'
20F03100630F72B31C00004D373138 0045 data '817M...³r.c.1ð '
3/9          TYPE=D, LENGTH=330, TAD= 3-NOV-2005 10:31:12.73, CSM=00
TID=6, TSN=0:642, AIJBL_START_FLG=01, FLUSH=00, SEQUENCE=5
MODIFY: PDBK=3:560:1, LDBID=0, PSN=2, FLAGS=00, LENGTH=84
```

1.20 RMU Dump After_Journal Command

```
0022 0000 line 1 (3:560:1) record type 34
00 0001 0002 Control information
      .... 79 bytes of static data
86726576696C6F54343631303000010D 0005 data '...00164Toliver.'
5020363431411120846E69766C410420 0015 data ' .Alvin. .A146 P'
009820876563616C50206C6C656E7261 0025 data 'arnell Place. .'
3330484E12208B6175726F636F684307 0035 data ' .Chocorua. .NH03'
  20F03100630F72B31C00004D373138 0045 data '817M...³r.c.1ð '
```

Use "/AIJ_BUFFERS=3" when recovering this AIJ journal.
Make sure you have enough working set and pagefile quota
for the recommended number of buffers.

```
1 recovery buffer referenced 3 times (3:559-561): 50.0%
1 recovery buffer referenced 2 times (3:436-438): 33.3%
1 recovery buffer referenced 1 time (3:134-136): 16.6%
Journal effectiveness: 54.5%
```

```
3 data records
6 data modification records
11 total modification records
3 commit records
```

1.21 RMU Dump Backup_File Command

1.21 RMU Dump Backup_File Command

Displays or writes to a specified output file the contents of a backup file. Use this command to examine the contents of a backup (.rbf) file created by the RMU Backup command.

Format

<u>Command Qualifiers</u>	<u>Defaults</u>
/Active_IO=max-reads	/Active_IO=3
/Disk_File={(Reader_Threads=n)}	/Disk_file=(Reader_Threads=1)
/Encrypt={(Value={Name=},[Algorithm=])}	See description
/Journal=file-name	See description
/Label=(label-name-list)	See description
/Librarian[=options]	None
/[No]Media_Loader	See description
/Options=options-list	See description
/Output=file-name	/Output=SYSS\$OUTPUT
/Process=process-list	See description
/Prompt={Automatic Operator Client}	See description
/Restore_Options=file-name	None
/[No]Rewind	/Norewind
/Skip=skip-list	See description

Description

The RMU Dump Backup_File command reads an .rbf file and displays the contents. It uses an .rbf file, not a database file, as its parameter, and is a separate command from the RMU Dump command. The output captures unrecoverable media errors and indicates if there are unknown backup blocks on tape. This command can be used to confirm that a backup file is formatted correctly and that the media is readable for the RMU Restore command.

Note

Successful completion of this command does not guarantee that data in a backup file is uncorrupt, nor that the backup file is complete, nor that a restore operation will succeed.

1.21 RMU Dump Backup_File Command

Use the Root, Full, or Debug option to the Option qualifier to dump the database backup header information. The database backup header information includes the name of the backup file and the “Backup file database version”. The “Backup file database version” is the version of Oracle Rdb that was executing at the time the backup file was created. The “Oracle Rdb structure level” listed in the section entitled “Database Parameters” is the currently executing version of Oracle Rdb.

The backup header information is contained on the first volume of a database backup file on tape.

Command Parameters

backup-file-spec

A file specification for the backup file. The default file type is .rbf.

If you use multiple tape drives, the backup-file-spec parameter must include the tape device specifications. Separate the device specifications with commas. For example:

```
$ RMU/DUMP/BACKUP_FILE $111$MUA0:PERS_FULL.rbf,$112$MUA1: -  
_$_ /LABEL=BACK01
```

When multiple volume tape files are processed, Oracle RMU dismounts and unloads all but the last volume containing the file, which is the customary practice for multiple volume tape files. See the *Oracle Rdb Guide to Database Maintenance* for more information on using multiple tape drives.

Command Qualifiers

Active_IO=max-reads

Specifies the maximum number of read operations from the backup file that the RMU Dump Backup_File command will attempt simultaneously. The value of the Active_IO qualifier can range from 1 to 5. The default value is 3. Values larger than 3 might improve performance with multiple tape drives.

Disk_File=[(Reader_Threads=integer)]

Specifies that you want to dump a multiple disk backup file. This is a backup file that was created by the RMU Backup command with the Disk_File qualifier.

The Reader_Threads keyword specifies the number of threads that Oracle RMU should use when performing a multithreaded read operation from disk files. You can specify no more than one reader thread per device specified on the command line (or in the command parameter options file). By default, one reader thread is used.

1.21 RMU Dump Backup_File Command

This qualifier and all qualifiers that control tape operations (Label, Media_Loader, and Rewind) are mutually exclusive.

Encrypt={Value= | Name=}[,Algorithm=]

Specify a key value as a string or, the name of a predefined key. If no algorithm name is specified the default is DESCBC. For details on the Value, Name and Algorithm parameters see HELP ENCRYPT.

This feature requires the OpenVMS Encrypt product to be installed and licensed on this system.

Journal=file-name

Allows you improve tape performance by the dump backup file operation by specifying the journal file created by the RMU Backup command with the Journal qualifier.

The RMU Backup command with the Journal qualifier creates the journal file and writes to it a description of the backup operation, including identification of the tape volumes, their contents, and the tape drive name.

The RMU Dump Backup File with the Journal qualifier directs the RMU Dump Backup_File command to read the journal file and identify the tape volumes when the Label qualifier is not specified.

The journal file must be the one created at the time the backup operation was performed. If the wrong journal file is supplied, an informational message is generated, and the specified journal file is not used to identify the volumes to be processed.

Label=(label-name-list)

Specifies the 1- to 6-character string with which the volumes of the backup file have been labeled. The Label qualifier is applicable only to tape volumes. You must specify one or more label names when you use the Label qualifier.

You can specify a list of tape labels for multiple tapes. If you list multiple tape label names, separate the names with commas, and enclose the list of names within parentheses.

In a normal dump backup operation, the Label qualifier you specify with the RMU Dump Backup_File command should be the same Label qualifier as you specified with the RMU Backup command that backed up your database.

If no label is specified, the system will internally generate one consisting of the first six characters in the backup-file-spec parameter.

See the *Oracle Rdb Guide to Database Maintenance* for information on tape label processing.

1.21 RMU Dump Backup_File Command

The Label qualifier can be used with indirect file references. See Section 1.3 for more information.

Librarian[=options]

Use the Librarian qualifier to restore files from data archiving software applications that support the Oracle Media Management interface. The file name specified on the command line identifies the stream of data to be retrieved from the Librarian utility. If you supply a device specification or a version number it will be ignored.

Oracle RMU supports retrieval using the Librarian qualifier only for data that has been previously stored by Oracle RMU using the Librarian qualifier.

The Librarian qualifier accepts the following options:

- **Reader_Threads=n**

Use the Reader_Threads option to specify the number of backup data streams to read from the Librarian utility. The value of *n* can be from 1 to 99. The default is one reader thread. The streams are named BACKUP_FILENAME.EXT, BACKUP_FILENAME.EXT02, BACKUP_FILENAME.EXT03, up to BACKUP_FILENAME.EXT99. BACKUP_FILENAME.EXT is the backup file name specified in the RMU Backup command.

The number of reader threads specified for a database restore from the Librarian utility should be equal to or less than the number of writer threads specified for the database backup. If the number of reader threads exceeds the number of writer threads, the number of reader threads is set by Oracle RMU to be equal to the number of data streams actually stored in the Librarian utility by the backup. If the number of reader threads specified for the restore is less than the number of writer threads specified for the backup, Oracle RMU will partition the data streams among the specified reader threads so that all data streams representing the database are restored.

The Volumes qualifier cannot be used with the Librarian qualifier. Oracle RMU sets the volume number to be the actual number of data streams stored in the specified Librarian utility.

- **Trace_file=file-specification**

The Librarian utility writes trace data to the specified file.

- **Level_Trace=n**

1.21 RMU Dump Backup_File Command

Use this option as a debugging tool to specify the level of trace data written by the Librarian utility. You can use a pre-determined value of 0, 1, or 2, or a higher value defined by the Librarian utility. The pre-determined values are :

- Level 0 traces all error conditions. This is the default.
- Level 1 traces the entry and exit from each Librarian function.
- Level 2 traces the entry and exit from each Librarian function, the value of all function parameters, and the first 32 bytes of each read/write buffer, in hexadecimal.
- Logical_Names=(logical_name=equivalence-value,...)
You can use this option to specify a list of process logical names that the Librarian utility can use to specify catalogs or archives where Oracle Rdb backup files are stored, Librarian debug logical names, and so on. See the specific Librarian documentation for the definition of logical names. The list of process logical names is defined by Oracle RMU prior to the start of any Oracle RMU command that accesses the Librarian utility.

The following OpenVMS logical names must be defined for use with a Librarian utility before you execute an Oracle RMU backup or restore operation. Do not use the Logical_Names option provided with the Librarian qualifier to define these logical names.

- RMU\$LIBRARIAN_PATH
This logical name must be defined so that the shareable Librarian image can be loaded and called by Oracle RMU backup and restore operations. The translation must include the file type (for example, .exe), and must not include a version number. The shareable Librarian image must be an installed (known) image. See the Librarian implementation documentation for the name and location of this image and how it should be installed. For a parallel RMU backup, define RMU\$LIBRARIAN_PATH as a system-wide logical name so that the multiple processes created by a parallel backup can all translate the logical.

```
$ DEFINE /SYSTEM /EXECUTIVE_MODE -  
_$_ RMU$LIBRARIAN_PATH librarian_shareable_image.exe
```
- RMU\$DEBUG_SBT
This logical name is not required. If it is defined, Oracle RMU will display debug tracing information messages from modules that make calls to the Librarian shareable image. For a parallel RMU backup, the RMU\$DEBUG_SBT logical should be defined as a system logical so that

1.21 RMU Dump Backup_File Command

the multiple processes created by a parallel backup can all translate the logical.

The following lines are from a backup plan file created by the RMU Backup /Parallel/Librarian command:

```
Backup File = MF_PERSONNEL.RBF
Style = Librarian
Librarian_trace_level = #
Librarian_logical_names = (-
    logical_name_1=equivalence_value_1, -
    logical_name_2=equivalence_value_2)
Writer_threads = #
```

The "Style = Librarian" entry specifies that the backup is going to a Librarian utility. The "Librarian_logical_names" entry is a list of logical names and their equivalence values. This is an optional parameter provided so that any logical names used by a particular Librarian utility can be defined as process logical names before the backup or restore operation begins. For example, some Librarian utilities provide support for logical names for specifying catalogs or debugging.

You cannot use device specific qualifiers such as Rewind, Density, or Label with the Librarian qualifier because the Librarian utility handles the storage media, not Oracle RMU.

Media_Loader

Nomedia_Loader

Use the Media_Loader qualifier to specify that the tape device from which the backup file is being read has a loader or stacker. Use the Nomedia_Loader qualifier to specify that the tape device does not have a loader or stacker.

By default, if a tape device has a loader or stacker, Oracle RMU should recognize this fact. However, occasionally Oracle RMU does not recognize that a tape device has a loader or stacker. Therefore, when the first tape has been read, Oracle RMU issues a request to the operator for the next tape, instead of requesting the next tape from the loader or stacker. Similarly, sometimes Oracle RMU behaves as though a tape device has a loader or stacker when actually it does not.

If you find that Oracle RMU is not recognizing that your tape device has a loader or stacker, specify the Media_Loader qualifier. If you find that Oracle RMU expects a loader or stacker when it should not, specify the Nomedia_Loader qualifier.

1.21 RMU Dump Backup_File Command

Options=options-list

Specifies the type of information and level of detail the output will include. If you do not specify the Options qualifier or if you specify the Options=Normal qualifier, the backup file will be read, but dump output is not generated. This is useful for confirming that the backup file is structured correctly and the media is readable for the RMU Restore command. However, this command does not indicate if the data in a backup file is corrupted, nor does it guarantee that a restore operation will succeed.

If you specify more than one option, you must separate the options with a comma, and enclose the options-list parameter within parentheses. Eight types of output are available:

- **Records**
Dumps the backup file record structure.
- **Blocks**
Dumps the backup file block structure.
- **Data**
The Data option can be used with either the Records option, the Blocks option, or both. When specified with the Records and Blocks options, the Data option dumps the contents of the backup file's records and blocks. When you do not specify the Data option, the Records and Blocks options dump the backup file's record structure and block structure only, not their contents.
- **Journal**
Dumps the contents of the journal file.
Use the Journal option of the RMU Dump Backup_File command to direct Oracle RMU to dump the journal file created with the RMU Backup command with the Journal qualifier. The RMU Backup command with the Journal qualifier creates a journal file to which it writes a description of the backup operation, including identification of the tape volumes and their contents. You can use the output of the RMU Dump Backup_File with the Journal qualifier to identify the contents of each of the tapes that comprises the backup file.
- **Root**
Dumps the database root file contents as recorded in the backup file. This includes a dump of the database backup header information.
- **Normal**

1.21 RMU Dump Backup_File Command

The backup file will be read, but no dump output is generated. This is useful to verify the integrity of the backup file format and to detect media errors.

- **Full**
Specifying the Full option is the same as specifying the Root, Records, and Blocks options. Includes a dump of the database backup header information. The contents of the backup file's record structure and block structure are not dumped when the Full option is specified.
- **Debug**
Specifying the Debug option is the same as specifying the Root, Records, Blocks, Full, and Data options. The contents of the backup file's header, record structure, and block structure are dumped when the Debug option is specified.

Output=file-name

Specifies the name of the file where output will be sent. The default is SYS\$OUTPUT. The default output file type is .lis, if you specify a file name.

Process=process-list

Specifies a list of keywords that determines how much of the backup file is to be dumped. If you specify more than one type of process-list option, separate the options with a comma, and enclose the process-list parameter within parentheses. You can specify the following three items in the process-list parameter:

- **Volumes=integer**
The number of volumes to dump, starting at the position specified in the Skip qualifier for volumes. This option is ignored if the backup file does not reside on tape.
- **Blocks=integer**
The number of blocks to dump, starting at the position specified in the Skip qualifier for blocks. This option is ignored if the backup file does not reside on tape.
- **Records=integer**
The number of records to dump, starting at the position specified in the Skip qualifier for records. This option is valid regardless of whether the backup file resides on tape or disk.

1.21 RMU Dump Backup_File Command

Prompt=Automatic

Prompt=Operator

Prompt=Client

Specifies where server prompts are to be sent. When you specify Prompt=Automatic, prompts are sent to the standard input device, and when you specify Prompt=Operator, prompts are sent to the server console. When you specify Prompt=Client, prompts are sent to the client system.

Restore_Options=file-name

Generates an options file designed to be used with the Options qualifier of the RMU Restore command.

The Restore_Options file is created after the root information has been read from the backup file.

By default, a Restore_Options file is not created. If you specify the Restore_Options qualifier and a file, but not a file extension, Oracle RMU uses an extension of .opt by default.

Rewind

Norewind

Specifies that the magnetic tape that contains the backup file will be rewound before processing begins. The Norewind qualifier is the default.

The Rewind and Norewind qualifiers are applicable only to tape devices. You should use these qualifiers only when the target device is a tape device.

See the *Oracle Rdb Guide to Database Maintenance* for information on tape label processing.

Skip=skip-list

Specifies a list of keywords that determines where the output display begins. The keywords indicate the position in the backup file from which to start the dump. If you specify more than one type of Skip position, separate the options with a comma, and enclose the skip-list parameter in parentheses. You can specify the following three items in the skip-list parameter:

- Volumes=integer
The number of volumes to ignore before starting. This option is ignored if the backup file does not reside on tape.
- Blocks=integer
The number of blocks to ignore before starting. This option is ignored if the backup file does not reside on tape.
- Records=integer

1.21 RMU Dump Backup_File Command

The number of records to ignore before starting. This option is valid regardless of whether the backup file resides on tape or disk.

Usage Notes

- To use the RMU Dump Backup_File command for a database, you must have the RMU\$DUMP, RMU\$BACKUP, or RMU\$RESTORE privileges in the root file access control list (ACL) for the database or the OpenVMS BYPASS privilege.
You must also have read access to the .rbf file.
- If you do not specify the Options qualifier or if you specify the Options=Normal qualifier, the backup file will be read, but dump output will not be generated. This is useful to verify the backup file integrity and to detect media errors.
- See the *Oracle Rdb Guide to Database Maintenance* for examples that show the RMU Dump Backup_File command.

Examples

Example 1

The following commands show the use of the Journal qualifier with the RMU Backup command and the RMU Dump After_Journal command. The first command creates a binary journal file that identifies the tapes used in the backup operation. The second command directs Oracle RMU to read the backup file (using the tapes identified in the BACKUP_JOURNAL.JNL file) to confirm that the backup file is structured correctly and the media is readable for the RMU Restore command. No dump output is generated because the Option qualifier is not specified.

```
$ RMU/BACKUP MF_PERSONNEL.RDB -  
_ $ $222$DUA20: [BCK]MF_PERSONNEL.RBF/LOG/JOURNAL=BACKUP_JOURNAL.JNL  
  
$ RMU/DUMP/BACKUP_FILE $222$DUA20: [BCK]MF_PERSONNEL.RBF -  
_ $ /JOURNAL=BACKUP_JOURNAL.JNL
```

Example 2

The following commands show the use of the Journal qualifier with the RMU Backup command and then with the RMU Dump Backup command. The first command creates a binary journal file that identifies the tapes used in the backup operation. The second command dumps the binary journal file created in the first command in ASCII format.

1.21 RMU Dump Backup_File Command

```
$ RMU/BACKUP MF_PERSONNEL.RDB -
_ $ $222$DUA20:[BCK]MF_PERSONNEL.RBF/LOG/JOURNAL=BACKUP_JOURNAL.JNL
$ RMU/DUMP/BACKUP_FILE $222$DUA20:[BCK]MF_PERSONNEL.RBF -
_ $ /JOURNAL=BACKUP_JOURNAL.JNL/OPTION=JOURNAL
```

Example 3

The following example demonstrates the use of the `Restore_Options` qualifier. The first command performs a dump operation on the backup file of the `mf_personnel` database and creates a `Restore_Options` file. The second command shows a portion of the contents of the options file. The last command demonstrates the use of the options file with the RMU Restore command.

```
$ RMU/DUMP/BACKUP MFP.RBF /RESTORE_OPTIONS=MFP.OPT -
_ $ /OPTIONS=NORMAL/OUTPUT=DUMP.LIS
$ TYPE MFP.OPT
! Options file for database DISK1:[DB]MF_PERSONNEL.RDB;1
! Created 17-OCT-1995 13:09:57.56
! Created by DUMP BACKUP command

RDB$SYSTEM -
  /file=DISK2:[RDA]MF_PERS_DEFAULT.RDA;1 -
  /extension=ENABLED -
  /read_write -
  /spams -
  /snapshot=(allocation=248, -
              file=DISK3:[SNAP]MF_PERS_DEFAULT.SNP;1)

EMPIDS_LOW -
  /file=DISK3:[RDA]EMPIDS_LOW.RDA;1 -
  /blocks_per_page=2 -
  /extension=ENABLED -
  /read_write -
  /spams -
  /thresholds=(70,85,95) -
  /snapshot=(allocation=10, -
              file=DISK4:[SNAP]EMPIDS_LOW.SNP;1)
.
.
.
$ RMU/RESTORE MFP.RBF/OPTIONS=MFP.OPT
```

1.22 RMU Dump Export Command

1.22 RMU Dump Export Command

Displays the contents of an export interchange (.rbr) file or a formatted .unl file created by the RMU Unload command. This is a useful debugging tool.

Format

RMU/Dump/Export export_file

Command Qualifiers

/[No]Data
/Output=file-name

Defaults

/Data
/Output=SYS\$OUTPUT

Command Parameters

export-file

The .rbr file or formatted .unl file to be displayed.

Command Qualifiers

Data

Nodata

The Data qualifier specifies that the contents of segmented strings and tables are to be displayed in hexadecimal format along with the ASCII translation. Specifying the Nodata qualifier excludes the contents of segmented strings and tables from the display and generates much less output.

The default is the Data qualifier.

Output=file-name

Specifies the name of the file where output is sent. The default is SYS\$OUTPUT. The default output file type is .lis, if you specify a file name.

Usage Notes

- You do not need Oracle RMU privileges to use the RMU Dump Export command. However, you must have OpenVMS read access to the .rbr or .unl file, or OpenVMS BYPASS privilege.

1.22 RMU Dump Export Command

Examples

Example 1

The following is an example of the RMU Dump Export command using the default qualifiers:

```
$ RMU/DUMP/EXPORT EMPLOYEES.UNL

BEGIN HEADER SECTION - (0)
  NONCORE_TEXT HDR_BRP_ID - (38) : Oracle Rdb V7.0 Load/Unload utility
  CORE_NUMERIC HDR_BRPFILE_VERSION - (1) : 4
  NONCORE_TEXT HDR_DBS_ID - (18) : Oracle Rdb V7.0
  NONCORE_TEXT HDR_DB_NAME - (16) : MF_PERSONNEL.RDB
  NONCORE_DATE HDR_DB_LOG_BACKUP_DATE - (8) : 18-JUN-1996 09:31:45.71
END HEADER SECTION - (0)

BEGIN RELATION SECTION - (0)
.
.
.
```

1.23 RMU Dump Recovery_Journal Command

1.23 RMU Dump Recovery_Journal Command

Displays a recovery-unit journal (.ruj) file in ASCII format. Use this command to examine the contents of an .ruj file. You might find .ruj files on your system following a system failure.

An .ruj file contains header information and data blocks. Header information describes the data blocks, which contain copies of data modified in the database file.

Format

RMU/Dump/Recovery_Journal ruj-file-name

Command Qualifiers

/[No]Data
/Output = file-name

Defaults

/Data
/Output=SYS\$OUTPUT

Description

The RMU Dump Recovery_Journal command specifies an .ruj file, not a database file, as its parameter, and is a separate command from the RMU Dump command used to display database areas and header information.

The .ruj file is in binary format. This command translates the binary file into an ASCII display format.

Command Parameters

ruj-file-name

The .ruj file. The default file type is .ruj.

Command Qualifiers

Data

Nodata

Specifies whether you want to display data blocks of the .ruj file or just the .ruj file header.

The Data qualifier is the default. It causes the display of the .ruj file data blocks (in addition to the file header) in an ASCII display format.

The Nodata qualifier limits the display to the file header of the .ruj file.

1.23 RMU Dump Recovery_Journal Command

Output=file-name

The name of the file where output will be sent. The default is SYS\$OUTPUT. The default output file type is .lis, if you specify a file name.

Usage Notes

- You do not need Oracle RMU privileges to use the RMU Dump Recovery_Journal command. However, you must have OpenVMS READ access to the .ruj file or OpenVMS BYPASS privilege to use the RMU Dump Recovery_Journal command.
- The RMU Dump Recovery_Journal command does not validate the file being dumped. If the file is not an .ruj file, the output from the RMU Dump Recovery_Journal command is unintelligible.
- See the *Oracle Rdb Guide to Database Maintenance* for examples showing the RMU Dump Recovery_Journal command.

1.24 RMU Dump Row_Cache Command

1.24 RMU Dump Row_Cache Command

Allows you to display the in-memory contents of a row cache for an open database.

Format

RMU/Dump/Row_Cache root-file-spec

Command Qualifiers

/Cache_Name=cachename

/(No)Data

/Output=file-name

Defaults

None

/Data

/Output=SYS\$OUTPUT

Description

The RMU Dump Row_Cache command is intended for use as a diagnostic aid that allows you to display the in-memory contents of a row cache for an open database. Use this command to display the following information for each row in the specified cache:

- GRIC - Address of the GRIC data structure for the cache slot
- GRIB - Address of the GRIB data structure for the cache slot
- SLOT - Slot number within the cache
- NXTGRIC - Slot number of the next slot within the hash chain
- LHMTE - Flag values indicating:
 - L - Row is latched
 - H - Row is marked Hot (modified since last checkpoint or sweep)
 - M - Row is marked Modified
 - T - Row is marked Too Big for (or removed from) the cache
 - E - End of on-disk checkpoint file; should never be seen with the RMU Dump Row_Cache command
- SNAPPNO - Snapshot pointer (either snapshot page number or snapshot slot number)
- LEN - Length of the row in cache; 0 indicates row has been deleted

1.24 RMU Dump Row_Cache Command

- ACTLEN - Actual length of allocated space on the database page for the row
- DBK - Database key for the row
- REFCNT - Reference count: number of processes with this row in a cache working set
- UPD_PID - Process ID of process currently updating the row in memory
- RVNO - In-memory row modification count
- TSN - Transaction sequence number of last transaction to modify the row

Command Parameters

root-file-spec

Specifies the database root file for which you want to dump the row_cache contents.

Command Qualifiers

Cache_Name=cachename

Specifies the name of the cache you want to dump. You must specify the cache name.

Data

Nodata

The Data qualifier specifies that the in-memory content of a row_cache is to be displayed in hexadecimal format along with the ASCII translation. The Data qualifier is the default.

Specify the Nodata qualifier to display only header information for each cache slot.

Output=filename

Specifies the name of the file where output is to be sent. The default is SYS\$OUTPUT. If you specify a file name, the default output file type is .lis.

1.24 RMU Dump Row_Cache Command

Examples

Example 1

```
$ RMU/DUMP/ROW_CACHE /CACHE_NAME=test mf_personnel
```

```
*-----  
* Oracle Rdb X7.1-00                               21-OCT-2002  13:47:07.82  
*  
* Dump of Row Cache RDB$SYSTEM_CACHE  
*   Database: DPA01:[V71]MF_PERSONNEL.RDB;2  
*  
*-----
```

GRIC	GRIB	SLOT	NXTGRIC	LHMTE	SNAPPNO	LEN	ACTLN	DBK	REFCNT	UPD_PID	RVNO	TSN
3F334580	3F36F400	0	0	_____	-1	430	430	38:2383:1	0	00000000	1	0:3968
3F334598	3F36F800	1	0	_____	-1	430	430	38:1671:0	0	00000000	1	0:3968
3F3345B0	3F36FC00	2	16	_____	-1	220	220	3:2023:2	0	00000000	1	0:3968
3F3345C8	3F370000	3	0	_____	-1	430	430	37:2359:1	0	00000000	1	0:3968
3F3345E0	3F370400	4	0	_____	-1	430	430	37:1665:0	0	00000000	1	0:3968
3F3345F8	3F370800	5	0	_____	-1	208	208	9:2007:0	0	00000000	1	0:3968

1.25 RMU Extract Command

Reads and decodes Oracle Rdb metadata and reconstructs equivalent statements in Relational Database Operator (RDO) or SQL (structured query language) code for the definition of that database. These statements can either be displayed or extracted. You can use these statements to create your database again if you no longer have the RDO or SQL code that defined your database.

In addition, you can direct the RMU Extract command to produce output for the following:

- An SQL or RDO IMPORT script (Items=Import)
- An RMU Unload command for each table (Items=Unload)
- An RMU Load command for each table (Items=Load)
- An RMU Set Audit command for the database (Items=Security)
- An RMU Verify command for the database (Items=Verify)

Format

RMU/Extract root-file-spec

Command Qualifiers

/Defaults[=defaults-list]
 /Items[=item-list]
 /Language=lang-name
 /[No]Log[=log-file]
 /Options=options-list
 /[No]Output[=out-file]
 /Transaction_Type[=
 (transation_mode,options...)]

Defaults

/Defaults=(quoting_rules=SQL92)
 /Items=All
 /Language=SQL
 /Nolog
 /Option=Normal
 /Output=SYS\$OUTPUT
 See Description

Description

The RMU Extract command decodes information and reconstructs equivalent commands in the language you select with the Language qualifier for the definition of that database.

You can extract the definitions to either a file or to SYS\$OUTPUT.

1.25 RMU Extract Command

The RMU Extract command extracts the following character set information:

- For databases:
 - The database default character set
 - The national character set
- For domains:
 - The character set of each character data type domain
 - The length in characters of each character data type domain
- For tables:
 - The character set of each character data type column
 - The length in characters of each character data type column

The RMU Extract command may enclose object names in double quotation marks to preserve uppercase and lowercase characters, special character combinations, or reserved keywords.

Command Parameters

root-file-spec

The file specification for the database root file from which you want to extract definitions. Note that you do not need to specify the file extension. If the database root file is not found, the command exits with a “file not found” error.

Command Qualifiers

Defaults[=defaults-list]

This qualifier is used to change the output of the RMU Extract command. The following defaults can be modified with the Defaults qualifier:

- Allocation
Noallocation

When you create a test database using the script generated by the RMU Extract command, the allocation from the source database may not be appropriate. You can use the Allocation keyword to specify an alternate value to be used by all storage areas, or you can use the Noallocation keyword to omit the clause from the CREATE STORAGE MAP syntax. The default behavior, when neither keyword is used, is to use the allocation recorded in the database for each storage area. See also the Snapshot_Allocation keyword.

1.25 RMU Extract Command

- **Date_Format**
Nodate_Format

By default, the RMU Extract process assumes that DATE types are SQL standard-compliant (that is DATE ANSI) and that the built-in function CURRENT_TIMESTAMP returns TIMESTAMP(2) values. If your environment uses DATE VMS exclusively, then you can modify the default by specifying the default DATE_FORMAT=VMS. The legal values are described in the *Oracle Rdb SQL Reference Manual* in the SET DEFAULT DATE FORMAT section. The default is Date_Format=SQL92.

Use Nodate_Format to omit the setting of this session attribute from the script.
- **Dialect**
Nodialect

For some extracted SQL scripts the language dialect must be specified. You can use the Dialect keyword to supply a specified dialect for the script. You can find the legal values for this option in the Oracle Rdb SQL Reference Manual in the SET DIALECT section. The default is Nodialect.
- **Language**
Nolanguage

The RMU Extract command uses the process language, that is, the translated value of SYS\$LANGUAGE, or ENGLISH, for the SET LANGUAGE command. However, if the script is used on a different system then this language might not be appropriate. You can use the Language keyword to supply a specified language for the script. Legal language names are defined by the OpenVMS system logical name table; examine the logical name SYS\$LANGUAGES for a current set. Use the Nolanguage keyword to omit this command from the script.
- **Quoting_Rules**
Noquoting_Rules

You can use the Quoting_Rules keyword to supply a specified setting for the script. You can find the legal values for this option in the *Oracle Rdb SQL Reference Manual* in the SET QUOTING RULES section. The default is Quoting_Rules=SQL92. The RMU Extract command assumes that SQL keywords and names containing non-ASCII character set values are enclosed in quotation marks.
- **Snapshot_Allocation**
Nosnapshot_Allocation

1.25 RMU Extract Command

When you create a test database from the RMU Extract output, the snapshot file allocation from the source database may not be appropriate. You can use the `Snapshot_Allocation` keyword to specify an alternate value to be used by all snapshot areas, or you can use the `Noallocation` keyword to omit the "snapshot allocation is" clause. The default behavior, when neither keyword is used, is to use the snapshot allocation stored in the database for each snapshot area. See also the `Allocation` keyword.

Items[=item-list]

Allows you to extract and display selected definitions. Note that each of the item names can be combined to provide shorter command lines such as the following:

```
$ RMU/EXTRACT/NOLOG/ITEMS=(ALL,NODATABASE) MF_PERSONNEL
```

If you omit the `Items` qualifier from the command line or specify it without any options, the action defaults to `Items=All`.

The following options can be specified with the `Items` qualifier:

- **All**

Indicates that all database items are to be extracted. This is the default and includes all items except `Alter_Database`, `Forward_References`, `Import`, `Load`, `Protections`, `Revoke_Entry`, `Security`, `Synonyms`, `Unload`, `Verify`, `Volume`, and `Workload` options. You can use either `All` or `Noall` in combination with other items to select specific output.

In the following example, the `Items=All` option causes all the definitions except for `Triggers` to be extracted and displayed:

```
$ RMU/EXTRACT/ITEMS=(ALL,NOTRIGGERS) MF_PERSONNEL
```

The following example displays domain and table definitions. Note that the `Noall` option could have been omitted:

```
$ RMU/EXTRACT/ITEMS=(NOALL, DOMAIN, TABLE) MF_PERSONNEL
```

- **Alter_Database (or Change_Database)**

`Noalter_Database`

Displays the physical database after-image journal object definition.

- **Catalog**
`Nocatalog`

Displays all contents of the catalog created for an SQL multischema database. This item is ignored if the interface is RDO.

- **Collating_Sequences**
`Nocollating_Sequences`

1.25 RMU Extract Command

Displays all the collating sequences defined for the database that you select. Note that Oracle Rdb does not save the name of the source OpenVMS National Character Set (NCS) library and the name becomes the defined logical, NCS\$LIBRARY, by default.

- **Constraints**
Noconstraints

By default, table and column constraints are output by the `Items=Table` qualifier. If you specify `Item=Noconstraints`, constraint information is not extracted for any table. If you specify the `Language=SQL` qualifier, the default is to have `Item=Constraints` enabled when tables are extracted.

To extract all constraints as an `ALTER TABLE` statement, use the `Item=Constraint` and `Option=Defer_Constraints` qualifiers. To force all constraints to be defined after tables are defined, use the `Item=Tables` and `Option=Defer_Constraints` qualifiers.
- **Database**
Nodatabase

Displays the database attributes and characteristics. This includes information such as the database root file name, the number of buffers, the number of users, the repository path name, and the characteristics for each storage area.

If you specify RMU Extract with the `Option=Nodictionary_References` qualifier, the data dictionary path name is ignored.
- **Domains (or Fields)**
Nodomains

Displays the domain definitions. If the domain was originally defined using the data dictionary path name, the output definition shows this. If the `Option=Nodictionary_References` qualifier is specified, the data dictionary path name is ignored and the column attributes are extracted from the system tables.
- **Forward_References**
Noforward_References

Queries the dependency information in the database (`RDB$INTERRELATIONS`) and extracts `DECLARE FUNCTION` and `DECLARE PROCEDURE` statements for only those routines that are referenced by other database objects. The default is `Noforward_Reference`.

The `Forward_References` item is used in conjunction with other `Item` keywords, for example, `/Item=(All,Forward)`.

1.25 RMU Extract Command

- **Functions**
Nofunctions
Displays external function definitions.
- **Import**
Noimport
Generates an RDO or SQL IMPORT script that defines every storage area and row cache. The Language qualifier determines whether Oracle RMU generates an RDO or SQL IMPORT script (If you specify the Language=SQL or the Language=ANSI_SQL qualifier, the same SQL IMPORT script is generated.) Because the RDO interface does not accept many of the database options added to recent versions of Oracle Rdb, Oracle Corporation recommends that you specify the Language=SQL qualifier (or accept the default).

The Items=Import qualifier is useful when you want to re-create a database that is the same or similar to an existing database. Editing the file generated by Oracle RMU to change allocation parameters or add storage areas and so on is easier than writing your own IMPORT script from scratch.

When Oracle RMU generates the IMPORT script, it uses an interchange file name of rmuextract_rbr in the script. Therefore, you must either edit the IMPORT script generated by Oracle RMU to specify the interchange file that you want to import, or assign the logical name RMUEXTRACT_RBR to your interchange file name. (An interchange file is created by an SQL or RDO EXPORT statement.) See Example 14 in the Examples section.
- **Indexes (or Indices)**
Noindexes
Displays index definitions, including storage map information.
- **Load**
Unload
Generates a DCL command procedure containing an RMU Load or RMU Unload command for each table in the database. This item must be specified explicitly, and is not included by default when you use the Items=All qualifier.

Oracle RMU generates the Fields qualifier for the Load and Unload scripts when you specify the Option=Full qualifier. If you do not specify the Option=Full qualifier, the scripts are generated without the Fields qualifier.

1.25 RMU Extract Command

If you specify the RMU Extract command with the Item=Unload qualifier, DCL commands are added to the script to create a file with type .COLUMNS. This file defines all the unloaded columns. The file name of the .COLUMNS file is derived from the name of the extracted table. You can reference the file by using the “@” operator within the Fields qualifier for the RMU Load and RMU Unload commands.

Virtual columns, AUTOMATIC or COMPUTED BY table columns, and VIEW calculated columns appear in the .COLUMNS file as comments.

- Module
Nomodule
Displays procedure and function definitions. This item is valid only when the Language specification is SQL; it is ignored if the Language specification is RDO or ANSI_SQL.
- Outlines
Nooutlines
Displays query outline definitions. This item is valid only when the Language specification is SQL; it is ignored if the Language specification is RDO or ANSI_SQL.
- Procedures
Noprocedures
Extracts external procedures.
- Profiles
Noprofiles
Displays profiles as defined by the CREATE PROFILE statement.
- Protections
Noprotections
Displays the protection access control list (ACL) definitions. If the protections are defined using SQL ANSI semantics, they cannot be represented in RDO. In this case, the diagnostic message warns you that the protections must be extracted using the Language=SQL qualifier. If you specify Language=ANSI_SQL, a diagnostic message warns you that the ACL-style protections cannot be extracted in ANSI format. You must explicitly specify the Protections option. It is not included by default when you use the Items=All qualifier.
- Revoke_Entry
Norevoke_Entry

1.25 RMU Extract Command

Extracts a SQL or RDO script that deletes the protections from all access control lists in the database: database, table, sequences, column, module, function, and procedure.

The output script contains a series of SQL REVOKE ENTRY statements (or DELETE PROTECTION statements if the language selected is RDO) that remove the access control entry for the user and all objects.

- Role
Norole
Displays role definitions as defined by the SQL CREATE ROLE statement. In addition, any roles that have been granted are displayed as a GRANT statement. By default, roles are not extracted, nor are they included when you specify the Items=All qualifier.
- Schema
Noschema
Displays the schema definitions for an SQL multischema database. This option is ignored if the interface is RDO.
- Sequence
Nosequence
Displays the sequence definitions in the database that were originally defined with the SQL CREATE SEQUENCE statement.
- Security
Nosecurity
Displays RMU Audit commands based on information in the database. This item must be specified explicitly, and is not included by default when you use the Items=All qualifier.
- Storage_Maps
Nostorage_Maps
Displays storage map definitions, including the list (segmented string) storage map.
- Synonyms
Nosynonyms
Generates a report of all the synonyms defined for the database. All synonyms of a database object, including synonyms of those synonyms, are grouped together. The output is ordered by creation as recorded by the RDB\$CREATED column.

1.25 RMU Extract Command

This report is useful for viewing all synonyms or moving them to other databases. However, since synonyms refer to many different database objects, a single set of definitions is usually not adequate when defining a new database. Oracle Corporation recommends that you use the Option=Synonym qualifier in most cases.

- Tables (or Relations)

Notables

Displays table definitions in the same order in which they were created in the database.

If the table was originally defined using the data dictionary path name, that path name is used for the definition.

If you specify the Option=Nodictionary_References qualifier, the data dictionary path name is ignored and the table attributes are extracted from the system tables.

If Item=Noconstraints is specified, constraint information is not extracted for any table.

The Items=Tables qualifier handles domains in the following ways:

- The output for this item reflects the original definitions. If a column is based on a domain of a different name, the BASED ON clause is used in RDO, and the domain name is referenced by SQL.
- Any columns that are based on fields in a system table are processed but generate warning messages.
- Certain domains created using RDO in a relation definition cannot be extracted for RDO because it is not possible to distinguish columns defined using a shorthand method as shown in the example that follows. In this case, the column FIELD_1 becomes or is defined as a domain.

```
DEFINE RELATION REL1.  
    FIELD_1    DATATYPE IS TEXT SIZE 10.  
END.
```

However, this type of definition in SQL causes special domains to be created with names starting with SQL\$. In this case, the SQL domain is translated into the following data type:

```
CREATE TABLE TAB1  
    (COLUMN_1    CHAR(10));
```

1.25 RMU Extract Command

The output for this item also includes the table-level constraints that can be applied: PRIMARY KEY, FOREIGN KEY, NOT NULL, UNIQUE, and CHECK. In the case of the CHECK constraint, the expression might not be translated to or from RDO and SQL due to interface differences.

- Triggers
Notriggers
Displays trigger definitions.
- User
Nouser
Displays user definitions as defined by the SQL CREATE USER statement. In addition, if you also specify Role with the Item qualifier, then any roles that have been granted to a user are displayed as GRANT statements. By default, Users are not displayed, nor are they displayed when you specify the Items=All qualifier.
- Verify
Noverify
Causes the generation of an optimal DCL command procedure containing multiple RMU Verify commands. Using this command procedure is equivalent to performing a full verification (RMU Verify with the All qualifier) for the database. This command procedure can be broken down further into partial command scripts to perform partial verify operations. These partial command scripts can then be submitted to different batch queues to do a full verify operation in parallel, or they can be used to spread out a full verify operation over several days by verifying a piece of the database at a time.

A **partitioning algorithm** is a procedure to determine what portions of the database should be verified in the same command script. For example, areas with interrelations should be verified with the same partial command script. A partitioning algorithm considers the following when creating a partial command script from the equivalent RMU Verify command with the All qualifier:

 1. Each storage area is assigned to a partition.
 2. For each table in the database, if the table is not partitioned, the table is put in the partial command script corresponding to that storage area; otherwise, if the table is partitioned across several storage areas, the partitions corresponding to all of the storage areas are merged into one partial command script and the table is added to this partial command script.
 3. For each index in the database, the process shown in step 2 is followed.

1.25 RMU Extract Command

- For an index on a table, the index and table are merged into one partial command script.

The scripts of partial RMU Verify commands are written in the form of a command procedure. Each partial command script is preceded by a label of the form `STREAM_n`: where *n* is an integer greater than 1. For example, to execute the command at label `STREAM_3`;, invoke the command procedure by using the following syntax:

```
$ @<command-procedure-name> STREAM_3
```

The resultant command procedure is set up to accept up to four parameters, P1, P2, P3, and P4, as shown in Table 1–9.

Table 1–9 Parameters for Generated Command File

Parameter	Option	Description
P1	Stream_n	Specifies the command stream to be executed. The variable <i>n</i> is the “number” of the RMU Verify command stream to be executed. If omitted, all command streams are executed.
P2	[No]Log	Specifies whether to use the Log qualifier in the RMU Verify command line. If omitted, the DCL verify switch value is used.
P3	Read_Only Protected Exclusive	Provides the RMU Verify Transaction_Type value. If omitted, Transaction_Type = Protected is used.
P4		Specifies the name of the output file for the RMU Verify Output qualifier. If omitted, Output = SYS\$OUTPUT is used.

- Views
Noviews

Displays view definitions. If the database was defined using SQL, it is possible that the view cannot be represented in RDO. In this case, the diagnostic message warns that the view definition is being ignored, and the user should use `LANGUAGE=SQL` to extract the view. Note the

1.25 RMU Extract Command

following transformations the RMU Extract command makes when it cannot precisely replicate the SQL source code:

- The RMU Extract command cannot precisely replicate derived table column names or correlation names for any select expression.

The RMU Extract command generates new names for correlation names (C followed by a number) and derived table column names (F followed by a number).

For example, suppose you create a view, as follows:

```
SQL> ATTACH 'FILENAME mf_personnel';
SQL> CREATE VIEW DERIVED_1
cont> (F1) AS
cont> SELECT CAST(AVG(JOB_COUNT) AS INTEGER(2))
cont> FROM (SELECT EMPLOYEE_ID, COUNT (*)
cont> FROM JOB_HISTORY
cont> GROUP BY EMPLOYEE_ID) AS EMP_JOBS (EMPLOYEE_ID, JOB_COUNT);
SQL> COMMIT;
```

If you issue the following RMU Extract command, you receive the output shown:

```
$ rmu/extract/item=view/option=(match:DERIVED_1%,noheader,filename_only) -
mf_personnel
set verify;
set language ENGLISH;
set default date format 'SQL92';
set quoting rules 'SQL92';
set date format DATE 001, TIME 001;
attach 'filename MF_PERSONNEL';
create view DERIVED_1
  (F1) as
  (select
    CAST(avg(C2.F2) AS INTEGER(2))
  from
    (select C4.EMPLOYEE_ID, count(*)
     from JOB_HISTORY C4
     group by C4.EMPLOYEE_ID)
  as C2 (F1, F2));
commit work;
```

- The RMU Extract command cannot generate the original SQL source code for the user-supplied names of AS clauses. This is particularly apparent when the renamed select expression is referenced in an ORDER BY clause. In such a case, the RMU Extract command generates correlation names in the form RMU\$EXT_n where n is a number.

1.25 RMU Extract Command

For example, suppose you create a view, as follows:

```
SQL> SET QUOTING RULES 'SQL92';
SQL> CREATE DATA FILE xyz;
SQL> CREATE TABLE DOCUMENT
cont> (REPORT CHAR(10));
SQL> CREATE TABLE REPORTING
cont> (NAME CHAR(5));
SQL> CREATE TABLE "TABLES"
cont> (CODTAB CHAR(5));
SQL> CREATE VIEW VIEW_TEST
cont> (CREDIT,
cont> CODTAB,
cont> CODMON) AS
cont> SELECT
cont> C1.NAME,
cont> C2.CODTAB,
cont> (SELECT C7.REPORT FROM DOCUMENT C7) AS COM
cont> FROM REPORTING C1, "TABLES" C2
cont> ORDER BY C1.NAME ASC, C2.CODTAB ASC, COM ASC;
SQL>
```

If you issue the following RMU Extract command, you receive the output shown:

```
$ RMU/EXTRACT/ITEM=VIEW MF_PERSONNEL.RDB
.
.
.
create view VIEW_TEST
(CREDIT,
 CODTAB,
 CODMON) as
select
  C1.NAME,
  C2.CODTAB,
  (select DOCUMENT.REPORT from DOCUMENT) AS RMU$EXT_1
from REPORTING C1, "TABLES" C2
order by C1."NAME" asc, C2.CODTAB asc, RMU$EXT_1 asc;
```

- **Volume**
Novolume

Displays cardinality information in a PDL-formatted file for use by Oracle Expert for Rdb. This item must be specified explicitly, and is not included by default when the Items=All qualifier is used.

- **Workload**
Noworkload

1.25 RMU Extract Command

Generates a DCL command language script. The script is used with the RMU Insert Optimizer_Statistics command to extract the work load and statistics stored in the RDB\$WORKLOAD table. The unloaded information can be applied after a new database is created using the SQL EXPORT and IMPORT statements, or it can be applied to a similar database for use by the RMU Collect Optimizer_Statistics/Statistic=Workload command.

This item must be specified explicitly, and is not included by default when the Items=All qualifier is used. The default is Noworkload.

You can modify the output of the Item=Workload qualifier by specifying the following keywords with the Option qualifier:

- **Audit_Comment**
Each RMU Insert Optimizer_Statistics statement is preceded by the created and altered date for the workload entry. The default is Noaudit_comment.
- **Filename_Only**
The database file specification output for the RMU Insert Optimizer_Statistics statement is abbreviated to just the filename.
- **Match**
A subset of the workload entries based on the wildcard file name is selected.

Language=lang-name

Allows you to select one of the following interfaces:

- **SQL**
When you specify the Language=SQL qualifier, Oracle RMU generates the Oracle Rdb SQL dialect. The Oracle Rdb SQL dialect is a superset of SQL92 Entry level, with language elements from Intermediate and Full SQL92 levels. It also contains language elements from SQL:1999 and extensions specific to Oracle Rdb.
- **ANSI_SQL**
When you specify the Language=ANSI_SQL qualifier and specify the Option=Normal qualifier, Oracle RMU tries to generate ANSI SQL statements that conform to the ANSI X3.135-1989 SQL standard.

When you specify the Language=ANSI_SQL qualifier and the Option=Full qualifier, Oracle RMU tries to generate SQL statements that conform to the current ANSI and ISO SQL database language standards. Refer to the *Oracle Rdb SQL Reference Manual* for more information.

1.25 RMU Extract Command

Regardless of the Option parameter you specify, any Oracle Rdb specific features (such as DATATRIEVE support clauses and storage maps) are omitted.

- **RDO**

When you specify the RDO language option, Oracle RMU generates RDO statements.

The default is Language=SQL.

The Language qualifier has no effect on the output generated by the Items=Load, Items=Unload, and Items=Verify qualifiers. This is because these qualifiers generate scripts that contain Oracle RMU commands only.

Log[=log-file]

Nolog

Enable or disables log output during execution of the RMU Extract command. The log includes the current version number of Oracle Rdb, and the values of the parameter and qualifiers. The default is Nolog. The default file extension is .log. If you specify Log without specifying a file name, output is sent to SYS\$OUTPUT.

Options=options-list

This qualifier is used to change the output of the RMU Extract command. This qualifier is not applied to output created by the Items=Unload, Items=Load, Items=Security, or the Items=Verify qualifier.

The following options can be specified with the Options qualifier:

- **Audit_Comment**
Noaudit_Comment

Annotates the extracted objects with the creation and last altered timestamps as well as the username of the creator. The date and time values are displayed using the current settings of SYS\$LANGUAGE and LIB\$DT_FORMAT. Noaudit_Comment is the default.

- **Cdd_Constraints**
Nocdd_Constraints

Specifies that tables extracted by pathname include all constraints. The Option=Nocdd_Constraints qualifier is equivalent to the Option=Defer_Constraints qualifier for tables with a pathname. This option is ignored if Item=Noconstraints is specified.

1.25 RMU Extract Command

When you specify the `Cdd_Constraints` option and the `Dictionary_References` option, the RMU Extract command does not generate `ALTER TABLE` statements to add constraints, but instead assumes they will be inherited from the data dictionary.

When you use the `Nocdd_Constraints` option and the `Dictionary_References` option, the RMU Extract command generates `ALTER TABLE` statements to add `FOREIGN KEY` and `CHECK` constraints after all base tables have been created.

- `Cdd_References`
`Nocdd_References`

This option is an alias for `Dictionary_References`.

- `Column_Volume`
`Nocolumn_Volume`

Directs the RMU Extract command to output the table, column, and column segmented string cardinalities based on sorted indexes. Note that this qualifier must be used in combination with the `Items=Volume` qualifier. If the `Items=Volume` qualifier is omitted, cardinalities are not displayed.

RMU Extract generates data of the following type:

```
Volume for schema MF_PERSONNEL
  Default volatility is 5;
  Table WORK_STATUS all is 3;
  Table EMPLOYEES all is 100;
    Column EMPLOYEE_ID all is 100;
    Column LAST_NAME all is 83;
.
.
.
  Table RESUMES all is 3;
    List RESUME
      Cardinality IS 3
        Number of segments is 3
        Average length of segments is 24;
```

- `Debug`
`Nodebug`

Dumps the internal representation for SQL clauses such as `AUTOMATIC AS`, `VALID IF`, `COMPUTED BY`, `MISSING_VALUE`, `DEFAULT_VALUE`, `CONSTRAINTS`, `SQL DEFAULT`, `TRIGGERS`, `VIEWS`, and `STORAGE MAPS` during processing. The keyword `Debug` cannot be specified with the keywords `Normal` or `Full` in the same `Options` qualifier list.

- `Defer_Constraints`
`Nodefer_Constraints`

1.25 RMU Extract Command

Forces all constraints to be defined (using an ALTER TABLE statement) after all tables have been extracted. This option is ignored if Item=Noconstraints is specified.

If Option=Nodefer_Constraints is specified, all constraints are generated with the CREATE TABLE statement. If neither Option=Defer_Constraints nor Option=Nodefer_Constraints is specified, the default behavior is to generate NOT NULL, UNIQUE, and PRIMARY KEY constraints with the CREATE TABLE statement, and generate CHECK and FOREIGN KEY constraints in a subsequent ALTER TABLE statement.

- Dictionary_References
Nodictionary_References

Directs the RMU Extract command to output definitions for domains (fields) and tables (relations) that reference data dictionary path names rather than using the information contained in the Oracle Rdb system tables. In addition to the database statements, this option also displays the data dictionary path name stored in the database. Refer to Example 8 in the Examples section for an example of using this option.

If neither the Option=Dictionary_References qualifier nor the Option=Nodictionary_References qualifier is specified, then Oracle RMU examines the RDB\$RELATIONS and RDB\$FIELDS system tables to determine whether or not any domains or tables refer to the data dictionary. If references are made to the data dictionary, then the Option=Dictionary_References qualifier is the default. Otherwise, it is assumed that the data dictionary is not used, and the default is the Option=Nodictionary_References qualifier.

The Nodictionary_References keyword causes all references to the data dictionary to be omitted from the output. This is desirable if the database definition is to be used on a system without the data dictionary or in a testing environment.

If the Items=Database and Option=Nodictionary_References qualifiers are selected, the data dictionary path name stored in the system table is ignored. For SQL, the NO PATHNAME clause is generated, and for RDO, the clause DICTIONARY IS NOT USED is generated.

If the Items qualifier specifies Domain or Table, and the Option qualifier specifies Nodictionary_References, the output definition includes all attributes stored in the system tables.

- Disable_Objects
Nodisable_Objects

1.25 RMU Extract Command

Requests that all disabled objects be written to the RMU Extract output file as disabled (see the description for the `Omit_Disabled` option). `Disable_Objects` is the default.

The `Nodisable_Objects` option displays the objects but omits the disabling syntax.

- `Domains`
`Nodomains`

The `Nodomains` option is used to eliminate the domain name from within metadata objects. The domain name is replaced by the underlying data type. This option is designed for use with tools that do not recognize this SQL:1999 SQL language feature.

Effect on `/Language=SQL` output:

The default is `Option=Domains`.

A SQL script generated when `Option=Nodomains` was specified does not include the domain name in the `CREATE TABLE` column definition, `CREATE FUNCTION` or `CREATE PROCEDURE` parameter definitions, or any value expression which uses the `CAST` function to convert an expression to a domain data type (such as the `CREATE VIEW` and `CREATE TRIGGER` statements).

The output generated by the RMU Extract command for functions and procedures in the `CREATE MODULE` statement is not affected by the `Option=Nodomains` option because it is based on the original source SQL for the routine body which is not edited by the RMU Extract command.

Effect on `/Language=ANSI_SQL` output:

The default is `Option=Nodomains` when the `Option=Normal` qualifier is specified or is the default. The RMU Extract command does not generate a list of domain definitions even if the `Items=Domains` or `Items=All` qualifier is used. If you want the generated script to include a list of domain definitions, use the `Options=Domains` qualifier:

```
$RMU/EXTRACT/LANGUAGE=ANSI_SQL/OPTION=DOMAINS databasename
```

Use the `Option=Full` qualifier to have the use of domains included in the syntax generated for SQL:1999.

- `Filename_Only`
`Nofilename_Only`

Causes all file specifications extracted from the database to be truncated to only the file name. The use of this qualifier allows for easier relocation of the new database when you execute the created procedure.

1.25 RMU Extract Command

- Full
Nofull
Specifies that if metadata that cannot be translated from the language that defined the database to the equivalent construct in the language specified with the Language qualifier (for example, DEFAULT for SQL and the language selected was RDO) then the metadata is displayed in comments, or Oracle RMU attempts to create a translation that most closely approximates the original construct.
Nofull is identical to the Normal option.
- Group_Table
Nogroup_Table
Specifies that indexes and storage maps are to be extracted and grouped by table. The table is extracted first, then any PLACEMENT VIA index, then any storage map, and finally all other indexes.
When the Group_Table qualifier is combined with the Option=Match qualifier, you can select a table and its related storage map and indexes.
The default behavior is Nogroup_Table, which means that items are extracted and grouped by type.
- Header
Noheader
Specifies that the script header and section headers are included in the extract. This is the default. Because the header has an included date, specifying Noheader to suppress the header may allow easier comparison with other database extractions when you use the OpenVMS DIFFERENCES command.
- Limit_Volume=nn
Nolimit_Volume
Specifies the maximum amount of data to be scanned for segmented fields. The RMU Extract command stops scanning when the limit *nn* is reached. The number of segments and average length of segments are calculated from the data that was scanned. Limit_Volume=1000 is the default.
Nolimit_Volume specifies that a full scan for segmented strings should be done.
- Match:match-string

1.25 RMU Extract Command

The Match option allows selection of wildcard object names from the database. The match string can contain the standard SQL wildcard characters: the percent sign (%) to match any number of characters, and the underscore (_) to match a single character. In addition, the backslash (\) can be used to prefix these wildcards to prevent them from being used in matching. If you are matching a literal backslash, use the backslash twice, as shown in the following example:

```
Option=Match:"A1\\A2%"
```

The match string defaults to the percent sign (%) so that all objects are selected. To select those objects that start with JOB, use the qualifier Option=Match:"JOB%".

From the mf_personnel database, this command displays the definitions for the domains JOB_CODE_DOM and JOB_TITLE_DOM, the tables JOBS and JOB_HISTORY, the index JOB_HISTORY_HASH, and the storage maps JOBS_MAP and JOB_HISTORY_MAP.

The match string can be quoted as shown if the string contains spaces or other punctuation characters used by DCL or other command language interfaces. Most object names are space filled; therefore, follow the match string with the percent sign (%) to match all trailing spaces.

The Match option can be used in conjunction with the Item qualifier to extract specific tables, indexes, and so on, based on their name and type.

If Group_Table is specified, the match name is assumed to match a table name; all indexes for that table will be extracted when the Items=Index qualifier is specified.

- Multischema
Nomultischema

Displays the SQL multischema names of database objects. It is ignored by the Relational Database Operator (RDO).

The Nomultischema option displays only the SQL single-schema names of database objects.

- Normal
Nonormal

Includes only the specific source language code used to define the database. This is the default.

1.25 RMU Extract Command

In addition, this option propagates RDO VALID IF clauses as column CHECK constraints with the attribute NOT DEFERRABLE when the Language specification is SQL or ANSI_SQL. When an RDO VALID IF clause is converted, Oracle RMU generates error messages similar to the following in your log file:

```
%RMU-W-UNSVVALIDIF, VALID IF clause not supported in SQL - ignored
  for DEGREE.
%RMU-I-COLVALIDIF, changed VALID IF clause on domain DEGREE to
  column check constraint for DEGREES.DEGREE
```

The first message is a warning that the VALID IF clause could not be added to the domain definition because the VALID IF clause is not supported by SQL. The second message is an informational message that tells you the VALID IF clause was changed to a column check constraint.

- Omit_Disabled
Noomit_Disabled

Causes all disabled objects to be omitted from the output of the RMU Extract command. This includes indexes that have MAINTENANCE IS DISABLED, USERS with ACCOUNT LOCK, and disabled triggers and constraints.

The Noomit_Disabled option causes all disabled objects to be included in the output from the RMU Extract command. Noomit_Disabled is the default.

- Order_By_Name
Noorder_By_Name

Order_by_Name displays the storage area, cache, and journal names for the items Database, Alter_Database (also known as Change_Database), and Import in alphabetic order by the ASCII collating sequence.

Noorder_By_Name displays the storage area, cache, and journal names for the items Database, Alter_Database, and Import in approximate definition order. The default ordering is approximate because a DROP STORAGE AREA, DROP CACHE, or DROP JOURNAL statement frees a slot that can be reused, thus changing the order. Noorder_By_Name is the default.

You can use the logical name RDMS\$BIND_SORT_WORKFILES to allocate work files, if needed.

Note

If the identifier character set for the database is not MCS or ASCII, then this option is ignored. Characters from other character sets do not

1.25 RMU Extract Command

sort appropriately under the ASCII collating sequence.

- **Synonyms**

Nosynonyms

Causes the synonyms to be extracted immediately after the referenced object, as shown in the following excerpt from an output file created using the **Item=Table** qualifier:

```
create table HISTORICAL_JOB_INFORMATION (  
    EMPLOYEE_ID  
        INTEGER,  
    USER_ID  
        CHAR (15),  
    JOB_TITLE TITLE,  
    START_DATE  
        DATE,  
    CURRENT_SALARY MONEY_IN_DOLLARS  
        default NULL);  
create synonym JOBHIST  
for table HISTORICAL_JOB_INFORMATION;
```

Because synonyms can be referenced from almost any database object, if you keep the definitions close to the target object you can eliminate occurrences of undefined symbols during script execution. The default is **Option=Synonyms**.

Use the **Option=Nosynonyms** qualifier to disable the display of **CREATE SYNONYM** statements. The synonyms referenced in database objects such as module, procedure, trigger, and table definitions are still extracted.

- **Volume_Scan**

Novolume_scan

Directs the RMU Extract command to perform queries to calculate the cardinality of each table, if both the **Items=Volume** and **Options=Volume_Scan** qualifiers are specified. The default is **Options=Novolume_Scan**, in which case the approximate cardinalities are read from the **RDB\$RELATIONS** system table. The **Options=Volume_Scan** option is ignored if the **Items=Volume** qualifier is not selected.

- **Width=n**

Specifies the width of the output files. You can select values from 60 to 512 characters. The default of 80 characters is appropriate for most applications.

1.25 RMU Extract Command

Output=[out-file]

Nooutput

Names the file to which the RMU Extract command writes the data definition language (DDL) statements. The file extension defaults to .rdo, if you specify the Language=RDO qualifier; .sql, if you specify either the Language=SQL or the Language=ANSI_SQL qualifier. If you specify the Volume option only, the output file type defaults to .pdl. If you specify Load, Security, Verify, or Unload only, the output file type defaults to .com. The default is SYS\$OUTPUT. If you disable the output by using the Nooutput qualifier, command scripts are not written to an output file. The Log output can be used to determine which features used by the database cannot be converted to SQL.

Table 1–10 shows the effects of the various combinations of the Language and Options qualifiers.

Table 1–10 Using Qualifiers to Determine Output Selection

Language	Option	Effect on Output
RDO	Normal	Generates RDO syntax.
	Full	Generates RDO syntax.
	Dictionary_References	Outputs path name references to the repository.
	Nodictionary_References	Converts path name references to the repository to RDO syntax.
	Multischema	Ignored by RDO.
SQL	Normal	Generates SQL syntax.
	Full	Tries to convert RDO specific features to SQL (for example, the VALID IF clause).
	Dictionary_References	Outputs path name references to the data dictionary.
	Nodictionary_References	Converts path name references to the data dictionary to SQL syntax.

(continued on next page)

1.25 RMU Extract Command

Table 1–10 (Cont.) Using Qualifiers to Determine Output Selection

Language	Option	Effect on Output
ANSI_SQL	Multischema	Selects SQL multischema naming of objects.
	Normal	Generates ANSI/ISO syntax.
	Full	Generates ANSI/ISO SQL92 syntax supported by SQL.
	Dictionary_References	Ignored for ANSI_SQL.
Any	Nodictionary_References	Converts path name references to the data dictionary to SQL syntax. This is the default for ANSI_SQL.
	Multischema	Selects SQL multischema naming of objects.
	Audit_Comment	Adds a comment before each definition.
	Debug	Annotates output where possible.
	Domains	Replaces domain names for CAST expression, column and parameter definitions, and returns clauses with SQL data type.
	Filename_Only	Truncates all file specifications extracted from the database to only the file name.
	Volume_Scan	Forces a true count of Tables. Only valid for Items=Volume.

Transaction_Type[=(transaction_mode,options,...)]

Allows you to specify the transaction mode, isolation level, and wait behavior for transactions.

Use one of the following keywords to control the transaction mode:

- Automatic

1.25 RMU Extract Command

When `Transaction_Type=Automatic` is specified, the transaction type depends on the current database settings for snapshots (enabled, deferred, or disabled), transaction modes available to the process, and the standby status of the database. Automatic mode is the default.

- `Read_Only`
Starts a READ ONLY transaction.
- `Write`
Starts a READ WRITE transaction.

Use one of the following options with the keyword `Isolation_Level=[level]` to specify the transaction isolation level:

- `Read_Committed`
- `Repeatable_Read`
- `Serializable`. `Serializable` is the default setting.

Refer to the SET TRANSACTION statement in the Oracle Rdb SQL Reference Manual for a complete description of the transaction isolation levels.

Specify the wait setting by using one of the following keywords:

- `Wait`
Waits indefinitely for a locked resource to become available. `Wait` is the default behavior.
- `Wait=n`
The value you supply for *n* is the transaction lock timeout interval. When you supply this value, Oracle Rdb waits *n* seconds before aborting the wait and the RMU Extract session. Specifying a wait timeout interval of zero is equivalent to specifying `Nowait`.
- `Nowait`
Will not wait for a locked resource to become available.

Usage Notes

- To use the RMU Extract command for a database, you must have the `RMU$UNLOAD` privilege in the root file access control list (ACL) for the database or the OpenVMS `SYSPRV` or `BYPASS` privilege.

1.25 RMU Extract Command

- For tutorial information on using output from the RMU Extract command to load or unload a database, refer to the *Oracle Rdb Guide to Database Design and Definition*.
- Included in the output from the RMU Extract command is the SQL SET DEFAULT DATE FORMAT statement. This SQL statement determines whether columns with the DATE data type or CURRENT_TIMESTAMP built-in function are interpreted as OpenVMS or SQL92 format. The RMU Extract command always sets the default to SQL92. The SQL92 format DATE and CURRENT_TIMESTAMP contain only the YEAR to DAY fields. The OpenVMS format DATE and CURRENT_TIMESTAMP contain YEAR to SECOND fields.

If your database was defined with OpenVMS format DATE and CURRENT_TIMESTAMP, the default SQL SET DEFAULT DATE FORMAT 'SQL92' in the RMU Extract output causes errors to be returned when you attempt to execute that output. For example, when you define a trigger:

```
SQL> CREATE TRIGGER SALARY_HISTORY_CASCADE_UPDATE
cont>     AFTER UPDATE OF JOB_CODE ON JOB_HISTORY
cont>     (UPDATE SALARY_HISTORY SH
cont>         SET SALARY_START = CURRENT_TIMESTAMP
cont>         WHERE (SH.EMPLOYEE_ID = JOB_HISTORY.EMPLOYEE_ID)
cont>         ) for each row;
%SQL-F-UNSDATASS, Unsupported date/time assignment from <Source>
to SALARY_START
```

You can avoid these errors by editing the output from the RMU Extract command. Replace the SET DEFAULT DATE FORMAT 'SQL92' statement with SET DEFAULT DATE FORMAT 'VMS'. If the problem occurs in trigger definitions, you can use the CAST function instead. Specify CAST(CURRENT_TIMESTAMP AS DATE VMS) with each trigger definition that references CURRENT_TIMESTAMP. (You cannot use the CAST function within the DEFAULT clause of an SQL CREATE statement).

- The following list contains a description of what the RMU Extract command generates when it encounters certain RDO statements:
 - RDO and the data dictionary have the concept of validation clauses at the domain level. The ANSI/ISO SQL92 standard allows CHECK constraints defined on domains. While the actions of the ANSI/ISO CHECK constraint do differ from VALID IF in some respects, the RMU Extract command extracts the VALID IF clauses as domain CHECK constraints if you specify the Language=SQL and Option=Full qualifiers.
 - RDO multiline descriptions

1.25 RMU Extract Command

Because the RDO interface removes blank lines in multiline descriptions, the description saved in the metadata is not identical to that entered by the database definition. The RMU Extract command therefore cannot completely reconstruct the original description.

- Some RDO trigger definitions

RDO trigger definitions that contain a trigger action within a join of two or more tables generates invalid SQL syntax. For example, the following RDO trigger definition includes a join with an embedded ERASE statement. When the RMU Extract command encounters this statement, Oracle RMU generates the invalid SQL trigger definition shown.

```
DEFINE TRIGGER EXAMPLE
  AFTER ERASE
  FOR C1 IN EMPLOYEES
  EXECUTE
    FOR C2 IN JOB_HISTORY
    CROSS C3 IN EMPLOYEES
    WITH ((C2.EMPLOYEE_ID = C3.EMPLOYEE_ID)
        AND (C2.JOB_END MISSING))
        AND (C3.EMPLOYEE_ID = C2.EMPLOYEE_ID))
    ERASE C2
  END_FOR
  FOR EACH RECORD.

CREATE TRIGGER EXAMPLE
  AFTER DELETE ON EMPLOYEES
  (DELETE FROM JOB_HISTORY C2, EMPLOYEES C3
   WHERE ((C2.EMPLOYEE_ID = C3.EMPLOYEE_ID)
        AND (C2.JOB_END IS NULL))
        AND (C3.EMPLOYEE_ID = C2.EMPLOYEE_ID))
  ) FOR EACH ROW;
```

Note that in Oracle Rdb Version 4.1 and higher, including a trigger action within a join of two or more tables is invalid RDO syntax. For more information on this RDO restriction, see the ERASE and MODIFY entries in RDO HELP.

- Oracle CDD/Repository Version 5.3 and higher support table and column constraint definition and maintenance through CDO. The RMU Extract command, by default, assumes all constraint maintenance is with SQL and so follows each CREATE TABLE with an ALTER TABLE FROM pathname to add the constraints. However, this is no longer necessary if you are using the later versions of Oracle CDD/Repository. To disable the output of the SQL ALTER TABLE statements which add constraints use the Option=Cdd_Constraint qualifier.

1.25 RMU Extract Command

- If the `Transaction_Type` qualifier is omitted from the RMU Extract command line, a `READ ONLY` transaction is started against the database. This behavior is provided for backward compatibility with prior Oracle Rdb releases. If the `Transaction_Type` qualifier is specified without a transaction mode, the default value `Automatic` is used.
- If the database has snapshots disabled and the `Transaction_Type` qualifier was omitted, the transaction is restarted as `READ WRITE ISOLATION LEVEL READ COMMITTED` to reduce the number of rows locked by operations performed with the `Option=Volume_Scan` qualifier enabled.
- When `Transaction_Type=Write` is specified, the RMU Extract process does not attempt to write to the database tables.
- In previous versions, Oracle Rdb used derived column names based on position, for example, `F1`, `F2`. With release 7.0.6.4 and later, Oracle Rdb promotes the column names from the base table into the derived column name list. The result is a more readable representation of the view or trigger definition.

In the following example the column name `EMPLOYEE_ID` is propagated through the derived table. In previous releases this would be named using a generic label `F1`.

```
create view SAMPLE_V
  (EMPLOYEE_ID,
   COUNTS) as
  select
    C1.EMPLOYEE_ID,
    C1.F2
  from
    (select C2.EMPLOYEE_ID,
     (select count(*) from SALARY_HISTORY C3
      where (C3.EMPLOYEE_ID = C2.EMPLOYEE_ID))
     from JOB_HISTORY C2) as C1 ( EMPLOYEE_ID, F2 )
  order by C1.F2 asc;
```

- The following list shows the equivalent SQL expressions matched by the RMU Extract process:
 - `NULLIF (a, b)` is equivalent to

```
CASE
  WHEN a = b THEN NULL
  ELSE a
END
```

1.25 RMU Extract Command

- NVL (a, ..., b) or COALESCE (a, ..., b) is equivalent to

```
CASE
  WHEN a IS NOT NULL THEN a
  ...
  ELSE b
END
```

- The simple CASE expression

```
CASE a
  WHEN b THEN v1
  WHEN NULL THEN v2
  ...
  ELSE v3
END
```

is equivalent to

```
CASE
  WHEN a = b THEN v1
  WHEN a IS NULL THEN v2
  ...
  ELSE v3
END
```

The RMU Extract procedure tries to decode the internal representation to as compact a SQL expression as possible.

- The RMU Extract procedure decodes case expressions into ABS (Absolute) functions:

ABS(a) is equivalent to:

```
CASE
  WHEN a < 0 THEN -a
  ELSE a
END
```

In addition, similar forms of CASE expression are also converted to ABS:

```
CASE
  WHEN a <= 0 THEN -a
  ELSE a
END
```

```
CASE
  WHEN a > 0 THEN a
  ELSE -a
END
```

1.25 RMU Extract Command

```
CASE
  WHEN a >= 0 THEN a
  ELSE -a
END
```

It is possible that the RMU Extract process will change existing CASE expressions into this more compact syntax, even if they were not originally coded as an ABS function call.

- If the Group_Table option is used and the Item qualifier omits one or more of the Table, Index, or Storage_Map keywords, only the included items are displayed. For example, to extract just the indexes for the EMPLOYEES table:

```
$ RMU/EXTRACT/ITEM=INDEX/OPTION=(GROUP_TABLE, MATCH=EMPLOYEES%)
```

To extract only the storage map and indexes for a table, use the following command:

```
$ RMU/EXTRACT/ITEM=(STORAGE_MAP, INDEX)/OPTION=(GROUP_TABLE, -
_ $ MATCH=EMPLOYEES%)
```

- If the name of the LIST storage map is not known, it can be extracted using the following generic command:

```
$ RMU/EXTRACT/ITEM=STORAGE_MAP/OPTION=(GROUP_TABLE, -
_ $ MATCH=RDB$SEGMENTED_STRING%)
```

Examples

Example 1

The following command extracts these database items: COLLATING_SEQUENCES, DOMAINS, TABLES, INDEXES, STORAGE_MAPS, VIEWS, SEQUENCES, and TRIGGERS.

The All option is the default. The All or Noall option can be used in conjunction with other items to select specific output. For example, the Items=(All, Nodatabase) qualifier selects all metadata items except the physical database characteristics.

```
$ RMU/EXTRACT/ITEM=(ALL, NODATABASE) MF_PERSONNEL
```

Example 2

The following command generates a DCL command procedure containing an RMU Load command for each table in the database:

```
$ RMU/EXTRACT/ITEMS=LOAD MF_PERSONNEL
```

1.25 RMU Extract Command

Example 3

The following command displays the protection access control list (ACL) definitions in the `mf_personnel.rdb` database:

```
$ RMU/EXTRACT/ITEMS=PROTECTIONS MF_PERSONNEL.RDB
```

Example 4

The following command generates a DCL command procedure containing an RMU Unload command for each table in the database:

```
$ RMU/EXTRACT/ITEMS=UNLOAD MF_PERSONNEL.RDB
```

Example 5

The following example displays index definitions:

```
$ RMU/EXTRACT/ITEMS=INDEXES MF_PERSONNEL
```

Example 6

The following example displays domain and table definitions. Note that the `Noall` option could have been omitted.

```
$ RMU/EXTRACT/ITEMS=(NOALL,DOMAINS,TABLES) MF_PERSONNEL
```

Example 7

The following example displays definitions for domains (fields) and tables (relations) that reference data dictionary path names rather than using the information contained in the Oracle Rdb system tables. In addition to the database statements, it also references the data dictionary path name stored in the database, as shown in the following example:

```
$ RMU/EXTRACT/LANG=SQL/ITEM=ALL/OPTION=DIC/OUTPUT=CDD_MODEL.LOG/LOG= -  
_ $ CDD_EXTRACT.LOG CDD_SQL_DB
```

Example 8

The following example creates a command procedure containing a script of partial RMU Verify commands or verify command partitions for the `mf_personnel` database. This command procedure was created with the following RMU Extract command:

```
$ RMU/EXTRACT/ITEM=VERIFY MF_PERSONNEL
```

Example 9

The following command displays a query outline definition that was previously added to the `mf_personnel` database:

```
$ RMU/EXTRACT/ITEMS=(OUTLINES) MF_PERSONNEL
```

1.25 RMU Extract Command

Example 10

The following command displays the after-image journal (.aij) file configuration for mf_personnel:

```
$ RMU/EXTRACT/ITEMS=(ALTER_DATABASE) MF_PERSONNEL
```

Example 11

The following command displays the function definitions in mf_personnel for functions previously created using SQL:

```
$ RMU/EXTRACT/ITEM=FUNCTION MF_PERSONNEL
```

Example 12

The following command displays the table and column cardinalities based on sorted indexes:

```
$ RMU/EXTRACT/OPTION=COLUMN_VOLUME/ITEM=VOLUME MF_PERSONNEL
```

Example 13

The following example:

- Executes an SQL EXPORT statement to create an interchange file.
- Executes an RMU Extract command with the Item=Import qualifier to generate an Import script. In addition, the Option=Filename_Only qualifier is specified to prevent full file specifications from appearing in the SQL IMPORT script. (If full file specifications are used, you cannot test the script without replacing the database that was exported.)
- Defines a logical to define the interchange file name used in the Import script file.
- Executes the Import script file.

```
SQL> -- Create interchange file, SAVED_PERS.RBR.  
SQL> --  
SQL> EXPORT DATABASE FILENAME MF_PERSONNEL.RDB INTO SAVED_PERS.RBR;  
SQL> EXIT;  
$ !  
$ RMU/EXTRACT/ITEM=IMPORT/OPTION=FILENAME_ONLY/OUTPUT=IMPORT_PERS.SQL -  
_ $ MF_PERSONNEL  
$ DEFINE/USER RMUEXTRACT_RBR SAVED_PERS.RBR  
$ !
```

1.25 RMU Extract Command

```
$ SQL$
SQL> @IMPORT_PERS.SQL
SQL> set language ENGLISH;
SQL> set default date format 'SQL92';
SQL> set quoting rules 'SQL92';
SQL> set date format DATE 001, TIME 001;
SQL>
SQL> -- RMU/EXTRACT for Oracle Rdb V7.2-00      2-JAN-2006 15:34:38.63
SQL> --
SQL> --                                     Physical Database Definition
SQL> --
SQL> -----
SQL> import database from rmuextract_rbr
cont>   filename 'MF_PERSONNEL'
.
.
.
```

Example 14

The following example shows an extract from the generated script when the `SYSS$LANGUAGE` and `LIB$DT_FORMAT` symbols are defined. The language and format will default to `ENGLISH` and the standard OpenVMS format if these logical names are not defined.

```
$ DEFINE LIB$DT_FORMAT LIB$DATE_FORMAT_002,LIB$TIME_FORMAT_001
$ DEFINE SYSS$LANGUAGE french
$ RMU/EXTRACT/OUT=SYSS$OUTPUT/ITEM=DOMAIN MF_PERSONNEL/OPT=AUDIT_COMMENT
.
.
.
-- Created on 8 janvier 2006 13:01:31.20
-- Never altered
-- Created by RDB_EXECUTE
--
SQL> CREATE DOMAIN ADDRESS_DATA_1
cont> CHAR (25)
cont> comment on domain ADDRESS_DATA_1 is
cont>   ' Street name';
.
.
.
```

Example 15

If a database has snapshots set to `ENABLED DEFERRED`, it may be preferable to start a read/write transaction. In this environment, using the `Transaction_type=(Read_only)` qualifier causes a switch to a temporary snapshots `ENABLED IMMEDIATE` state. This transition forces the `READ ONLY` transaction to wait while all `READ WRITE` transactions complete, and then all new `READ WRITE` transactions performing updates will start

1.25 RMU Extract Command

writing rows to the snapshot files for use by possible read only transactions. To avoid this problem use an RMU Extract command specifying a READ WRITE ISOLATION LEVEL READ COMMITTED transaction.

```
$ RMU/EXTRACT/ITEM=TABLE/OUT=TABLES.SQL-  
  /TRANSACTION_TYPE=(WRITE, ISOLATION=READ) -  
  SAMPLE.RDB
```

Example 16

This example specifies the options which were the default transaction style in prior releases.

```
$ RMU/EXTRACT/ITEM=TABLE/OUT=TABLES.SQL-  
  /TRANSACTION_TYPE=(READ_ONLY) -  
  SAMPLE.RDB
```

Example 17

If the database currently has snapshots deferred, it may be more efficient to start a read-write transaction with isolation level read committed. This allows the transaction to start immediately (a read-only transaction may stall), and the selected isolation level keeps row locking to a minimum. This could be explicitly stated by using the following command:

```
$ RMU/EXTRACT-  
  /TRANSACTION_TYPE=(WRITE, ISOLATION=READ_COMMITTED) -  
  SAMPLE.RDB
```

Using a transaction type of automatic adapts to different database settings:

```
$ RMU/EXTRACT-  
  /TRANSACTION_TYPE=(AUTOMATIC) -  
  SAMPLE.RDB
```

Example 18

This example shows the use of the Item=Workload qualifier to create a DCL command language script.

1.25 RMU Extract Command

```
$ RMU/EXTRACT/ITEM=WORKLOAD -
  SCRATCH/LOG/OPTION=(FILENAME,AUDIT)
$! RMU/EXTRACT for Oracle Rdb V7.2-00          7-JAN-2006 22:00:42.72
$!
$!                                WORKLOAD Procedure
$!
$!-----
$ SET VERIFY
$ SET NOON
$
$! Created on 7-JAN-2006 10:12:26.36
$! Last collected on 7-JAN-2006 22:00:34.47
$!
$ RMU/INSERT OPTIMIZER_STATISTICS -
  SCRATCH -
  /TABLE=(CUSTOMERS) -
  /COLUMN_GROUP=(CUSTOMER_NAME) -
  /DUPLICITY_FACTOR=(4.0000000) -
  /NULL_FACTOR=(0.0000000) /LOG
$
$! Created on 7-JAN-2006 10:12:26.36
$! Last collected on 7-JAN-2006 22:00:34.58
$!
$ RMU/INSERT OPTIMIZER_STATISTICS -
  SCRATCH -
  /TABLE=(RDB$FIELDS) -
  /COLUMN_GROUP=(RDB$FIELD_NAME) -
  /DUPLICITY_FACTOR=(1.7794118) -
  /NULL_FACTOR=(0.0000000) /LOG
$
.
.
.
$ SET NOVERIFY
$ EXIT
```

Example 19

The following example shows the use of the Match option to select a subset of the workload entries based on the wildcard file name.

1.25 RMU Extract Command

```
$ RMU/EXTRACT/ITEM=WORKLOAD -
  SCRATCH/LOG/OPTION=(FILENAME,AUDIT,MATCH:RDB$FIELDS%)
$! RMU/EXTRACT for Oracle Rdb V7.2-00                8-JAN-2006 10:53
$!
$!                                WORKLOAD Procedure
$!
$!-----
$ SET VERIFY
$ SET NOON
$
! Created on 7-JAN-2006 15:18:02.30
$ SET NOON
$
$! Created on 7-JAN-2006 15:18:02.30
$! Last collected on 7-JAN-2006 18:25:04.27
$!
$ RMU/INSERT OPTIMIZER_STATISTICS -
  SCRATCH -
  /TABLE=(RDB$FIELDS) -
  /COLUMN_GROUP=(RDB$FIELD_NAME) -
  /DUPLICITY_FACTOR=(1.0000000) -
  /NULL_FACTOR=(0.0000000) /LOG
$ SET NOVERIFY
$ EXIT
```

Example 20

The following example shows the use of Item options `Defer_Constraints`, `Constraints`, and `Match` to extract a table and its constraints.

1.25 RMU Extract Command

```
$ RMU/EXTRACT/ITEM=(TABLE,CONSTRAINT) -
_$/OPTION=(FILENAME_ONLY,NOHEADER, -
_$(DEFER_CONSTRAINT,MATCH:EMPLOYEES%) -
_$(MF_PERSONNEL
set verify;
set language ENGLISH;
set default date format 'SQL92';
set quoting rules 'SQL92';
set date format DATE 001, TIME 001;
attach 'filename MF_PERSONNEL';
create table EMPLOYEES (
    EMPLOYEE_ID ID_DOM,
    LAST_NAME LAST_NAME_DOM,
    FIRST_NAME FIRST_NAME_DOM,
    MIDDLE_INITIAL MIDDLE_INITIAL_DOM,
    ADDRESS_DATA_1 ADDRESS_DATA_1_DOM,
    ADDRESS_DATA_2 ADDRESS_DATA_2_DOM,
    CITY CITY_DOM,
    STATE STATE_DOM,
    POSTAL_CODE POSTAL_CODE_DOM,
    SEX SEX_DOM,
    BIRTHDAY DATE_DOM,
    STATUS_CODE STATUS_CODE_DOM);
comment on table EMPLOYEES is
    'personal information about each employee';
alter table EMPLOYEES
    add constraint EMP_SEX_VALUES
        check(EMPLOYEES.SEX in ('M', 'F', '?'))
        deferrable
    add constraint EMP_STATUS_CODE_VALUES
        check(EMPLOYEES.STATUS_CODE in ('0', '1', '2', 'N'))
        deferrable
    alter column EMPLOYEE_ID
        constraint EMPLOYEES_PRIMARY_EMPLOYEE_ID
        primary key
        deferrable;
commit work;
```

Example 21

The following example shows the use of the option `Group_Table` to extract a table and its indexes:

1.25 RMU Extract Command

```
$ rmu/extract/item=(table,index)-
_$/option=(group_table,match=employees%,-
_$/filename_only,noheader) db$:mf_personnel
set verify;
set language ENGLISH;
set default date format 'SQL92';
set quoting rules 'SQL92';
set date format DATE 001, TIME 001;
attach 'filename MF_PERSONNEL';
create table EMPLOYEES (
  EMPLOYEE_ID ID_DOM
    constraint EMPLOYEES_PRIMARY_EMPLOYEE_ID
      primary key
      deferrable,
  LAST_NAME LAST_NAME_DOM,
  FIRST_NAME FIRST_NAME_DOM,
  MIDDLE_INITIAL MIDDLE_INITIAL_DOM,
  ADDRESS_DATA_1 ADDRESS_DATA_1_DOM,
  ADDRESS_DATA_2 ADDRESS_DATA_2_DOM,
  CITY CITY_DOM,
  STATE STATE_DOM,
  POSTAL_CODE POSTAL_CODE_DOM,
  SEX SEX_DOM,
  BIRTHDAY DATE_DOM,
  STATUS_CODE STATUS_CODE_DOM);
comment on table EMPLOYEES is
  'personal information about each employee';

create unique index EMPLOYEES_HASH
  on EMPLOYEES (
    EMPLOYEE_ID)
  type is HASHED SCATTERED
  store
    using (EMPLOYEE_ID)
    in EMPIDS_LOW
      with limit of ('00200')
    in EMPIDS_MID
      with limit of ('00400')
    otherwise in EMPIDS_OVER;

create unique index EMP_EMPLOYEE_ID
  on EMPLOYEES (
    EMPLOYEE_ID
      asc)
  type is SORTED
  node size 430
  disable compression;

create index EMP_LAST_NAME
  on EMPLOYEES (
    LAST_NAME
      asc)
  type is SORTED;
```

1.25 RMU Extract Command

```
commit work;

alter table EMPLOYEES
  add constraint EMP_SEX_VALUES
    check(EMPLOYEES.SEX in ('M', 'F', '?'))
    deferrable
  add constraint EMP_STATUS_CODE_VALUES
    check(EMPLOYEES.STATUS_CODE in ('0', '1', '2', 'N'))
    deferrable;

commit work;
```

Example 22

The following example shows the output when you use the Item=Revoke_Entry qualifier:

```
$ RMU/EXTRACT/ITEM=REVOKE_ENTRY ACCOUNTING_DB
...
--                               Protection Deletions
--
```

```
-----
revoke entry
  on database alias RDB$DBHANDLE
  from [RDB,JAIN];

revoke entry
  on database alias RDB$DBHANDLE
  from [RDB,JONES];

revoke entry
  on database alias RDB$DBHANDLE
  from PUBLIC;

revoke entry
  on table ACCOUNT
  from [RDB,JONES];

revoke entry
  on table ACCOUNT
  from PUBLIC;

revoke entry
  on table ACCOUNT_BATCH_PROCESSING
  from [RDB,JONES];

revoke entry
  on table ACCOUNT_BATCH_PROCESSING
  from PUBLIC;

revoke entry
  on table BILL
  from [RDB,JONES];
```

1.25 RMU Extract Command

```
revoke entry
  on table BILL
  from PUBLIC;
...
```

Example 23

The following example shows sample output for the WORK_STATUS table of MF_PERSONNEL. The uppercase DCL commands are generated by RMU Extract.

```
$ RMU/EXTRACT/ITEM=UNLOAD-
_ $ /OPTION=(NOHEADER,FULL,MATCH:WORK_STATUS%) sql$database
$ CREATE WORK_STATUS.COLUMNS
! Columns list for table WORK_STATUS
! in DISK1:[DATABASES]MF_PERSONNEL.RDB
! Created by RMU Extract for Oracle Rdb V7.2-00 on 1-JAN-2006 20:50:25.33
STATUS_CODE
STATUS_NAME
STATUS_TYPE
$ RMU/UNLOAD -
      DISK1:[DATABASES]MF_PERSONNEL.RDB -
      /FIELDS="@WORK_STATUS.COLUMNS" -
      WORK_STATUS -
      WORK_STATUS.UNL
$
$ EXIT

$ RMU/EXTRACT/ITEM=LOAD-
_ $ /OPTION=(NOHEADER,FULL,MATCH:WORK_STATUS%) sql$database
$ RMU/LOAD -
      /TRANSACTION_TYPE=EXCLUSIVE -
      /FIELDS="@WORK_STATUS.COLUMNS" -
      DISK1:[DATABASES]MF_PERSONNEL.RDB -
      WORK_STATUS -
      WORK_STATUS.UNL
$
$ EXIT
```

Example 24

The following example shows how to extract all constraints as an ALTER TABLE statement.

1.25 RMU Extract Command

```
$ rmu/extract/item=(notab,constr) db$:sql_personnel/opt=(nohead,mat=empl%,defer)
set verify;
set language ENGLISH;
set default date format 'SQL92';
set quoting rules 'SQL92';
set date format DATE 001, TIME 001;
attach 'filename $DISK1:[JONES]SQL_PERSONNEL.RDB';
alter table EMPLOYEES
  add constraint EMP_SEX_VALUES
    check((EMPLOYEES.SEX in ('M', 'F')
           or (EMPLOYEES.SEX is null)))
    initially deferred deferrable
  add constraint EMP_STATUS_CODE_VALUES
    check((EMPLOYEES.STATUS_CODE in ('0', '1', '2')
           or (EMPLOYEES.STATUS_CODE is null)))
    initially deferred deferrable
alter column EMPLOYEE_ID
  constraint EMP_EMPLOYEE_ID_NOT_NULL
    not null
    initially deferred deferrable;
```

1.26 RMU Insert Optimizer_Statistics Command

1.26 RMU Insert Optimizer_Statistics Command

Inserts workload records into the RDB\$WORKLOAD system relation.

Format

RMU Insert Optimizer_Statistics root-file-spec

Command Qualifiers

/Column_Group=(Column-list)
/Duplicity_Factor=(floating-number)
/[No]Log[=file-spec]
/Null_Factor=(floating-number)
/Tables=(table-list)

Defaults

None - Required Qualifier
/Duplicity_Factor=(1.0)
See description
/Null_Factor=(0.0)
None - Required Qualifier

Description

When you enable and collect workload statistics, the system table RDB\$WORKLOAD is created and populated. (See Section 1.15 for details.) You can update or delete these statistics using the RMU Collect Optimizer_Statistics command or the RMU Delete Optimizer_Statistics command, respectively.

You might delete entries in the RDB\$WORKLOAD table by accident or you might delete them to test how effective it is to maintain those particular workload statistics. If you decide that you want to maintain those deleted statistics, you can insert them with the RMU Insert Optimizer_Statistics command. To ensure that you insert accurate values, always issue an RMU Show Optimizer_Statistics command with the Log qualifier before you issue an RMU Delete Optimizer_Statistics command. Refer to your generated log file for the values you should specify with the RMU Insert Optimizer_Statistics command.

In addition you can use the RMU Insert Optimizer_Statistics command to create workload statistics in a copy of your master database.

If you issue an RMU Collect Optimizer_Statistics command after having issued an RMU Insert Optimizer_Statistics command, statistics for the specified column groups are updated.

1.26 RMU Insert Optimizer_Statistics Command

Command Parameters

root-file-spec

Specifies the database into which optimizer statistics are to be inserted. The default file type is .rdb.

Command Qualifiers

Column_Group=(column-list)

Specifies a list of columns that comprise a column group. You must use the Tables qualifier to specify the table or tables with which the columns are associated.

The Column_Group=(column-list) qualifier is a required qualifier.

Duplicity_Factor=(floating_number)

Specifies the value to be inserted in the RDB\$DUPLICITY_FACTOR column in the RDB\$WORKLOAD table for the specified column group and table (or tables). The minimum value is 1.0 and the maximum value is the cardinality of the specified table. The default is the Duplicity_Factor=(1.0) qualifier.

Log**Log=file-spec****Nolog**

Specifies how the statistics inserted into the RDB\$WORKLOAD system table are to be logged. Specify the Log qualifier to have the information displayed to SYS\$OUTPUT. Specify the Log=file-spec qualifier to have the information written to a file. Specify the Nolog qualifier to prevent display of the information. If you do not specify any of variation of the Log qualifier, the default is the current setting of the DCL verify switch. (The DCL SET VERIFY command controls the DCL verify switch.)

Null_Factor=floating-number

Specifies the value to be inserted in the RDB\$NULL_FACTOR column in the RDB\$WORKLOAD table for the specified column group and table (or tables). The minimum value is 0.0 and the maximum value is 1.0. The default is the Null_Factor=(0.0) qualifier.

Tables=(table-list)**Tables**

Specifies the table or tables for which column group entries are to be inserted.

If you issue an RMU Collect Optimizer_Statistics command after you have inserted a workload column group into the RDB\$WORKLOAD system table, those statistics are collected.

1.26 RMU Insert Optimizer_Statistics Command

The Tables=(table-list) qualifier is a required qualifier.

Usage Notes

- To use the RMU Insert Optimizer_Statistics command for a database, you must have the RMU\$ANALYZE privilege in the root file access control list (ACL) for the database or the OpenVMS SYSPRV or BYPASS privilege.
- Cardinality statistics are automatically maintained by Oracle Rdb. Physical storage and workload statistics are only collected when you issue an RMU Collect Optimizer_Statistics command. To get information about the usage of physical storage and workload statistics for a given query, define the RDMS\$DEBUG_FLAGS logical name to be "O". For example:

```
$ DEFINE RDMS$DEBUG_FLAGS "O"
```

When you execute a query, if workload and physical statistics have been used in optimizing the query, you will see a line such as the following in the command output:

```
~0: Workload and Physical statistics used
```
- The Insert Optimizer_Statistics command modifies the RDB\$LAST_ALTERED date of the RDB\$WORKLOAD row so that it is activated for use by the optimizer.

Examples

Example 1

The following example:

1. Collects workload statistics for the JOB_HISTORY table using the RMU Collect Optimizer_Statistics command
2. Deletes the statistics for one of the JOB_HISTORY workload column groups
3. Inserts the statistics that were just deleted into the RDB\$WORKLOAD system table using the RMU Insert Optimizer_Statistics command
4. Displays the current data stored in the RDB\$WORKLOAD table for the JOB_HISTORY table using the RMU Show Optimizer_Statistics command

1.26 RMU Insert Optimizer_Statistics Command

```
$ RMU/COLLECT OPTIMIZER_STATISTICS MF_PERSONNEL.RDB -
_$/TABLE=(JOB_HISTORY)/STATISTICS=(WORKLOAD)/LOG
Start loading tables... at 3-JUL-1996 10:54:04.16
Done loading tables... at 3-JUL-1996 10:54:04.69
Start collecting workload stats... at 3-JUL-1996 10:54:06.76
Maximum memory required (bytes) = 6810
Done collecting workload stats... at 3-JUL-1996 10:54:07.64
Start calculating stats... at 3-JUL-1996 10:54:07.84
Done calculating stats... at 3-JUL-1996 10:54:07.86
Start writing stats... at 3-JUL-1996 10:54:09.34

-----

Optimizer Statistics collected for table : JOB_HISTORY

Workload Column group :      EMPLOYEE_ID
Duplicity factor       : 2.7400000
Null factor            : 0.0000000

Workload Column group :      EMPLOYEE_ID,  JOB_CODE,      JOB_START,
JOB_END,              DEPARTMENT_CODE,  SUPERVISOR_ID
Duplicity factor       : 1.5930233
Null factor            : 0.3649635
Done writing stats... at 3-JUL-1996 10:54:09.90
$ RMU/DELETE OPTIMIZER_STATISTICS MF_PERSONNEL.RDB -
_$/TABLE=(JOB_HISTORY)/COLUMN_GROUP=(EMPLOYEE_ID, JOB_CODE, -
_$/JOB_START, JOB_END, DEPARTMENT_CODE, SUPERVISOR_ID)/LOG
Changing RDB$SYSTEM area to READ_WRITE.
Workload column group deleted for JOB_HISTORY :      EMPLOYEE_ID,
JOB_CODE,      JOB_START,      JOB_END,      DEPARTMENT_CODE,
SUPERVISOR_ID
$ !
$ RMU/INSERT OPTIMIZER_STATISTICS MF_PERSONNEL.RDB -
_$/TABLE=(JOB_HISTORY) /COLUMN_GROUP=(EMPLOYEE_ID, JOB_CODE, -
_$/JOB_START, JOB_END, DEPARTMENT_CODE, SUPERVISOR_ID) -
_$/DUPLICITY_FACTOR=(1.5930233)/NULL_FACTOR=(0.3649635)/LOG
Changing RDB$SYSTEM area to READ_WRITE.
Workload column group inserted for JOB_HISTORY :      EMPLOYEE_ID,
JOB_CODE,      JOB_START,      JOB_END,      DEPARTMENT_CODE,
SUPERVISOR_ID
$ !
$ RMU/SHOW OPTIMIZER_STATISTICS MF_PERSONNEL.RDB -
_$/TABLE=(JOB_HISTORY)/STATISTICS=(WORKLOAD)/LOG

-----

Optimizer Statistics for table : JOB_HISTORY

Workload Column group :      EMPLOYEE_ID
Duplicity factor       : 2.7400000
Null factor            : 0.0000000
First created time    : 3-JUL-1996 10:37:36.43
Last collected time   : 3-JUL-1996 10:54:09.62
```

1.26 RMU Insert Optimizer_Statistics Command

```
Workload Column group :   EMPLOYEE_ID, JOB_CODE,   JOB_START,  
JOB_END,   DEPARTMENT_CODE,   SUPERVISOR_ID  
Duplicity factor      : 1.5930233  
Null factor           : 0.3649635  
First created time    : 3-JUL-1996 10:57:47.65  
Last collected time   : 3-JUL-1996 10:57:47.65
```

1.27 RMU Librarian Command

Allows you to list or remove backed up Oracle Rdb databases from a Librarian utility.

Format

RMU/Librarian backup-file-spec

Command Qualifiers

/List[=(Output=file-name),(options,...)]
/Remove=[No]Confirm,(options,...)]

Defaults

See Description
See Description

Description

The RMU Librarian command allows you to list or remove backed up Oracle Rdb databases from a Librarian utility that conforms to the Oracle Media Manager interface.

You cannot perform both the list and remove operations within one command.

Command Parameters

backup-file-spec

Identifies the backed up Oracle Rdb database previously stored in the Librarian utility. Use the same backup file name that was used in the Oracle RMU Backup command. A default file type of .RBF is assumed if none is specified. Any device, directory, or version number specified with the backup file name will be ignored.

If the Librarian utility supports wild card characters, you can use them for the backup file name when you use the List qualifier. Wild card characters cannot be used with the Remove qualifier.

Command Qualifiers

List[=(Output=file-name),(options,...)]

Allows you to display a backed up Oracle Rdb database stored in a Librarian utility. If you use the List qualifier without the Output option, the output is sent to the default output device. If you use the Output option, the output is sent to the specified file. All data streams existing in the Librarian that were generated for the specified backup name will be listed. The information listed for each data stream can include:

1.27 RMU Librarian Command

- The backup stream name based on the backup file.
- Any comment associated with the backup stream name.
- The creation method associated with the backup stream name. This will always be STREAM.
- The creation data and time when the stream was backed up to the Librarian.
- Any expiration date and time specified for deletion of the stream by the Librarian.
- The media sharing mode that indicates if the media can be accessed concurrently or not.
- The file ordering mode that indicates if files on the media can be accessed in random order or sequential order.
- Any volume labels for the media that contain the backup stream.

Not all of these items will be listed depending on the particular Librarian utility.

The List qualifier can accept the following options:

- `Trace_File=file-specification`
The Librarian application writes trace data to the specified file.
- `Level_Trace=n`
Use this option as a debugging tool to specify the level of trace data written by the Librarian application. You can use a pre-determined value of 0, 1, or 2, or a higher value defined by the Librarian application. The pre-determined values are:
 - Level 0 traces all error conditions. This is the default.
 - Level 1 traces the entry and exit from each Librarian function.
 - Level 2 traces the entry and exit from each Librarian function, the value of all function parameters, and the first 32 bytes of each read/write buffer, in hexadecimal.
- `Logical_Names=(logical-name=equivalence-value,...)`
Use this option to specify a list of process logical names that the Librarian application can use to specify catalogs or archives for listing or removing backup files, Librarian debug logical names, and so on. See the specific Librarian documentation for the definition of the logical names. The list of

1.27 RMU Librarian Command

process logical names is defined by Oracle RMU prior to the start of the list or remove operation.

Remove[=[No]Confirm,(options...)]

Allows you to delete all data streams existing in the Librarian that were generated for the specified backup file. This command should be used with caution. You should be sure that a more recent backup for the database exists in the Librarian under another name before you use this command. The Confirm option is the default. It prompts you to confirm that you want to delete the backup from the Librarian. If you do not want to be prompted, use the Noconfirm option. The deletion will be performed with no confirmation prompt.

The Remove qualifier can accept the following options:

- **Trace_File=file-specification**
The Librarian application writes trace data to the specified file.
- **Level_Trace=n**
Use this option as a debugging tool to specify the level of trace data written by the Librarian application. You can use a pre-determined value of 0, 1, or 2, or a higher value defined by the Librarian application. The pre-determined values are:
 - Level 0, trace all error conditions, is the default.
 - Level 1 traces the entry and exit from each Librarian function.
 - Level 2 traces the entry and exit from each Librarian function, the value of all function parameters, and the first 32 bytes of each read/write buffer, in hexadecimal.
- **Logical_Names=(logical-name=equivalence-value,...)**
You can use this option to specify a list of process logical names that the Librarian application can use to specify catalogs or archives for listing or removing backup files, Librarian debug logical names, and so on. See the specific Librarian documentation for the definition of logical names. The list of process logical names is defined by Oracle RMU prior to the start of the list or remove operation.

1.28 RMU Load Command

1.28 RMU Load Command

Loads data into the tables of the database.

You can use the RMU Load command to:

- Perform the initial load of an Oracle Rdb database.
- Reload a table after performing a restructuring operation.
- Load an archival database.
- Move data from one database to another.
- Load security audit records from an OpenVMS security audit table into the database being audited, or into a different database than the one being audited.
- Load additional rows into an existing table. (However, note that it cannot be used to modify existing rows.)
- Import data into a database from an application that generates RMS files.

You can load data using either of the following two methods:

- A single-process method
This was the only method available prior to Oracle Rdb V7.0. The single process method uses one process to both read the input file and load the target table.
- A multiprocess method, also called a parallel load
The **parallel load** method, which you specify with the Parallel qualifier, enables Oracle RMU to use your process to read the input file and use one or more executors (subprocesses or detached slave process, depending on additional factors) to load the data into the target table. This results in concurrent read and write operations, and in many cases, substantially improves the performance of the load operation.

By default, Oracle RMU sets up a parallel load operation as follows:

- Your process serves as the load operation execution manager.
- Each storage area (partition) in the table being loaded is assigned an executor.
- Each executor is assigned four communications buffers.
(You can override this default with the Buffer_Count option to the Parallel qualifier.)

1.28 RMU Load Command

- Each communications buffer holds the number of rows defined by the Row_Count qualifier.

Once the executors and communications buffers are set up, the parallel load operation processes the input file as follows:

1. Your process begins reading the input file and determines the target storage area for each row in the input file.
2. Your process places each row in the communications buffer for the executor assigned to the data's target storage area.
3. When an executor's first communications buffer becomes full, it begins loading the data into the target storage area.
4. If your process has another portion of data ready for a given executor before that executor has completed loading its first buffer of data, your process places the next portion of data in the second communications buffer for that executor.
5. Each executor, concurrent with each of the other executors, loads the data from its buffers.
6. Your process continues reading, sorting, and assigning data to each executor (by placing it in that executor's communication buffer) until all the data from the input file has been sorted, assigned, and loaded.

The Row_Count qualifier and Parallel qualifier (which provides the Executor_Count and Buffer_Count options) give you the ability to fine tune the Parallel load operation.

See the *Oracle Rdb Guide to Database Design and Definition* for tips on optimizing the performance of the load operation.

1.28 RMU Load Command

Format

RMU/Load root-file-spec table-name input-file-name

Command Qualifiers

/Audit[=Database_File=db-name]
/Buffers=n
/Commit_Every=n
/[No]Constraints[=Deferred]
/Corresponding
/[No]Defer_Index_Updates
/[No]Execute
/Fields=(column-name-list)
/List_Plan=output-file
/[No]Log_Commits
/[No]Match_Name=table-name
/Parallel[=(options)]
/[No]Place
/Record_Definition=
({FilePath}=name[,options])

/[No]Restricted_Access
/Row_Count=n
/[No]Skip=n
/Statistics=(stat-opts)
/Transaction_Type=Share-mode
/[No]Trigger_Relations[=(table_name_list)]

Defaults

No audit table loaded
See description
See description
/Constraints
See description
/Nodefer_Index_Updates
/Execute
See description
See description
/Nolog_Commits
/Nomatch_Name
See description
/Noplace
See description

/Norestricted_Access
See description
/Noskip
See description
Protected
/Trigger_Relations

Description

The RMU Load command accepts the following five types of data files, all of which, except the security audit journal, have the file extension .unl:

- Text data file
- Delimited text data file
- Binary data file
- Specially structured file
- OpenVMS security audit journal file

With the exception of the specially structured file and the security audit journal file, you must provide a record definition file (.rrd) on the RMU Load command line to load these data files. The record definition file provides Oracle RMU with a description of (metadata for) the data you are loading.

1.28 RMU Load Command

The following list describes the additional requirements for loading each of these types of files:

- Text data file

To load a text data file (.unl), you must specify the Record_Definition qualifier with the Format=Text option.

The following command loads text data (employees.unl) into the EMPLOYEES table of the mf_personnel database. The employees.rrd file provides the record definition for the data in employees.unl

```
$ RMU/LOAD/RECORD_DEFINITION=(FILE=employees.rrd, FORMAT=TEXT) -
_ $ mf_personnel EMPLOYEES employees.unl
```

You can generate an appropriate .rrd file for the preceding example by issuing the following command:

```
$ RMU/UNLOAD/RECORD_DEFINITION=(FILE=employees.rrd, FORMAT=TEXT) -
_ $ mf_personnel EMPLOYEES unload.unl
```

- Delimited text data files

To load delimited text data files (.unl) you must specify the Record_Definition qualifier with the with the Format=Delimited_Text option.

The following command loads delimited text data (employees.unl) into the EMPLOYEES table of the mf_personnel database. The employees.rrd file describes the format of employees.unl

```
$ RMU/LOAD/RECORD_DEFINITION=(FILE=employees.rrd, -
_ $ FORMAT=DELIMITED_TEXT, TERMINATOR="#") -
_ $ mf_personnel EMPLOYEES employees.unl
```

You can generate an appropriate .rrd file for the preceding example by issuing the following command:

```
$ RMU/UNLOAD/RECORD_DEFINITION=(FILE=employees.rrd, -
_ $ FORMAT=DELIMITED_TEXT) mf_personnel EMPLOYEES unload.unl
```

- Binary data files

To load binary data files, you must ensure that the records you load match the record definition in both size and data type. The records must all have the same length and the data in each record must fill the entire record. If the last field is character data and the information is shorter than the field length, the remainder of the field must be filled with spaces. You cannot load a field that contains data stored in packed decimal format.

1.28 RMU Load Command

The following command loads binary data (employees.unl) into the EMPLOYEES table of the mf_personnel database. The employees.rrd file describes the format of employees.unl.

```
$ RMU/LOAD/RECORD_DEFINITION=(FILE=employees.rrd) mf_personnel -
_ $ EMPLOYEES employees.unl
```

You can generate an appropriate .rrd file for the preceding example by issuing the following command:

```
$ RMU/UNLOAD/RECORD_DEFINITION=(FILE=employees.rrd) mf_personnel -
_ $ EMPLOYEES unload.unl
```

- Specially structured binary files that include both data and metadata.

To load the specially structured binary files (created by the RMU Unload command without the Record_Definition qualifier) you must specify the file (.unl) created by the RMU Unload command.

The following command loads the binary data contained in the employees.unl file into the EMPLOYEES table of the mf_personnel database. The record definition information is contained within the binary .unl file.

```
$ RMU/LOAD MF_PERSONNEL EMPLOYEES employees.unl
```

This specially structured employees.unl file is created with the following RMU Unload command:

```
$ RMU/UNLOAD MF_PERSONNEL EMPLOYEES employees.unl
```

- Security audit journal files

To load the records from a security audit journal file maintained by the OpenVMS operating system, you must decide whether to load records into the same database for which security audit journal records are being recorded or to load them into a separate database. In either case you do not need to specify a record definition file; use of the Audit qualifier indicates to Oracle RMU that the record definition is that of the security audit journal file.

The following command loads the records from the security audit journal file (with a logical name of SECURITY_AUDIT) for the mf_personnel database into the AUDIT_TABLE table of the mf_personnel database:

```
$ RMU/LOAD/AUDIT MF_PERSONNEL.RDB AUDIT_TABLE -
_ $ SECURITY_AUDIT
```

1.28 RMU Load Command

This example loads the records from the security audit journal file (with a logical name of SECURITY_AUDIT) for the mf_personnel database into the AUDIT_TABLE table of the audit database:

```
$ RMU/LOAD/AUDIT=DATABASE_FILE=MF_PERSONNEL.RDB AUDIT.RDB -  
_ $ AUDIT_TABLE SECURITY_AUDIT
```

See the Usage Notes for more detailed information on loading security audit journal records and the file name of the security audit journal.

In all cases where you specify a record definition file (.rrd), the record definition file and the database definition of the table being loaded must match in the number of specified fields and the data type of each field. If the data you want to load has more fields than the database table definition specifies, you can still load the data, but you must use the FILLER keyword with the field definition in your .rrd file to represent the additional field. See Example 15 in the Examples section.

By default, the table specified in the RMU Load command is reserved for PROTECTED WRITE.

Table 1–11 shows the data type conversions that can occur while you are performing a load or unload operation.

Table 1–11 Data Type Conversions Performed by Oracle Rdb

Original Data Type	New Data Type
TINYINT	INTEGER, QUADWORD, SMALLINT, FLOAT, DOUBLE PRECISION, VARCHAR, CHAR
SMALLINT	INTEGER, QUADWORD, FLOAT, DOUBLE PRECISION, VARCHAR, CHAR
INTEGER	SMALLINT, QUADWORD, FLOAT, DOUBLE PRECISION, VARCHAR, CHAR
QUADWORD	SMALLINT, INTEGER, FLOAT, DOUBLE PRECISION, VARCHAR, CHAR
FLOAT	DOUBLE PRECISION, CHAR, and VARCHAR
DOUBLE PRECISION	FLOAT, CHAR, and VARCHAR
DATE	CHAR or VARCHAR
TIME	CHAR or VARCHAR
TIMESTAMP	CHAR or VARCHAR

(continued on next page)

1.28 RMU Load Command

Table 1–11 (Cont.) Data Type Conversions Performed by Oracle Rdb

Original Data Type	New Data Type
INTERVAL	CHAR or VARCHAR
CHAR	FLOAT, DOUBLE PRECISION, DATE, TIME, TIMESTAMP, INTERVAL, VARCHAR, SMALLINT, INTEGER, or QUADWORD

See the *Oracle Rdb SQL Reference Manual* for a description of these data types.

Command Parameters

root-file-spec

The file specification for the database root file into which the table will be loaded. The default file extension is `.rdb`.

table-name

The name of the table to be loaded, or its synonym.

When the Audit qualifier is specified, the `table-name` parameter is the name of the table in which you want the security audit journal records to be loaded. If the table does not exist, the RMU Load command with the Audit qualifier creates the table and loads it. If the table does exist, the RMU Load command with the Audit qualifier loads the table.

input-file-name

The name of the file containing the data to be loaded. The default file extension is `.unl`.

When the Audit qualifier is specified, the `input-file-name` parameter is the name of the journal containing the audit record data to be loaded. The default file extension is `.AUDIT$JOURNAL`. You can determine the name of the security audit journal by using the `DCL SHOW AUDIT/JOURNAL` command.

Command Qualifiers

Audit[=Database_File=db-name]

Allows you to load a database's security audit records from an OpenVMS security audit journal into one of the following:

1.28 RMU Load Command

- A table in the database being audited
Specify the Audit qualifier without the Database_File option to indicate that you want the security audit records to be loaded into the database specified with the root-file-spec parameter.
- A table in a different database than the one being audited
Specify the Audit=Database_File=db-name qualifier to indicate that you want to security audit records for the database specified with the root-file-spec command parameter to be loaded into the database specified with the db-name option parameter.

If you specify the Audit qualifier, you cannot specify the Fields or Trigger_Relations qualifiers.

In addition you cannot specify the Audit qualifier with a parallel load operation. If you attempt to do so, Oracle RMU issues a warning and performs a single-executor load operation.

Buffers=n

Specifies the number of database buffers used for storing data during the load operation. If no value is specified, the default value for the database is used. (The default value for the database is defined by the logical name RDM\$BIND_BUFFERS, or if the logical is not defined, can be determined by using the RMU Dump command with the Header qualifier. The RDM\$BIND_BUFFERS logical name, if defined, overrides the value displayed with the RMU Dump command.) Fewer I/O operations are required if you can store as much data as possible in memory when many indexes or constraints are defined on the target table. Therefore, specify more buffers than allowed by the default value to increase the speed of the load operation.

See the *Oracle Rdb7 Guide to Database Performance and Tuning* for detailed recommendations on setting the number of database buffers.

Commit_Every=n

Specifies the frequency with which Oracle Rdb commits the data being loaded. For a single-executor load operation, Oracle Rdb commits the data after every *n* records that are stored. The default is to commit only after all records have been stored.

For a parallel load operation, the Commit_Every qualifier applies separately to each of the executors (processes) used. For example, if five parallel processes are running, and the Commit_Every=2 qualifier is specified, Oracle RMU commits data for each process after it has stored 2 records. This means that if the Commit_Every=1000 qualifier is specified when you load one million

1.28 RMU Load Command

records with 10 parallel processes, the .ruj files will store up to 10,000 rows of before-image data.

If you specify the `Defer_Index_Updates` qualifier and a high value for the `Commit_Every` qualifier, memory requirements are high. See the description of the `Defer_Index_Updates` qualifier for details. Commit operations may occur more frequently than you specify under certain conditions. See the description of the `Defer_Index_Updates` qualifier for details.

To determine how frequently you should commit data, decide how many records you are willing to reload if the original load operation fails. If you use the `Statistics=On_Commit` qualifier, you receive a message indicating the number of records loaded at each commit operation. Then, if a failure occurs, you know where to resume loading.

If you specify the `Place` qualifier and a failure occurs, resume loading at the point of the previous commit, instead of the record number of the last successful commit. The `Place` qualifier restructures the .unl file prior to loading, so the record number on which the load operation failed does not correspond to the same number in the original .unl file.

Constraints[=Deferred]

Noconstraints

Specifies when or if constraints are evaluated for data being loaded. If you specify the `Constraints` qualifier, constraints are evaluated as each record is loaded. If you specify the `Noconstraints` qualifier, constraints are not evaluated at all during the load operation. If you specify the `Constraints=Deferred` qualifier, constraints are evaluated after all data from the input file has been loaded.

The default is the `Constraints` qualifier.

Oracle Corporation recommends that you accept the default for most load operations. The `Noconstraints` and `Constraints=Deferred` qualifiers are useful when load performance is your highest priority, you fully understand the constraints defined for your database, and you are familiar enough with the input data to be fairly certain that loading that data will not violate constraints; then you might use these qualifiers as follows:

- `Constraints=Deferred`

This qualifier is particularly useful for improving performance when you are loading data into a new table. Oracle Corporation strongly recommends that you issue an `RMU Verify` command with the `Constraints` qualifier when the load operation has completed. Note, however, that issuing the `RMU Verify` command after the load operation has completed takes about the same amount of time that would have been spent had you specified the

1.28 RMU Load Command

RMU Load command with the Constraints qualifier. In other words, by specifying the Constraints=Deferred qualifier, you are only delaying when the constraint verification will take place.

- **Noconstraints**
This qualifier is particularly useful when you are performing a parallel load operation with the `Defer_Index_Updates` qualifier. Oracle Corporation strongly recommends that you issue an RMU Verify command with the Constraints qualifier when the load operation has completed. Note, however, that when you issue the RMU Verify command with the Constraints qualifier, *all* rows in the table are checked for constraint violations, not just the rows that are loaded.

Consider the following before issuing an RMU Load command with the `Noconstraints` or `Constraints=Deferred` qualifier:

- If a table is populated with data prior to a load operation, it is less expensive to check constraints on each record as it is being loaded, than to verify constraints on the entire table after the set of new records has been loaded. For example, assume you load 200 new records into a table that currently holds 2,000 records and one constraint is defined on the table. If you verify constraints as the records are being loaded, constraint validation is performed 200 times. If you wait and verify constraints after the load operation completes, constraint verification must be performed for 2,200 records
- If an RMU Verify command reveals that constraint violations occurred during the load operation, you must track down those records and either remove them or make other modifications to the database to restore the data integrity. This can be a time-consuming process.

Also consider a situation where all of the following are true:

- You perform a parallel load operation
- You specify the Constraints qualifier
- The table into which you are loading data has a constraint defined on it
- The constraint defined on the table was defined as deferred
- Constraint evaluation fails during the load operation

In a case such as the preceding, you can not easily determine which rows were loaded and which were not. Therefore Oracle Corporation recommends that if deferred constraints are defined on a table, then you should also specify the `Constraints=Deferred` qualifier in your parallel load command. When you follow this recommendation, the records that violate the constraint are stored

1.28 RMU Load Command

in the database. When the load operation completes, you can remove from the database those records that violate the constraint.

See Example 6 in Section 1.64 for an example of the steps to take if an RMU Verify command reveals that an RMU Load command has stored data that violates constraints into your database.

Corresponding

Loads fields into a table from the .unl file by matching the field names in the .rrd file to the column names in the table. The Corresponding qualifier makes it more convenient to unload, restructure, and reload a table.

For example, if the columns in the table appear in the order: EMPLOYEE_ID, LAST_NAME, FIRST_NAME, but the data in your .unl file appears in the order: EMPLOYEE_ID, FIRST_NAME, LAST_NAME, and your .rrd file lists the fields in the order: EMPLOYEE_ID, FIRST_NAME, LAST_NAME, you can use the Corresponding qualifier to load the data in your .unl file correctly. (You could also use the Fields qualifier to accomplish the same task, but this can get tedious if there are numerous fields.)

The .unl file must contain data for each field in the database into which it is being loaded; if it does not, you should use the Fields qualifier.

If the Corresponding qualifier is omitted, the RMU Load command loads the data into database fields by the ordinal position in which they appear in the .unl, not by the column name described in the .rrd file.

The Corresponding qualifier cannot be used with either the Fields or Audit qualifiers.

Defer_Index_Updates

Nodefer_Index_Updates

The Defer_Index_Updates qualifier specifies that non-unique indexes (other than those that define the placement information for data in a storage area) will not be rebuilt until commit time.

Use of this qualifier results in less I/O and fewer lock conflicts than when index builds are not deferred, but results in a total failure of a load operation if *any* lock conflicts are encountered. In such a case, the entire load operation is rolled back to the previous commit and you must repeat the load operation. (Record insertion recommences at the beginning of the input file). For this reason, you should only use the Defer_Index_Updates qualifier when all of the following are true:

- You specify the Noconstraints qualifier (or you have dropped constraints, or no constraints are defined on the table).

1.28 RMU Load Command

- You have dropped triggers from the table (or triggers are not defined for the table).
- No other users are accessing the table being loaded.

Also be aware that required virtual memory can be quite large when you defer index updates. Required virtual memory is directly proportional to the following:

- The length of the Ikeys in the indexes being deferred
- The number of indexes being deferred
- The value for n specified with the Commit_Every qualifier

You can *estimate* the amount of virtual memory required for each deferred index using the following formula, where:

- n = the value specified with the Commit_Every qualifier
- I = (length of the Ikey + 50)

$n * (I * \text{number_deferred_ikeys})$

The Nodefer_Index_Updates qualifier is the default. When you specify the Nodefer_Index_Updates qualifier (or accept the default), both the indexes that define the placement information for data in a storage area and any other indexes defined on the table being loaded are rebuilt at verb time.

This can result in a managed deadlock situation when the Parallel qualifier is specified. The following describes such a scenario:

- Executor_1 locks index node A in exclusive mode
- Executor_2 locks index node B in exclusive mode
- Executor_1 requests a lock on index node B
- Executor_2 requests a lock on index node A

In such a situation, Oracle Rdb resolves the deadlock by directing one of the executors to commit the data it has already stored. This resolves the deadlock situation and the load operation continues.

Execute

Noexecute

The Execute and Noexecute qualifiers are used with the List_Plan qualifier to specify whether or not the generated plan file is to be executed. The Noexecute qualifier specifies that the plan file should be created but should not be executed. Regardless of whether you use the Noexecute or Execute qualifier (or

1.28 RMU Load Command

accept the default), Oracle RMU performs a validity check on the RMU Load command you specify.

The validity check determines such things as whether the specified table is in the specified database, the .rrd file (if specified) matches the table, and that the number of columns specified with the Fields qualifier matches the number of columns in the .unl file. The validity check does not determine such things as whether your process and global page quotas are sufficient.

By default, the plan file is executed when an RMU Load command with the List_Plan qualifier is issued.

Fields=(column-name-list)

Specifies the column or columns of the table to be loaded into the database. If you list multiple columns, separate the column names with a comma, and enclose the list of column names within parentheses. Also, this qualifier specifies the order of the columns to be loaded if that order differs from the order defined for the table. The number and data type of the columns specified must agree with the number and data type of the columns in the .unl file. The default is all columns defined for the table in the order defined.

If you specify an options file in place of a list of columns, and the options file is empty, the RMU Load command loads all fields.

List_Plan[=output-file]

Specifies that Oracle RMU should generate a plan file and write it to the specified output file. A plan file is a text file that contains all the qualifiers specified on the RMU Load command line. In addition, it specifies the executor names (if you are performing a parallel load operation), the directory for the .ruj files, the exception files, and the file created by the Place_Only qualifier (if specified).

Oracle RMU validates the Oracle RMU command prior to generating the plan file to ensure that an invalid plan file is not created. (This is true regardless of whether or not you specify the Noexecute qualifier.) For example, the following command is invalid and returns an error message because it specifies conflicting qualifiers (Corresponding and Fields):

```
$ RMU/LOAD/RECORD_DEF=FILE=NAMES.RRD/CORRESPONDING -
_ $ /FIELDS=(LAST_NAME, FIRST_NAME)/LIST_PLAN=my_plan.plan -
_ $ MF_PERSONNEL.RDB EMPLOYEES NAMES.UNL
%RMU-F-CONFLSWIT, conflicting options CORRESPONDING and FIELDS...
```

See the description of the Execute qualifier for a description of what items are included when Oracle RMU validates the RMU Load command. See the Examples section for a complete example and description of a plan file.

1.28 RMU Load Command

You can use the generated plan as a starting point for building a load operation that is tuned for your particular configuration. The output file can be customized and then used with subsequent load operations as the parameter to the RMU Load Plan command. See Section 1.29 for details.

If you want to create only a load plan file and do not want to execute the load plan when the RMU Load command is issued, specify the `Noexecute` qualifier. When you specify the `Noexecute` qualifier, you must specify a valid Oracle RMU command.

One way to prototype a plan file prior to creating a potentially very large `.unl` file is to specify the `List_Plan` qualifier and the `Noexecute` qualifier along with a valid record definition (`.rrd`) file and an *empty* `.unl` file on the RMU Load command line. The `.rrd` file contains the information Oracle RMU needs to perform the validation of the plan file; however, because data is not loaded when you specify the `Noexecute` qualifier, Oracle RMU does not attempt to load the `.unl` file. Note, however, that you cannot specify the `Fields` qualifier when using this strategy. (When you specify the `Fields` qualifier, Oracle RMU checks to make sure the number of columns specified with the `Fields` qualifier match the number of columns specified in the `.unl` file.)

If you do not specify a file extension, the default file extension for the plan file is `.plan`.

Log_Commits

Nolog_Commits

Causes a message to be printed after each commit operation. In the case of a parallel load, a message is printed after each executor commits.

The default is the `Nolog_Commits` qualifier, where no message is printed after individual commit operations. The `Nolog_Commits` qualifier does, however, cause a commit operation total to be printed after the operation completes or generates an error.

Match_Name=table-name

Nomatch_Name

Specifies the table name to be read. Tables exported by SQL into an interchange file can be individually loaded into a database.

The default behavior of the RMU Load command is to locate and load the first set of table data in the unload file. If this is not the table you want, you can use the `Match_Name` qualifier to specify a different table name. If the `Match_Name` qualifier is used without a table-name, Oracle RMU assumes the name of the table being loaded is also the name of the table in the source data file. The default is the `Nomatch_Name` qualifier.

1.28 RMU Load Command

Parallel[=(options)]

Specifies a parallel load operation. A parallel load operation is especially effective when you have large partitioned tables that do not contain segmented strings and for which no constraints or triggers are defined.

If you specify the Parallel qualifier without any options, your load operation is assigned one executor and four communications buffers for that executor. A communications buffer is used for communications between your process and the executors.

If you want to assign additional executors or communications buffers, or both, use one or both of the following options:

- **Buffer_Count=n**

Allows you to specify the number of *communications* buffers assigned to each executor in a parallel load operation.

Do not confuse this with the **Buffers=n** qualifier. The **Buffers=n** qualifier specifies the number of *database* buffers to use during the load operation.

- **Executor_Count=n**

Allows you to specify the number of worker processes to be assigned to the load operation. Ideally, the number of executors should be equal to the number of table partitions. You should not assign a greater number of executors than the number of table partitions. If a table is randomly or vertically partitioned, Oracle RMU creates only one executor, regardless of the number you specify.

If you have the OpenVMS DETACH privilege, executors are created as detached processes. Otherwise, executors are created as subprocesses of your process.

At the end of each load operation, Oracle RMU displays summary statistics for each executor in the load operation and the main process. Look at the "Idle time" listed in the statistics at the end of the job to detect data skew and look at "Early commits" to detect locking contention.

If some executors have a large amount of idle time, you likely have data that is skewed. Ideally, data loaded with the Parallel qualifier should appear in random order within the .unl file. Data that is already in partition order when you attempt to perform a parallel load operation results in high idle time for each executor and thus defeats the advantages of a parallel load operation.

The summary statistics also list the number of records read from the input file, the number of data records stored, and the number of data records rejected. In most cases, the number of data records rejected plus the number of data

1.28 RMU Load Command

records stored equals the number of data read from the input file. However, under the following circumstances this equation does not hold:

- The parallel load operation aborts due to a duplicate record that is not allowed.
- You did not specify an exception file.

Similarly if a load operation aborts due to a record in the input file being improperly delimited for a delimited text load, the records rejected plus the records stored do not equal the number of records read from the input file.

You cannot use a parallel load operation to load list data (segmented string) records or security audit records. If you specify a parallel load operation and attempt to load list data or security audit records, Oracle RMU returns a warning and performs a single-process (non-parallel) load operation.

Place

Noplace

Sorts records by target page number before they are stored.

The Place qualifier automatically builds an ordered set of database keys (dbkeys) when loading data and automatically stores the records in dbkey order, sequentially, page by page. During a parallel load operation, each worker executor builds its own ordered set of dbkeys.

The number of work files used by the RMU Load command is controlled by the RDMS\$BIND_SORT_WORKFILES logical name. The allowable values are 1 through 10 inclusive, with a default value of 2. The location of these work files can be specified with device specifications, using the SORTWORK n logical name (where n is a number from 0 to 9). See the OpenVMS documentation set for more information on using SORT/MERGE. See the *Oracle Rdb7 Guide to Database Performance and Tuning* for more information on using these Oracle Rdb logical names.

A significant performance improvement occurs when the records are stored by means of a hashed index. By using the Commit_Every qualifier with the Place qualifier, you can specify how many records to load between COMMIT statements. Performance may actually decrease when records are stored by means of a sorted index.

The default is the Noplace qualifier.

Record_Definition=({File | Path}=name[,options]**)**

Specifies the RMS record definition or the data dictionary record definition to be used when data is loaded into the database. Use the File=name parameter to specify an RMS record definition file; use the Path=name parameter to

1.28 RMU Load Command

specify that the record definition be extracted from the data dictionary. (If the record definition in the data dictionary contains variants, Oracle RMU will not be able to extract it.)

The default file extension for the `File=name` parameter is `.rrd`. The syntax for the `.rrd` file is similar to that used by the Common Dictionary Operator (CDO) interface for the data dictionary. You must define columns before you can define rows. You can place only one column on a line. You can create a sample `.rrd` file by using the RMU Unload command with the `Record_Definition` qualifier. You must ensure that the record definition in the `.rrd` file and the actual data are consistent with each other. Oracle Rdb does not check to see that data types in the record definition and the data match. See Appendix A and the *Oracle Rdb Guide to Database Design and Definition* for more information about the format of the `.rrd` file.

You must specify either the `File=name` or `Path=name` parameter.

The options available are:

- `Exception_File=exception-file`

Allows you to write unloadable records to a single exception file for a single-process load operation and into multiple exception files for a parallel load operation. If you generate a load plan for a parallel load operation, each executor is assigned its own exception file. In this case, the exception-file name you specify is given a different file extension for each executor.

While Oracle RMU is loading data from an RMS file, if an exception file is specified, then under certain circumstances an invalid record in the input file does not cause the RMU Load command to abort. Instead, Oracle RMU creates the exception file (or files), writes the unloadable record into this exception file (or files), and continues loading the remaining records. This process occurs only if the data is invalid on the actual insert, due to index, constraint, or trigger errors. If the record has an invalid format in the RMS file (for example, a missing delimiter), the exception file is not used, and the load process aborts.

At the end of the load operation, you can process the exception file (or files) to correct any problems, and then reload directly from the exception file or files. The load operation gives an informational message for each of the unloadable records and also gives a summary of the number of records stored and the number of records rejected.

All records that could not be loaded will be written into the file or files as specified with the argument to the `Exception_File` option. The default file extension for the exception file is `.unl` for single-process loads; for parallel loads the default extension is `EXC_n`, where `n` corresponds to the executor number assigned by Oracle RMU. The exception file or files are created

1.28 RMU Load Command

only if there are unloadable records. If the `Exception_File` option is not specified, no exception files are created, and the load operation aborts at the first occurrence of an exception.

However, note that if the `Defer_Index_Updates` qualifier is specified, and a constraint violation or lock conflict occurs, the load operation aborts when it attempts to commit the transaction.

If the `Defer_Index_Updates` qualifier is not specified, records that cause a constraint violation are written to the exception file or files and the load operation continues loading the remaining records.

- `Format=Text`

If you specify the `Format=Text` option, Oracle RMU converts all data to printable text before loading it.

- If you do not specify the `Format` option, then Oracle RMU expects to load a fixed-length binary flat file. The data type of the fields must be specified in the `.rrd` file.

- `Format=(Delimited_Text [,delimiter-options])`

If you specify the `Format=Delimited_Text` option, the `.rrd` file contains only text fields and specifies the maximum length of the columns in the file containing delimited ASCII text. The column values that are longer than those specified in the `.rrd` file are truncated.

Note that DATE VMS types must be specified in the collatable time format, which is `yyyymmddhhmmsscc`. For example, March 20, 1993 must be specified as: `1993032000000000`.

Unless you specify the `Format=Delimited_Text` option, delimiters are regarded as part of the data by Oracle RMU. Example 13 in the Examples section demonstrates the `Format=Delimited_Text` option. Delimiter options (and their default values if you do not specify delimiter options) are as follows. Note that with the exception of the `Prefix` and `Suffix` delimiter options, the values specified must be unique. The `Prefix` and `Suffix` values can be the same value as each other, but not the same as other delimiter options. The `Null` string must also be unique.

- `Prefix=string`

Specifies a prefix string that begins any column value in the ASCII input file. If you omit this option, the column prefix is assumed to consist of a quotation mark (").

- `Separator=string`

1.28 RMU Load Command

Specifies a string that separates column values of a row. If you omit this option, the column separator is assumed to consist of a single comma (,).

– Suffix=string

Specifies a suffix string that ends any column value in the ASCII input file. If you omit this option, the column suffix is assumed to consist of a quotation mark (").

– Terminator=string

Specifies the row terminator that completes all the column values corresponding to a row. If you omit this option, the row terminator is assumed to be the end of the line.

– Null=string

Specifies a string, which when found in the input record, is stored as NULL in the database column. This option is only valid when the Delimited_Text option is specified also.

The Null option can be specified *on the command line* as any one of the following:

- * A quoted string
- * An empty set of double quotes (" ")
- * No string

If provided, the string that represents the null character must be quoted on the Oracle RMU command line, however, it *must not* be quoted in the input file. You cannot specify a blank space or spaces as the null character.

If the final column or columns of a record are to be set to NULL, you only have to specify data for the column up to the last non-null column.

See the Examples section for an example of each of these methods of storing the NULL value.

Note

The values of each of the strings specified in the delimiter options must be enclosed by quotation marks. Oracle RMU strips these quotation marks while interpreting the values. If you want to specify a quotation mark (") as a delimiter, specify a string of four quotation marks. Oracle RMU interprets four quotation marks as your request to use one quotation mark as a delimiter. For example, Suffix = "" "".

Oracle RMU reads the quotation marks as follows:

1.28 RMU Load Command

- The first quotation mark is stripped from the string.
- The second and third quotation marks are interpreted as your request for one quotation mark (") as a delimiter.
- The fourth quotation mark is stripped. This results in one quotation mark being used as a delimiter.

Furthermore, if you want to specify a quotation mark as part of the delimiter string, you must use two quotation marks for each quotation mark that you want to appear in the string. For example, `Suffix = "**" " "**` causes Oracle RMU to use a delimiter of `**" "**`.

A delimiter of blank spaces enclosed in quotes is not valid.

- `Place_Only=sorted-placement-file`

Allows you to sort the input file and create an output file sorted in Placement order.

The input file can first be sorted into Placement order by using the `Place_Only` option. The resultant file can then be loaded with the `Commit_Every` qualifier to gain the required efficiency. Do not use this option with a parallel load operation; parallel load operations perform best when the input file is not sorted.

The `Place_Only` option cannot be used with either the `Commit_Every` qualifier or the `Exception_File` option (data is not being stored in the database). However, the `Place_Only` option requires the `Place` qualifier be specified (to sort the data).

The placement-sorted output file has the default file extension of `.unl`.

Unless you specify the `Null` option (with the `Format=Delimited_Text` parameter of the `Record_Definition` qualifier), any null values stored in the rows of the tables being loaded are not preserved. Therefore, use the `Null` option if you want to preserve null values stored in tables and you are moving data within the database or between databases.

See the examples in Section 1.62 for more information.

Rms_Record_Def=({File=name | Path=name}[,options])

Synonymous with the `Record_Definition` qualifier. See the description of the `Record_Definition` qualifier.

1.28 RMU Load Command

Restricted_Access

NoRestricted_Access

Allows a single process to load data and enables some optimizations available only when restricted access is in use. The default is `NoRestricted_Access`.

If you are loading a table from an RMU Unload file which contains `LIST OF BYTE VARYING` data, the `Restricted_Access` qualifier reserves the `LIST` areas for `EXCLUSIVE` access. This reduces the virtual memory used by long transactions during a load operation and also eliminates I/O to the snapshot files for the `LIST` storage areas.

The `Restricted_Access` and `Parallel` qualifiers are mutually exclusive and cannot be specified together on the same RMU Load command line or within a plan file. While RMU Load is running with the `Restricted_Access` qualifier specified, no other user can attach to the database.

Row_Count=n

Specifies that Oracle Rdb buffer multiple rows between the Oracle Rdb server and the RMU Load process. The default for *n* is 500 rows; however, this value should be adjusted based on working set size and length of loaded data. Increasing the row count may reduce the CPU cost of the load operation. For remote databases, this may significantly reduce network traffic for large volumes of data because the buffered data can be packaged into larger network packets.

The minimum value you can specify for *n* is 1. The default row size is the value specified for the `Commit_Every` qualifier or 500, whichever is smaller.

Skip=n

Noskip

Ignores the first *n* data records in the input file. Use this qualifier in conjunction with the `Commit_Every` qualifier when restarting an aborted load operation. An aborted load operation displays a message indicating how many records have been committed. Use this value for *n*. If you specify a negative number, you receive an error message. If you specify a number greater than the number of records in the file, you receive an error message stating that no records have been stored. If you do not specify a value, you receive an error message stating that there is a missing keyword value.

Using the `Skip` qualifier to restart an aborted parallel load operation is rarely useful. Because records are sorted by the controller for each executor involved in the parallel load, there are usually multiple sections of loaded and unloaded records in the input file. Unless you are very familiar with the data you are loading and how it is sorted by the controller, you risk loading some records

1.28 RMU Load Command

twice and not loading other records at all, if you use the Skip qualifier when restarting an aborted parallel load operation.

The default is the Noskip qualifier.

Statistics=(stat-opts)

Specifies that statistics are to be displayed at regular intervals or each time a transaction commits, or both, so that you can evaluate the progress of the load operation.

The stat-opts are the options you can specify with this qualifier, namely: Interval=*n*, On_Commit, or both. If the Statistics qualifier is specified, you must also specify at least one option.

When the Statistics=(Interval=*n*) qualifier is specified, Oracle RMU prints statistics every *n* seconds. The minimum value for *n* is 1.

When the Statistics=(On_Commit) qualifier is specified, Oracle RMU prints statistics each time a transaction is committed.

If you specify both options, Statistics=(Interval=*n*, On_Commit), statistics are displayed every *n* seconds and each time a transaction commits.

The displayed statistics include:

- Elapsed time
- CPU time
- Buffered I/O
- Direct I/O
- Page faults
- Number of records loaded when the last transaction was committed
- Number of records loaded so far in the current transaction
- If the Record_Definition=Exception_File option is also specified, the following statistics are displayed also:
 - Number of records rejected when the last transaction was committed
 - Number of records rejected so far in the current transaction
- If the Parallel qualifier is specified also, the following statistics are displayed also:
 - Number of extra commits performed by executors

1.28 RMU Load Command

Extra commits are caused when the Oracle RMU directs your process or the executors to commit a transaction earlier than usual to avoid a hung load operation. For example, if one executor is holding, but no longer needs a lock that another executor requires, Oracle RMU directs the first executor to commit its current transaction. By directing an executor or executors to commit a transaction earlier than usual, the locks under contention are released and the load operation can proceed.

- The total number of executors
- The number of executors that are initializing, idle, terminated, sorting, storing, committing, or executing

At any time during the load operation, you can press Ctrl/T to display the current statistics.

Transaction_Type=share-mode

Specifies the share mode for the load operation. The following share modes are available:

- Batch_Update
- Exclusive
- Protected
- Shared

You must specify a value if you use the Transaction_Type qualifier. If you do not specify the Transaction_Type qualifier, the default share mode is Protected.

If you specify a parallel load operation (with the Parallel qualifier), and constraints are defined on the table you are loading, Oracle Corporation recommends that you specify the Shared share mode, or drop the constraints prior to starting a parallel load operation, or specify the Noconstraints qualifier. See the Usage Notes for details.

Trigger_Relations[=(table-name-list)]

Nottrigger_Relations

You can use the Trigger_Relations qualifier in three ways:

- Trigger_Relations=(table-name-list)
Specifies the tables to be reserved for update. Using this qualifier, you can explicitly lock tables that are updated by triggers in store operations. If you list multiple tables, separate the table names with a comma, and enclose the list of table names within parentheses.

1.28 RMU Load Command

- **Trigger_Relations**
If you omit the list of table names, the tables updated by triggers are locked automatically as required. This is the default.
- **NoTrigger_Relations**
Disables triggers on the target table. This option requires DROP privilege on the table being loaded. You cannot specify a list of table names with this option.

If you specify a parallel load operation (with the Parallel qualifier), and triggers are defined on the table you are loading, Oracle Corporation recommends that you specify the Shared share mode or drop the triggers prior to starting a parallel load operation. See the Usage Notes for details.

The Trigger_Relations qualifier can be used with indirect file references. See Section 1.3 for more information.

Usage Notes

- To use the RMU Load command for a database, you must have the RMU\$LOAD privilege in the root file access control list (ACL) for the database or the OpenVMS SYSPRV or BYPASS privilege. The appropriate Oracle Rdb privileges for accessing the database tables involved are also required.
- To use the RMU Load command with the Audit qualifier, you must have both of the following:
 - The RMU\$SECURITY privilege in the root file ACL for the database whose security audit records are being loaded
 - The RMU\$LOAD privilege in the root file ACL for the database into which these security audit records are being loaded

If you do not have both of the privileges described in the preceding list, you must have the OpenVMS SYSPRV or BYPASS privilege.

- You can unload a table from a database structured under one version of Oracle Rdb and load it into the same table of a database structured under another version of Rdb. For example, if you unload the EMPLOYEES table from a mf_personnel database created under Oracle Rdb V6.0, you can load the generated .unl file into an Oracle Rdb V7.0 database. Likewise, if you unload the EMPLOYEES table from a mf_personnel database created under Oracle Rdb V7.0, you can load the generated .unl file into an Oracle Rdb V6.1 database. This is true even for specially formatted binary files

1.28 RMU Load Command

(created with the RMU Unload command without the Record_Definition qualifier). The earliest version into which you can load a .unl file from another version is Oracle Rdb V6.0.

- The following list provides information on parallel load operations:
 - Specify no more executors (with the Executor_Count option to the Parallel qualifier) than storage areas defined for the table you are loading.
 - You cannot use a parallel load operation to load list data (segmented string) records or security audit records. If you specify a parallel load operation and attempt to load list data or security audit records, Oracle RMU returns a warning and performs a single-executor load operation.
 - Oracle Corporation recommends that you specify a shared mode transaction type or specify the Noconstraints qualifier and drop triggers during a parallel load operation; otherwise, constraints and triggers defined on the table you are loading can cause lock conflicts among the parallel load executors.
 - If you are using parallel load and hashed indexes, do not sort the data prior to loading it. Instead, use the Place qualifier to the RMU Load command to sort the data as it is loaded. (The Place qualifier is useful for hashed indexes, not sorted.)
- The following list provides information on loading security audit journals:
 - Loading security audit journals into a database other than that which is being audited

When you load the security audit journals recorded for one database into another database, you specify the database that is being audited as a parameter to the Audit=Database_File qualifier, and you specify the database into which these security audit records should be loaded with the root-file-spec parameter to the Oracle RMU command.

For instance, the following example loads the security audit journal records for the mf_personnel database into the MFP_AUDIT table of the audit_db database. Note that SECURITY_AUDIT is a logical name that points to the actual security audit journal file.

```
$ RMU/LOAD/AUDIT=DATABASE_FILE=MF_PERSONNEL AUDIT_DB -  
_ $ MFP_AUDIT SECURITY_AUDIT
```

When you issue the preceding RMU Load command, the audit_db database must exist. However, the RMU Load command creates the MFP_AUDIT table in the audit_db database and appropriately defines the columns for the MFP_AUDIT database.

1.28 RMU Load Command

In other words, the following SQL statement satisfies the minimum requirements for the audit_db database to be used correctly by the preceding RMU Load command:

```
SQL> CREATE DATABASE FILENAME audit_db.rdb;
```

Note that there is no field in the audit record loaded by Oracle RMU to indicate the source database for the records. Therefore, it is not wise to mix auditing records from different databases in the same table. Instead, auditing information for different databases should be loaded into separate tables.

- Security audit journal file name

The name of the security audit journal file depends on the version of the operating system software you are running and on the hardware platform, as follows:

- * SYS\$MANAGER:SECURITY.AUDIT\$JOURNAL for OpenVMS Alpha V6.1 and later and OpenVMS VAX V6.0 and later
- * SYS\$MANAGER:SECURITY_AUDIT.AUDIT\$JOURNAL for OpenVMS Alpha prior to V6.1 and OpenVMS VAX V5.5 and earlier.

- Loading security audit journals into the database being audited

The Oracle Rdb table into which you load the security audit journal records should be defined with the columns shown in Table 1–12 under the column marked Oracle Rdb Column Name so that the audit journal records can be loaded successfully into the table. If the table does not exist, the RMU Load Audit command creates it with the columns shown in Table 1–12 under the column marked Oracle Rdb Column Name. You can give the table any valid name.

- Table 1–12 lists the column names created by the RMU Load command with the Audit qualifier.

1.28 RMU Load Command

Table 1–12 Columns in a Database Table for Storing Security Audit Journal Records

Oracle Rdb Column Name	SQL Data Type and Length
AUDIT\$EVENT	CHAR 16
AUDIT\$SYSTEM_NAME	CHAR 15
AUDIT\$SYSTEM_ID	CHAR 12
AUDIT\$TIME_STAMP	CHAR 48
AUDIT\$PROCESS_ID	CHAR 12
AUDIT\$USER_NAME	CHAR 12
AUDIT\$TSN	CHAR 25 ¹
AUDIT\$OBJECT_NAME	CHAR 255
AUDIT\$OBJECT_TYPE	CHAR 12
AUDIT\$OPERATION	CHAR 32
AUDIT\$DESIRED_ACCESS	CHAR 16
AUDIT\$SUB_STATUS	CHAR 32
AUDIT\$FINAL_STATUS	CHAR 32
AUDIT\$RDB_PRIV	CHAR 16
AUDIT\$VMS_PRIV	CHAR 16
AUDIT\$GRANT_IDENT	CHAR 192
AUDIT\$NEW_ACE	CHAR 192
AUDIT\$OLD_ACE	CHAR 192
AUDIT\$RMU_COMMAND	CHAR 512

¹Prior to Oracle Rdb V7.0, RDBVMS\$TSN data type and length was CHAR 12.

- Dates stored in ASCII text format can be converted to the VMS DATE data type format by the RMU Load command. See Example 7 in the Examples section, which demonstrates this conversion.
- To preserve the NULL indicator in a load or unload operation, specify the Null option when you use the Record_Definition qualifier. Using the Record_Definition qualifier without the Null option causes the RMU Load command to replace all NULL values with zeros. This can cause unexpected results with computed-by columns.
- When the RMU Load command is issued for a closed database, the command executes without other users being able to attach to the database.

1.28 RMU Load Command

- The RMU Load command recognizes character set information. When you load a table, the RMU Load command recognizes that the correct size of a column is based on its character set. For example, the RMU Load command recognizes that a column defined as CHAR (10) CHARACTER SET KANJI occupies 20 octets.
- By default, the RMU Load command changes any table or column names that you specify to uppercase. To preserve lowercase characters, use delimited identifiers; that is, enclose the names in quotation marks (" ").
- If your database uses a character set other than the DEC Multinational character set (MCS) for table and domain names, or if you edit a record definition file to use names from such a character set, the RMU Load command could fail and return the error shown in the following example:

```
$ RMU/UNLOAD/RECORD_DEFINITION=FILE=STRINGS MIA -
  "TAB_°;°çabcd°§ABCD°@°ª" -
  STRINGS.UNL
%RMU-I-DATRECUNL, 4 data records unloaded
$ RMU LOAD/RECORD_DEFINITION=FILE=STRINGS MIA -
  "TAB_°;°çabcd°§ABCD°@°ª" -
  STRINGS.UNL
  DEFINE FIELD DEC_MCS_CHAR DATATYPE IS TEXT SIZE IS 20.
  DEFINE FIELD KANJI_CHAR DATATYPE IS TEXT SIZE IS 10 CHARACTERS -
    CHARACTER SET IS KANJI.
  DEFINE FIELD HANZI_CHAR DATATYPE IS TEXT SIZE IS 10 CHARACTERS -
    CHARACTER SET IS HANZI.
  DEFINE FIELD HANYU_CHAR DATATYPE IS TEXT SIZE IS 10 CHARACTERS -
    CHARACTER SET IS HANYU.
  .
  .
  .
  DEFINE RECORD TAB_°;°çabcd°§ABCD°@°ª.
%RMU-F-RECDEFSYN, Syntax error in record definition file
  DEFINE RECORD TAB_''°;°çABCD°§ABCD°@°ª.
```

When this problem occurs, edit the record definition file and modify the names so that they can be represented with the MCS character set.

- Oracle RMU does not support the multischema naming convention and returns an error if you specify one. For example:

```
$ RMU/LOAD/FIELDS=(EMPLOYEE_ID, LAST_NAME) -
_$_ /RECORD_DEFINITION=(FILE=TEXT_NAMES, EXCEPTION_FILE=FILE.UNL) -
_$_ corporate_data ADMINISTRATION.PERSONNEL.EMPLOYEES EMP.UNL
%RDB-E-BAD_DPB_CONTENT, invalid database parameters in the database
parameter block (DPB)
%RMU-I-DATRECSTO, 0 data records stored
%RMU-I-DATRECREJ, 0 data records rejected.
```

1.28 RMU Load Command

When using a multischema database, you must specify the SQL stored name for the database object. For example, to find the stored name that corresponds to the ADMINISTRATION.PERSONNEL.EMPLOYEES table in the corporate_data database, issue an SQL SHOW TABLE command.

```
SQL> SHOW TABLE ADMINISTRATION.PERSONNEL.EMPLOYEES
Information for table ADMINISTRATION.PERSONNEL.EMPLOYEES
  Stored name is EMPLOYEES
  .
  .
  .
```

Then, to load the table, issue the following RMU Load command:

```
$ RMU/LOAD/FIELDS=(EMPLOYEE_ID, LAST_NAME) -
_$/RECORD_DEFINITION=(FILE=TEXT_NAMES,EXCEPTION_FILE=FILE.UNL) -
_$/CORPORATE_DATA EMPLOYEES MY_DATA.UNL
%RMU-I-DATRECSTO, 3 data records stored
%RMU-I-DATRECREJ, 0 data records rejected.
```

The Fields qualifier can be used with indirect file references. When you use an indirect file reference in the field list, the referenced file is written to SYS\$OUTPUT if the DCL SET VERIFY command has been used. See Section 1.3 for more information.

- The Transaction_Type=Batch_Update qualifier cannot be used with multiple executors (Executor_Count greater than 1).
- The RMU Load procedure supports the loading of tables that reference system domains.
- If you use a synonym to represent a table or a view, the RMU Load command translates the synonym to the base object and processes the data as though the base table or view had been named. This implies that the unload interchange files (.UNL) or record definition files (.RRD) that contain the table metadata will name the base table or view and not use the synonym name. If the metadata is used against a different database, you may need to use the Match_Name qualifier to override this name during the RMU load process.

1.28 RMU Load Command

Examples

Example 1

This command loads the data from the RMS file, names.unl, into the newly created RETIREES table of the mf_personnel database. The record structure of RETIREES is in the file names.rrd. The names.unl and names.rrd files were created by a previous RMU Unload command. The unload operation unloaded data from a view derived from a subset of columns in the EMPLOYEES table.

```
$ RMU/LOAD/RECORD_DEFINITION=FILE=NAMES.RRD -  
_ $ MF_PERSONNEL RETIREES NAMES.UNL
```

1.28 RMU Load Command

Example 2

This command restarts an aborted load operation that was loading the newly created RETIREES table of the mf_personnel database from the names.unl file. The columns being loaded are EMPLOYEE_ID, LAST_NAME, and FIRST_NAME. The original load operation had committed 25 records. Beginning with the 26th record, the restarted load operation commits the transaction at every record until it reaches the original point of failure.

```
$ RMU/LOAD/FIELDS=(EMPLOYEE_ID, LAST_NAME, FIRST_NAME) -
_ $ /COMMIT_EVERY=1/SKIP=25 MF_PERSONNEL RETIREES NAMES.UNL
```

Example 3

This example loads a new table, PENSIONS, into the mf_personnel database by using record definitions located in the data dictionary.

This example assumes that you have first defined a temporary view, TEMP_PENSIONS, combining appropriate columns of the EMPLOYEES and SALARY_HISTORY tables. You must also create a permanent table, PENSIONS, into which you will load the data.

Unload the TEMP_PENSIONS view by using the RMU Unload command with the Record_Definition=File=name qualifier to create both an .rrd file containing the column definitions and a data.unl file containing the data from the TEMP_PENSIONS view. Load the new record definitions from the pensions.rrd file into the data dictionary by using the @ command at the CDO prompt. Then you can load the data into the PENSIONS table of the mf_personnel database by using the RMU Load command.

```
$ RMU/UNLOAD/RECORD_DEFINITION=FILE=PENSIONS.RRD MF_PERSONNEL -
_ $ TEMP_PENSIONS DATA.UNL
$ DICTIONARY OPERATOR
Welcome to CDO V7.0
The CDD/Repository V7.0 User Interface
Type HELP for help
CDO> @PENSIONS.RRD
CDO> EXIT
$ RMU/LOAD/RECORD_DEFINITION=PATH=PENSIONS MF_PERSONNEL PENSIONS -
_ $ DATA.UNL
```

Example 4

The following command loads the audit records for the mf_personnel database from the security audit journal file into the AUDIT_TABLE table in the mf_personnel database. Note that if the AUDIT_TABLE table does not exist, the RMU Load command with the Audit qualifier creates it with the columns shown in Table 1–12.

1.28 RMU Load Command

```
$ RMU/LOAD/AUDIT MF_PERSONNEL AUDIT_TABLE -  
_ $ SYS$MANAGER:SECURITY.AUDIT$JOURNAL  
%RMU-I-DATRECREAD, 12858 data records read from input file.  
%RMU-I-DATRECSTO, 27 data records stored.
```

Example 5

The following command loads the audit records for the mf_personnel database from the security audit journal file into the AUDIT_TABLE table into the audit_db database. Note that the AUDIT_TABLE table is not created when the database is created. In this case, the RMU Load command with the Audit=Database_File qualifier creates it with the columns shown in Table 1-12.

```
$ RMU/LOAD/AUDIT=DATABASE_FILE=MF_PERSONNEL AUDIT_DB AUDIT_TABLE -  
_ $ SYS$MANAGER:SECURITY.AUDIT$JOURNAL
```

1.28 RMU Load Command

Example 6

This example loads a new table, COLLEGES, into the mf_personnel database by using record definitions located in the data dictionary. A commit operation occurs after every record is stored. The Log_Commits qualifier prints a message after each commit operation.

```
$ RMU/LOAD/RECORD_DEFINITION=FILE=COLLEGES.RRD /COMMIT_EVERY=1 -
_ $ /LOG_COMMIT MF_PERSONNEL COLLEGES RMU.UNL
%RMU-I-DATRECSTO, 1 data records stored
%RMU-I-DATRECSTO, 2 data records stored
%RMU-I-DATRECSTO, 3 data records stored
%RMU-I-DATRECSTO, 4 data records stored
%RMU-I-DATRECSTO, 4 data records stored
$
```

Example 7

The following example shows how a date stored in the .unl file as 16-character collatable text can be converted to VMS DATE format when loaded into the database by using the RMU Load command. (The form of the .unl date is *yyyymmddhhmmsscc*, whereas the form of the VMS DATE is *dd-mmm-yyyy:hh:mm:ss.cc*. In both cases, *y* is the year, *m* is the month, *d* is the day, *h* is the hour, *m* is the minute, *s* is the second, and *c* is hundredths of a second. However in the .unl format, the month is expressed as an integer, whereas in the VMS DATE format the month is expressed as a 3-character string.)

The example assumes that the default SYS\$LANGUAGE is ENGLISH.

```
SQL> --
SQL> -- Show the definition of the TEST table, in which the
SQL> -- COL1 column is the VMS DATE data type:
SQL> --
SQL> SHOW TABLE DATETEST;

Columns for table DATETEST:
Column Name          Data Type          Domain
-----
COL1                  DATE VMS
```

1.28 RMU Load Command

```
.
.
.
$ !
$ ! Show the .unl file that will be loaded into the TEST table:
$ !
$ TYPE TEST.UNL
$ !
1991060712351212
$ !
$ ! Note that the .rrd file shows a data type of TEXT of 16
$ ! characters. These 16 characters are the number of characters
$ ! specified for the date in the test.unl file:
$ !

$ TYPE TEST.RRD
DEFINE FIELD COL1 DATATYPE IS text size is 16.
DEFINE RECORD TEST.
    COL1 .
END TEST RECORD.
$ !
$ ! Load the data in test.unl into the DATETEST table:
$ !
$ RMU/LOAD/RMS=FILE=TEST.RRD TEST.RDB DATETEST TEST.UNL
%RMU-I-DATRECREAD, 1 data records read from input file.
%RMU-I-DATRECSTO, 1 data records stored.
$ !
$ SQL
SQL> ATTACH 'FILENAME TEST';
SQL> SELECT * FROM DATETEST;
    COL1
    7-JUN-1991 12:35:12.12
1 row selected
```

Example 8

The following example shows how a date stored in the .unl file as 22-character collatable text can be converted to `TIMESTAMP` format when loaded into the database by using the RMU Load command. The correct format for the .unl `TIMESTAMP` value is `yyyy-mm-dd:hh:mm:ss.cc`, where `y,m,d,h,m,s`, and `c` represent the same elements of the date and time format as described in Example 7.

This example also shows the use of an exception file to trap data that cannot be stored.

1.28 RMU Load Command

```
$ ! Create a column in the mf_personnel database with a
$ ! TIMESTAMP datatype:
$ SQL
SQL> ATTACH 'FILENAME MF_PERSONNEL.RDB';
SQL> CREATE TABLE NEWTABLE (COL1 TIMESTAMP);
SQL> SHOW TABLE (COLUMN) NEWTABLE;
Information for table NEWTABLE
Columns for table NEWTABLE:
Column Name                Data Type                Domain
-----
COL1                        TIMESTAMP(2)
SQL> COMMIT;
SQL> EXIT
$ !
$ ! Create a .unl file with the data you want to load. Note that
$ ! the second value is a valid TIMESTAMP specification, the first
$ ! value is not.
$ !
$ CREATE TEST.UNL
06-14-1991:12:14:14.14
1991-06-14:12:14:14.14
$ !
$ ! Create an .rrd file that defines the TIMESTAMP field
$ ! as a TEXT field:
$ !
$ CREATE TEST.RRD
DEFINE FIELD COL1 DATATYPE IS TEXT SIZE 22.
DEFINE RECORD NEWTABLE.
    COL1.
END NEWTABLE RECORD.
$ !
$ ! Attempt to load the data in the .unl file. Oracle RMU returns an
$ ! error on the first data record because the date was incorrectly
$ ! specified. The first record is written to the exception file,
$ ! BAD.DAT.
$ !
$ RMU/LOAD/RMS=(FILE=TEST.RRD,EXCEPT=BAD.DAT) MF_PERSONNEL.RDB -
_$ NEWTABLE TEST.UNL
%RMU-I-LOADERR, Error loading row 1.
%RDB-E-CONVERT_ERROR, invalid or unsupported data conversion
-COSI-F-IVTIME, invalid date or time
%RMU-I-DATRECREAD, 2 data records read from input file.
%RMU-I-DATRECSTO, 1 data records stored.
%RMU-I-DATRECREJ, 1 data records rejected.
```

1.28 RMU Load Command

```
$ !
$ ! Type BAD.DAT to view the incorrect data record
$ !
$ TYPE BAD.DAT
06-14-1991:12:14:14.14
$ !
$ ! Fetch the data record that stored successfully.
$ !

$ SQL
SQL> ATTACH 'FILENAME MF_PERSONNEL.RDB';
SQL> SELECT * FROM NEWTABLE;
  COL1
 1991-06-14:12:14:14.14
1 rows selected
```

Example 9

Using the RMU Load command, you can load a table in a database by placing the fields in a different order in the database than they were in the input file.

The jobs.unl file contains the following:

```
000001000000000190001Rdb Demonstrator DEMO
```

The jobs.rrd file contains the following:

```
DEFINE FIELD J_CODE DATATYPE IS TEXT SIZE IS 4.
DEFINE FIELD WAGE_CL DATATYPE IS TEXT SIZE IS 1.
DEFINE FIELD J_TITLE DATATYPE IS TEXT SIZE IS 20.
DEFINE FIELD MIN_SAL DATATYPE IS TEXT SIZE IS 10.
DEFINE FIELD MAX_SAL DATATYPE IS TEXT SIZE IS 10.
DEFINE RECORD JOBS.
  MIN_SAL.
  MAX_SAL.
  WAGE_CL.
  J_TITLE.
  J_CODE.
END JOBS RECORD.
```

The JOBS table has the following structure:

Columns for table JOBS:		
Column Name	Data Type	Domain
-----	-----	-----
JOB_CODE	CHAR(4)	JOB_CODE_DOM
WAGE_CLASS	CHAR(1)	WAGE_CLASS_DOM
JOB_TITLE	CHAR(20)	JOB_TITLE_DOM
MINIMUM_SALARY	INTEGER(2)	SALARY_DOM
MAXIMUM_SALARY	INTEGER(2)	SALARY_DOM

1.28 RMU Load Command

Notice that:

- The ordering of the columns is different for the JOBS table in the database and in the input RMS file.
- The names in the .rrd file are also different from the names in the database.
- The data types of the salary fields are different (Oracle Rdb will do the conversion).

To load the RMS file correctly, you must use the following command:

```
$ RMU/LOAD MF_PERSONNEL JOBS JOBS/RMS=FILE=JOBS -
_ $ /FIELDS=(MINIMUM_SALARY,MAXIMUM_SALARY,WAGE_CLASS,JOB_TITLE, -
_ $ JOB_CODE)
```

Notice that the Fields qualifier uses the names of the columns in the JOBS table (not the field names in the .rrd file), but in the order of the RMS file.

The names in the .rrd file are immaterial. The purpose of the Fields qualifier is to load the first field in the RMS file into the MINIMUM_SALARY column of the JOBS table, load the second field in the RMS file into the MAXIMUM_SALARY column of the JOBS table, and so forth.

The results:

```
SQL> SELECT * FROM JOBS WHERE JOB_CODE = 'DEMO';

JOB_CODE  WAGE_CLASS  JOB_TITLE           MINIMUM_SALARY  MAXIMUM_SALARY
-----  -
DEMO      1           Rdb Demonstrator   $10,000.00      $19,000.00
```

Example 10

The following example shows the sequence of steps used to sort a file into placement order by using the Place qualifier and the Place_Only option and then to load the file by using the Commit_Every qualifier:

```
$ RMU/LOAD/PLACE -
_ $ /RECORD_DEFINITION=(FILE=NAMES.RRD,PLACE_ONLY=PLACED_NAMES) -
_ $ MF_PERSONNEL EMPLOYEES UNLOADED_NAMES.UNL

$ RMU/LOAD/RECORD_DEFINITION=(FILE=NAMES.RRD) -
_ $ /COMMIT_EVERY=30 MF_PERSONNEL -
_ $ EMPLOYEES PLACED_NAMES.UNL
%RMU-I-DATRECREAD, 100 data records read from input file.
%RMU-I-DATRECSTO, 100 data records stored.
```

1.28 RMU Load Command

Example 11

The following example requests that statistics be displayed at a regular interval of every minute. It loads the data from the RMS file, names.unl, into the EMPLOYEES table of the mf_personnel database. The record structure of EMPLOYEES is in the file names.rrd. The names.rrd file was created by a previous RMU Unload command that unloaded data from a subset of columns in the EMPLOYEES table.

```
$ RMU/LOAD/STATISTICS=(INTERVAL=60) -
_$/RECORD_DEFINITION=(FILE=NAMES) -
_$/FIELDS=(EMPLOYEE_ID, LAST_NAME) -
_$/MF_PERSONNEL EMPLOYEES NAMES.UNL
```

Example 12

The following example uses the Exception_File option to the Record_Definition qualifier to tell Oracle RMU the name of the file to hold the exception records. Oracle RMU returns informational messages to alert you to any data records rejected.

```
$ RMU/LOAD/FIELDS=(EMPLOYEE_ID, LAST_NAME) -
_$/RECORD_DEFINITION=(FILE=TEXT_NAMES,EXCEPTION_FILE=FILE.UNL) -
_$/MF_PERSONNEL EMPLOYEES NAMES.UNL
%RMU-I-LOADERR, Error loading row 1.
%RDB-E-NO_DUP, index field value already exists; duplicates not
  allowed for EMPLOYEES_HASH
%RMU-I-LOADERR, Error loading row 17.
%RDB-E-NO_DUP, index field value already exists; duplicates not
  allowed for EMPLOYEES_HASH
%RMU-I-LOADERR, Error loading row 33.
%RDB-E-NO_DUP, index field value already exists; duplicates not
  allowed for EMPLOYEES_HASH
%RMU-I-LOADERR, Error loading row 155.
%RDB-E-NO_DUP, index field value already exists; duplicates not
  allowed for EMPLOYEES_HASH
%RMU-I-DATRECREAD, 200 data records read from input file.
%RMU-I-DATRECSTO, 196 data records stored.
%RMU-I-DATRECREJ, 4 data records rejected.
```

Example 13

The following is an example of the format in which you can provide input data to the RMU Load command when you use the Format=Delimited_Text option with the Record_Definition qualifier. This is followed by the RMU Load command you use to load this data.

1.28 RMU Load Command

```
"99997", "ABUSHAKRA", "CAROLINE", "S", "5 CIRCLE STREET", "BOX 506",  
"CHELMSFORD", "MA", "02184", "1960061400000000"#  
"99996", "BRADFORD", "LEO", "M", "4 PLACE STREET", "BOX 555",  
"NASHUA", "NH", "03060", "1949051800000000"#
```

```
$ RMU/LOAD/FIELDS=(EMPLOYEE_ID, LAST_NAME, FIRST_NAME, -  
_ $ MIDDLE_INITIAL, ADDRESS_DATA_1, ADDRESS_DATA_2, -  
_ $ CITY, STATE, POSTAL_CODE, BIRTHDAY) -  
_ $ /RECORD_DEFINITION=(FILE= NAMES.RRD, -  
_ $ FORMAT=DELIMITED_TEXT, -  
_ $ TERMINATOR="#" ) -  
_ $ MF_PERSONNEL EMPLOYEES NAMES.UNL  
%RMU-I-DATRECREAD, 2 data records read from input file.  
%RMU-I-DATRECSTO, 2 data records stored.
```

Example 14

The following is an example of the format in which you must provide input data to the RMU Load command when you specify the Format=Text option with the Record_Definition qualifier. This is followed by the RMU Load command you use to load this data.

```
09166Watts      Leora      F  
09190Margolis  David      M  
09187McDonald  Lois       F
```

```
$ RMU/LOAD/FIELDS=(EMPLOYEE_ID, LAST_NAME, FIRST_NAME, SEX) -  
_ $ /RECORD_DEFINITION=(FILE=TEXT_NAMES.RRD, FORMAT=TEXT) -  
_ $ MF_PERSONNEL EMPLOYEES NAMES.UNL  
%RMU-I-DATRECREAD, 3 data records read from input file.  
%RMU-I-DATRECSTO, 3 data records stored.
```

Example 15

The following example assumes you want to load a data file into the JOBS table that contains more fields than the table definition in the mf_personnel database. The example first attempts to do this by just excluding the extra field from the list associated with the Fields qualifier. However, this causes an error to be returned. The example then uses the FILLER keyword in the .rrd file to tell Oracle RMU not to attempt to load the additional field. The command executes successfully.

The table definition for the JOBS table is as follows:

1.28 RMU Load Command

Columns for table JOBS:

Column Name	Data Type	Domain
-----	-----	-----
JOB_CODE	CHAR(4)	JOB_CODE_DOM
Primary Key constraint	JOBS_PRIMARY_JOB_CODE	
WAGE_CLASS	CHAR(1)	WAGE_CLASS_DOM
JOB_TITLE	CHAR(20)	JOB_TITLE_DOM
MINIMUM_SALARY	INTEGER(2)	SALARY_DOM
MAXIMUM_SALARY	INTEGER(2)	SALARY_DOM

The .rrd file for the data you want to load appears as follows (note that there is no corresponding field to JOB_STATUS in the mf_personnel database definition for the JOBS table):

```
DEFINE FIELD JOB_CODE DATATYPE IS TEXT SIZE IS 4.
DEFINE FIELD WAGE_CLASS DATATYPE IS TEXT SIZE IS 1.
DEFINE FIELD JOB_TITLE DATATYPE IS TEXT SIZE IS 20.
DEFINE FIELD MINIMUM_SALARY DATATYPE IS TEXT SIZE IS 13.
DEFINE FIELD MAXIMUM_SALARY DATATYPE IS TEXT SIZE IS 13.
DEFINE FIELD JOB_STATUS DATATYPE IS TEXT SIZE IS 4.
DEFINE RECORD JOBS.
    JOB_CODE .
    WAGE_CLASS .
    JOB_TITLE .
    MINIMUM_SALARY .
    MAXIMUM_SALARY .
    JOB_STATUS .
END JOBS RECORD.
```

The data file you want to load, jobs.unl, appears as follows:

```
DBAD4Corp Db Administratr55000.00    95000.00    old
```

You attempt to load the file in the mf_personnel database by listing only the fields in the RMU Load command that have corresponding fields defined in the database:

```
$ RMU/LOAD MF_PERSONNEL/RMS=(FILE=JOBS.RRD, FORMAT=TEXT) -
_ $ /FIELDS=(JOB_CODE, WAGE_CLASS, JOB_TITLE, MINIMUM_SALARY, -
_ $ MAXIMUM_SALARY) JOBS JOBS.UNL
%RMU-F-FLDMUSMAT, Specified fields must match in number and datatype
with the unloaded data
%RMU-I-DATRECST0, 0 data records stored
```

The workaround for the problem of a mismatch between your data and .rrd file, and database definition for a table is to use the FILLER keyword in your .rrd file, as follows:

1.28 RMU Load Command

```
DEFINE FIELD JOB_CODE DATATYPE IS TEXT SIZE IS 4.
DEFINE FIELD WAGE_CLASS DATATYPE IS TEXT SIZE IS 1.
DEFINE FIELD JOB_TITLE DATATYPE IS TEXT SIZE IS 20.
DEFINE FIELD MINIMUM_SALARY DATATYPE IS TEXT SIZE IS 13.
DEFINE FIELD MAXIMUM_SALARY DATATYPE IS TEXT SIZE IS 13.
DEFINE FIELD JOB_STATUS DATATYPE IS TEXT SIZE IS 4 FILLER. <-----
DEFINE RECORD JOBS.
  JOB_CODE .
  WAGE_CLASS .
  JOB_TITLE .
  MINIMUM_SALARY .
  MAXIMUM_SALARY .
  JOB_STATUS .
END JOBS RECORD.
```

Now that the .rrd file has been modified, attempt to load the record again:

```
$ RMU/LOAD MF_PERSONNEL/RMS=(FILE=JOBS.RRD, FORMAT=TEXT) -
_$/FIELDS=(JOB_CODE, WAGE_CLASS, JOB_TITLE, MINIMUM_SALARY, -
_$/MAXIMUM_SALARY) JOBS JOBS.UNL
%RMU-I-DATRECSTO, 1 data records stored.
```

Example 16

The following example demonstrates the use of the Null="*" option of the Record_Definition qualifier to signal to Oracle RMU that any data that appears as an unquoted asterisk in the .unl file should have the corresponding column in the database be flagged as NULL.

The example shows the contents of the .unl file, followed by the RMU Load command used to load this .unl file, and then the output from an SQL statement to display the data loaded.

```
"98888", "ABUSHAKRA", "CAROLINE", *, "5 CIRCLE STREET", "BOX 506",
"CHELMSFORD", "MA", "02184", "1960061400000000"#
"98889", "BRADFORD", "LEO", *, "4 PLACE STREET", "BOX 555", "NASHUA", "NH",
"03060", "1949051800000000"#
```

```
$ RMU/LOAD/FIELDS=(EMPLOYEE_ID, LAST_NAME, FIRST_NAME, -
_$/MIDDLE_INITIAL, ADDRESS_DATA_1, ADDRESS_DATA_2, -
_$/CITY, STATE, POSTAL_CODE, BIRTHDAY) -
_$/RECORD_DEFINITION=(FILE= EMPLOYEES.RRD, -
_$/FORMAT=DELIMITED_TEXT, -
_$/TERMINATOR="#", -
_$/NULL="*" ) -
_$/MF_PERSONNEL EMPLOYEES EMPLOYEES.UNL
%RMU-I-DATRECREAD, 2 data records read from input file.
%RMU-I-DATRECSTO, 2 data records stored.
```

1.28 RMU Load Command

```
SQL> ATTACH 'FILENAME MF_PERSONNEL.RDB';
SQL> SELECT * FROM EMPLOYEES WHERE EMPLOYEE_ID > '98000'
cont> AND MIDDLE_INITIAL IS NULL;
EMPLOYEE_ID  LAST_NAME      FIRST_NAME  MIDDLE_INITIAL
ADDRESS_DATA_1  ADDRESS_DATA_2  CITY
STATE  POSTAL_CODE  SEX  BIRTHDAY  STATUS_CODE
98888      ABUSHAKRA      CAROLINE    NULL
5 CIRCLE STREET  BOX 506      CHELMSFORD
MA  02184      ?  14-Jun-1960  N
98889      BRADFORD      LEO         NULL
4 PLACE STREET  BOX 555      NASHUA
NH  03060      ?  18-May-1949  N

2 rows selected
```

Example 17

The following example demonstrates the use of the Null="" option of the Record_Definition qualifier to signal to Oracle RMU that any data that is an empty string in the .unl file (as represented by two commas with no space separating them) should have the corresponding column in the database be flagged as NULL.

The example shows the contents of the .unl file, followed by the RMU Load command used to load this .unl file, and then the output from an SQL statement to display the data loaded.

```
"90021", "ABUSHAKRA", "CAROLINE", "A", "5 CIRCLE STREET", ,
"CHELMSFORD", "MA", "02184", "1960061400000000"#
"90015", "BRADFORD", "LEO", "B", "4 PLACE STREET", , "NASHUA", "NH",
"03030", "1949051800000000"#
```

```
$ RMU/LOAD/FIELDS=(EMPLOYEE_ID, LAST_NAME, FIRST_NAME, -
_ $ MIDDLE_INITIAL, ADDRESS_DATA_1, ADDRESS_DATA_2, -
_ $ CITY, STATE, POSTAL_CODE, BIRTHDAY) -
_ $ /RECORD_DEFINITION=(FILE= EMPLOYEES.RRD, -
_ $ FORMAT=DELIMITED_TEXT, -
_ $ TERMINATOR="#", -
_ $ NULL="") -
_ $ MF_PERSONNEL EMPLOYEES EMPLOYEES.UNL
%RMU-I-DATRECREAD, 2 data records read from input file.
%RMU-I-DATRECSTO, 2 data records stored.
```

```
$ SQL
SQL> ATTACH 'FILENAME MF_PERSONNEL.RDB';
SQL> SELECT * FROM EMPLOYEES WHERE ADDRESS_DATA_2 IS NULL;
EMPLOYEE_ID  LAST_NAME      FIRST_NAME  MIDDLE_INITIAL
ADDRESS_DATA_1  ADDRESS_DATA_2  CITY
STATE  POSTAL_CODE  SEX  BIRTHDAY  STATUS_CODE
90021      ABUSHAKRA      CAROLINE    A
5 CIRCLE STREET  NULL      CHELMSFORD
MA  02184      ?  14-Jun-1960  N
```

1.28 RMU Load Command

```
90015      BRADFORD      LEO      B
  4 PLACE STREET      NULL      NASHUA
    NH      03030      ?      18-May-1949  N
2 rows selected
```

Example 18

The following example is the same as Example 17 except it shows the use of the default value for the Null option of the Record_Definition qualifier to signal to Oracle RMU that any data that is an empty string in the .unl file (as represented by two commas with no space separating them) should have the corresponding column in the database be flagged as NULL.

The example shows the contents of the .unl file, followed by the RMU Load command used to load this .unl file, and then the output from an SQL statement to display the data loaded.

```
"90022", "ABUSHAKRA", "CAROLINE", "A", "5 CIRCLE STREET", ,
"CHELMSFORD", "MA", "02184", "1960061400000000"#
"90014", "BRADFORD", "LEO", "B", "4 PLACE STREET", , "NASHUA", "NH",
"03030", "1949051800000000"#

$ RMU/LOAD/FIELDS=(EMPLOYEE_ID, LAST_NAME, FIRST_NAME, -
_ $ MIDDLE_INITIAL, ADDRESS_DATA_1, ADDRESS_DATA_2, -
_ $ CITY, STATE, POSTAL_CODE, BIRTHDAY) -
_ $ /RECORD_DEFINITION=(FILE= EMPLOYEES.RRD, -
_ $ FORMAT=DELIMITED_TEXT, -
_ $ TERMINATOR="#", -
_ $ NULL) -
_ $ MF_PERSONNEL EMPLOYEES EMPLOYEES.UNL
%RMU-I-DATRECREAD, 2 data records read from input file.
%RMU-I-DATRECSTO, 2 data records stored.

$ SQL
SQL> ATTACH 'FILENAME MF_PERSONNEL.RDB';
SQL> SELECT * FROM EMPLOYEES WHERE EMPLOYEE_ID = '90022' OR
cont> EMPLOYEE_ID = '90014' AND ADDRESS_DATA_2 IS NULL;
EMPLOYEE_ID  LAST_NAME      FIRST_NAME  MIDDLE_INITIAL
ADDRESS_DATA_1  ADDRESS_DATA_2  CITY
STATE  POSTAL_CODE  SEX  BIRTHDAY  STATUS_CODE
90014      BRADFORD      LEO      B
  4 PLACE STREET      NULL      NASHUA
    NH      03030      ?      18-May-1949  N

90022      ABUSHAKRA      CAROLINE  A
  5 CIRCLE STREET      NULL      CHELMSFORD
    MA      02184      ?      14-Jun-1960  N

2 rows selected
```

1.28 RMU Load Command

Example 19

The following example demonstrates the use of the Null option of the Record_ Definition qualifier to signal to Oracle RMU that any data that is an empty string in the .unl file (as represented by two commas with no space separating them) should have the corresponding column in the database be flagged as NULL. In addition, any column for which there is only data for the first column or columns has the remaining columns set to NULL.

The example shows the contents of the .unl file, followed by the RMU Load command used to load this .unl file, and then the output from an SQL statement to display the data loaded.

```
"90026","ABUSHAKRA","CAROLINE","A","5 CIRCLE STREET","BOX 783",
"CHELMSFORD","MA","02184","1960061400000000"
"90011","BRADFORD","LEO",,,, "NASHUA","NH","03030","1949051800000000"
"90010"
"90009",,,,,,,,,,"1966061600000000"
```

```
$ RMU/LOAD/FIELDS=(EMPLOYEE_ID, LAST_NAME, FIRST_NAME, -
_ $ MIDDLE_INITIAL, ADDRESS_DATA_1, ADDRESS_DATA_2, -
_ $ CITY, STATE, POSTAL_CODE, BIRTHDAY) -
_ $ /RECORD_DEFINITION=(FILE= EMPLOYEES.RRD, -
_ $ FORMAT=DELIMITED_TEXT, -
_ $ NULL) -
_ $ MF_PERSONNEL EMPLOYEES EMPLOYEES.UNL
%RMU-I-DATRECREAD, 5 data records read from input file.
%RMU-I-DATRECSTO, 5 data records stored.
```

```
$ SQL
```

```
SQL> ATTACH 'FILENAME MF_PERSONNEL.RDB';
```

```
SQL> SELECT * FROM EMPLOYEES WHERE EMPLOYEE_ID ='90026' OR
```

```
cont> EMPLOYEE_ID BETWEEN '90009' AND '90011';
```

EMPLOYEE_ID	LAST_NAME	FIRST_NAME	MIDDLE_INITIAL	ADDRESS_DATA_1	ADDRESS_DATA_2	CITY
STATE	POSTAL_CODE	SEX	BIRTHDAY	STATUS_CODE		
90009	NULL	NULL	NULL	NULL	NULL	NULL
NULL	NULL	?	16-Jun-1966	N		
90010	NULL	NULL	NULL	NULL	NULL	NULL
NULL	NULL	?	NULL	N		
90011	BRADFORD	LEO	NULL	NULL	NULL	NASHUA
NULL	NH	03030	?	18-May-1949	N	
90026	ABUSHAKRA	CAROLINE	A	5 CIRCLE STREET	BOX 783	CHELMSFORD
MA	NULL	?	14-Jun-1960	N		

```
4 rows selected
```

1.28 RMU Load Command

Example 20

The following example demonstrates a parallel load operation. In this example, three executors are specified because there are three storage areas in the JOB_HISTORY table of the mf_personnel database. The Defer_Index_Updates qualifier is used because there are no constraints or triggers defined on the JOB_HISTORY table, and it is known that no other database activity will occur when this command is executed.

In addition, a plan file is generated to capture the specification of this load operation. See the next example for a description of the plan file.

Note that the pid provided in the output from this command is the process ID.

```
$ RMU/LOAD/PARALLEL=(EXEC=3)/DEFER_INDEX_UPDATES mf_personnel.rdb -
_ $ /RECORD_DEFINITION=(FILE=JOB_HIST,FORMAT=DELIMITED_TEXT, -
_ $ EXCEPTION_FILE=DISK1:[ERRORS]JOB_HIST.EXC) -
_ $ /STATISTICS=(INTERVAL=30)/LIST_PLAN=JOB_HISTORY.PLAN -
_ $ JOB_HISTORY JOB_HIST.UNL
%RMU-I-EXECUTORMAP, Executor EXECUTOR_1 (pid: 2941941B) will load
storage area EMPIDS_LOW.
%RMU-I-EXECUTORMAP, Executor EXECUTOR_2 (pid: 2941F01D) will load
storage area EMPIDS_MID.
%RMU-I-EXECUTORMAP, Executor EXECUTOR_3 (pid: 2941C81F) will load
storage area EMPIDS_OVER.

-----
ELAPSED: 0 00:00:30.05 CPU: 0:00:01.64 BUFIO: 59 DIRIO: 219 FAULTS: 2670
```

1.28 RMU Load Command

```
1640 data records read from input file.
1330 records loaded before last commit.
220 records loaded in current transaction.
0 records rejected before last commit.
0 records rejected in current transaction.
26 early commits by executors.
3 executors: 0 Initializing; 0 Idle; 0 Terminated
              0 Sorting; 2 Storing; 1 Committing; 0 Executing
```

```
-----
.
.
.
```

```
-----
ELAPSED: 0 00:02:30.12 CPU: 0:00:02.94 BUFINO: 103 DIRIO: 227 FAULTS: 267
1
```

```
8070 data records read from input file.
7800 records loaded before last commit.
210 records loaded in current transaction.
0 records rejected before last commit.
0 records rejected in current transaction.
139 early commits by executors.
3 executors: 0 Initializing; 0 Idle; 0 Terminated
              0 Sorting; 1 Storing; 2 Committing; 0 Executing
```

```
-----
%RMU-I-EXECSTAT0, Statistics for EXECUTOR_1:
%RMU-I-EXECSTAT1, Elapsed time: 00:02:45.84 CPU time: 12.95
%RMU-I-EXECSTAT2, Storing time: 00:00:45.99 Rows stored: 2440
%RMU-I-EXECSTAT3, Commit time: 00:01:33.17 Direct I/O: 6623
%RMU-I-EXECSTAT4, Idle time: 00:00:22.34 Early commits: 47

%RMU-I-EXECSTAT0, Statistics for EXECUTOR_2:
%RMU-I-EXECSTAT1, Elapsed time: 00:02:48.42 CPU time: 18.10
%RMU-I-EXECSTAT2, Storing time: 00:01:24.98 Rows stored: 4319
%RMU-I-EXECSTAT3, Commit time: 00:01:18.13 Direct I/O: 9621
%RMU-I-EXECSTAT4, Idle time: 00:00:01.03 Early commits: 29

%RMU-I-EXECSTAT0, Statistics for EXECUTOR_3:
%RMU-I-EXECSTAT1, Elapsed time: 00:02:46.50 CPU time: 9.78
%RMU-I-EXECSTAT2, Storing time: 00:00:11.12 Rows stored: 2293
%RMU-I-EXECSTAT3, Commit time: 00:02:26.67 Direct I/O: 3101
%RMU-I-EXECSTAT4, Idle time: 00:00:04.14 Early commits: 77

%RMU-I-EXECSTAT5, Main process idle time: 00:02:41.06
%RMU-I-DATRECREAD, 9052 data records read from input file.
%RMU-I-DATRECSTO, 9052 data records stored.
%RMU-I-DATRECREJ, 0 data records rejected.
```

1.28 RMU Load Command

Example 21

The following command is the same as in the previous example, except the Noexecute qualifier is specified. Because this qualifier is specified, the load operation is not performed. However, the load plan file is created and verified.

```
$ RMU/LOAD/PARALLEL=(EXEC=3)/DEFER_INDEX_UPDATES/NOEXECUTE -  
_ $ mf_personnel.rdb -  
_ $ /RECORD_DEFINITION=(FILE=JOB_HIST,FORMAT=DELIMITED_TEXT, -  
_ $ EXCEPTION_FILE=DISK1:[ERRORS]JOB_HIST.EXC) -  
_ $ /STATISTICS=(INTERVAL=30)/LIST_PLAN=JOB_HISTORY.PLAN -  
_ $ JOB_HISTORY JOB_HIST.UNL
```

Example 22

The following display shows the contents of the plan file, JOB_HISTORY.PLAN, created in the preceding example. The following callouts are keyed to this display:

- 1 The Plan Parameters include all the parameters specified on the RMU Load command line and all possible command qualifiers.
- 2 Command qualifiers that are not specified on the command line are sometimes represented as comments in the plan file. This allows you to edit and adjust the plan file for future use.
- 3 Command qualifiers that are not specified on the command line and for which there are defaults are sometimes represented with their default value in the plan file.
- 4 Command qualifiers that are explicitly specified on the command line are represented in the plan file as specified.
- 5 Executor Parameters are listed for each executor involved in the load operation. Like the command qualifiers, both the values you specify on the command line and those that are allowed but were not specified are included in this list of parameters.
- 6 Note that the exception file extension is appended with the executor number. When you specify such files on the command line, Oracle RMU generates a separate file for each executor. If desired, you could edit this plan file to place each exception file on a different disk or directory.

```
! Plan created on 20-JUL-1995 by RMU/LOAD.
```

```
Plan Name = LOAD_PLAN  
Plan Type = LOAD
```

1.28 RMU Load Command

```
Plan Parameters:1
  Database Root File = MF_PERSONNEL.RDB;
  Table Name = JOB_HISTORY
  Input File = JOB_HIST.UNL

  ! Fields = <all> 2
  Transaction_Type = PROTECTED
  ! Buffers = <default>

  Row_Count = 50 3
  ! Skip = <none>
  NoLog_Commits
  NoCorresponding
  Defer_Index_Updates
  Constraints
  Parallel
  NoPlace
  Statistics = INTERVAL = 30 4
  NoTrigger_Relations
  Record_Definition_File = JOB_HIST
    Format = Delimited_Text
      Prefix = ""
      Suffix = ""
      NoNull
      Separator = ","
      End Of Line Terminator
End Plan Parameters

Executor Parameters: 5
  Executor Name = EXECUTOR_1
  ! Place_Only = <none>
  Exception_File = DISK1:[DATABASE]JOB_HIST.EXC_1; 6
  ! RUJ Directory = <default>
  Communication Buffers = 4
End Executor Parameters

Executor Parameters:
  Executor Name = EXECUTOR_2
  ! Place_Only = <none>
  Exception_File = DISK1:[DATABASE]JOB_HIST.EXC_2;
  ! RUJ Directory = <default>
  Communication Buffers = 4
End Executor Parameters

Executor Parameters:
  Executor Name = EXECUTOR_3
  ! Place_Only = <none>
  Exception_File = DISK1:[DATABASE]JOB_HIST.EXC_3;
  ! RUJ Directory = <default>
  Communication Buffers = 4
End Executor Parameters
```

1.28 RMU Load Command

Example 23

The following example demonstrates the structure of the record definition file (.rrd) for an RMU Load command for several different data types. The first part of the example displays the table definition, the second part shows the RMU Unload command you could use to get an appropriate .rrd file for these data types, and the last part shows the .rrd file definitions for these data types:

```
SQL> attach 'filename data_types.rdb';
SQL> show table many_types;
Information for table MANY_TYPES

Columns for table MANY_TYPES:
Column Name          Data Type          Domain
-----
F_ID                 TINYINT
F_CHAR_3             CHAR(3)
F_TINYINT            TINYINT
F_SMALLINT           SMALLINT
F_INTEGER            INTEGER
F_BIGINT             BIGINT
F_NTINYINT           TINYINT(1)
F_NSMALLINT          SMALLINT(2)
F_NINTEGER           INTEGER(7)
F_NBIGINT            BIGINT(5)
F_REAL               REAL
F_DOUBLE_PREC        DOUBLE PRECISION
F_DATE_VMS           DATE VMS
F_DATE_ANSI          DATE ANSI
F_VARCHAR            VARCHAR(20)
F_FLOAT              REAL
F_DATE               DATE VMS
F_TIME               TIME
F_TIMESTAMP          TIMESTAMP(2)
F_INTERVAL           INTERVAL
                    DAY (2)

$ RMU/UNLOAD DATA_TYPES.RDB/RECORD_DEF=(FILE=MANY_TYPES.RRD) -
_ $ MANY_TYPES MANY_TYPES.UNL
```

1.28 RMU Load Command

```
$ TYPE MANY_TYPES.RRD
DEFINE FIELD F_ID DATATYPE IS SIGNED BYTE.
DEFINE FIELD F_CHAR_3 DATATYPE IS TEXT SIZE IS 3.
DEFINE FIELD F_TINYINT DATATYPE IS SIGNED BYTE.
DEFINE FIELD F_SMALLINT DATATYPE IS SIGNED WORD.
DEFINE FIELD F_INTEGER DATATYPE IS SIGNED LONGWORD.
DEFINE FIELD F_BIGINT DATATYPE IS SIGNED QUADWORD.
DEFINE FIELD F_NTINYINT DATATYPE IS SIGNED BYTE SCALE -1.
DEFINE FIELD F_NSMAILINT DATATYPE IS SIGNED WORD SCALE -2.
DEFINE FIELD F_NINTEGER DATATYPE IS SIGNED LONGWORD SCALE -7.
DEFINE FIELD F_NBIGINT DATATYPE IS SIGNED QUADWORD SCALE -5.
DEFINE FIELD F_REAL DATATYPE IS F_FLOATING.
DEFINE FIELD F_DOUBLE_PREC DATATYPE IS G_FLOATING.
DEFINE FIELD F_DATE_VMS DATATYPE IS DATE.
DEFINE FIELD F_DATE_ANSI DATATYPE IS DATE ANSI.
DEFINE FIELD F_VARCHAR DATATYPE IS TEXT SIZE IS 20.
DEFINE FIELD F_FLOAT DATATYPE IS F_FLOATING.
DEFINE FIELD F_DATE DATATYPE IS DATE.
DEFINE FIELD F_TIME DATATYPE IS TIME.
DEFINE FIELD F_TIMESTAMP DATATYPE IS TIMESTAMP SCALE -2.
DEFINE FIELD F_INTERVAL DATATYPE IS INTERVAL DAY SIZE IS 2 DIGITS.
DEFINE RECORD MANY_TYPES.
    F_ID .
    F_CHAR_1 .
    . . .
END MANY_TYPES RECORD.
```

Example 24

The following example shows part of a script for loading a copy of the PERSONNEL database using the output from SQL EXPORT.

1.28 RMU Load Command

```
$! Export the database definition and the data
$ sql$ export database filename personnel into pers.rbr;
$
$! Create an empty database (use RMU Load to add data)
$ sql$ import database from pers.rbr filename copy_pers no data;
$
$! Now use load to add the same table
$ rmu/load copy_pers /match_name=employees employees pers.rbr
%RMU-I-DATRECREAD, 100 data records read from input file.
%RMU-I-DATRECSTO, 100 data records stored.
$
$ rmu/load copy_pers /match_name job_history pers.rbr
%RMU-I-DATRECREAD, 274 data records read from input file.
%RMU-I-DATRECSTO, 274 data records stored.
$
$ rmu/load copy_pers /match_name salary_history pers.rbr
%RMU-I-DATRECREAD, 729 data records read from input file.
%RMU-I-DATRECSTO, 729 data records stored.
$
.
.
.
$ rmu/load copy_pers /match_name work_status pers.rbr
%RMU-I-DATRECREAD, 3 data records read from input file.
%RMU-I-DATRECSTO, 3 data records stored.
```

1.29 RMU Load Plan Command

Executes a load plan file previously created with the RMU Load command (or created manually by the user).

Format

RMU/Load/Plan plan-file

<u>Command Qualifiers</u>	<u>Defaults</u>
/[No]Execute	Execute
/List_Plan=output-file	None

Description

A load plan file is created when you execute an RMU Load command with the List_Plan qualifier. See Section 1.28 for details on creating a plan file, the format of a plan file, and understanding the informational messages returned by a Parallel Load operation.

Command Parameters

plan-file-spec

The file specification for the load plan file. The default file extension is .plan.

Command Qualifiers

Execute

Noexecute

The Execute qualifier specifies that the plan file is to be executed. The Noexecute qualifier specifies that the plan file should not be executed, but rather that a validity check be performed on the contents of the plan file.

The validity check determines such things as whether the specified table is in the specified database, the .rrd file (if specified) matches the table, and so on. The validity check does not determine such things as whether your process and global page quotas are sufficient.

By default, data is loaded when the RMU Load Plan command is issued.

1.29 RMU Load Plan Command

List_Plan=output-file

Specifies that Oracle RMU should generate a new plan file and write it to the specified output file. This new plan file is identical to the plan file you specified on the command line (the “original” plan file) with the following exceptions:

- Any comments that appear in the original plan file will not appear in the new plan file.
- If the number of executors specified in the original plan file exceeds the number of storage areas that the table being loaded contains, the new plan file will reduce the number of executors to match the number of storage areas.

Usage Notes

- To use the RMU Load Plan command for a database, you must have the RMU\$LOAD privilege in the root file access control list (ACL) for the database or the OpenVMS SYSPRV or BYPASS privilege. Privileges for accessing the database tables involved are also required.
- When the load plan is executed, executors are created as detached processes if you have the OpenVMS DETACH privilege. If you do not have the OpenVMS DETACH privilege, executors are created as subprocesses of your process.

Examples

Example 1

The following example demonstrates the following:

1. The first Oracle RMU command creates a parallel load plan file. The RMU Load command is not executed because the point of issuing the command is to create the plan file, not to load data. Notice that the created load plan has only three executors, even though four were specified on the command line. This is because EMPLOYEEES has only three storage areas.
2. The load plan file generated by the first Oracle RMU command is displayed.
3. The load plan file is edited to change some parameters and to rename the executors with names that describe the storage area each executor is responsible for loading.
4. The edited version of the load plan file is executed.

1.29 RMU Load Plan Command

```
$ RMU/LOAD/PARALLEL=(EXECUTOR_COUNT=4, BUFFER_COUNT=4)/NOEXECUTE -
_$_ /RECORD_DEFINITION=(FILE=EMPLOYEES.RRD, FORMAT=DELIMITED) -
_$_ /LIST_PLAN=EMPLOYEES.PLAN MF_PERSONNEL.RDB EMPLOYEES EMPLOYEES.UNL
%RMU-W-TOOMANYEXECS, 4 executors were requested, but only 3 executors
will be used.
$ !
$ TYPE EMPLOYEES.PLAN
! Plan created on 20-JUL-1995 by RMU/LOAD.

Plan Name = LOAD_PLAN
Plan Type = LOAD

Plan Parameters:
  Database Root File = MF_PERSONNEL.RDB
  Table Name = EMPLOYEES
  Input File = EMPLOYEES.UNL

  ! Fields = <all>
  Transaction_Type = PROTECTED
  ! Buffers = <default>

  Row_Count = 50
  ! Skip = <none>
  NoLog_Commits
  NoCorresponding
  NoDefer_Index_Updates
  Constraints
  Parallel
  NoPlace
  ! Statistics = <none>
  NoTrigger_Relations
  Record_Definition_File = EMPLOYEES.RRD
    Format = Delimited_Text
      Prefix = ""
      Suffix = ""
      NoNull
      Separator = ","
      End Of Line Terminator
End Plan Parameters

Executor Parameters:
  Executor Name = EXECUTOR_1
  ! Place_Only = <none>
  ! Exception_File = <none>
  ! RUJ Directory = <default>
  Communication Buffers = 4
End Executor Parameters
```

1.29 RMU Load Plan Command

```
Executor Parameters:
  Executor Name = EXECUTOR_2
  ! Place_Only = <none>
  ! Exception_File = <none>
  ! RUJ Directory = <default>
  Communication Buffers = 4
End Executor Parameters
```

```
Executor Parameters:
  Executor Name = EXECUTOR_3
  ! Place_Only = <none>
  ! Exception_File = <none>
  ! RUJ Directory = <default>
  Communication Buffers = 4
End Executor Parameters
```

The following is an edited version of the plan file presented in the previous example. The file has been edited as follows:

- Comments have been added to indicate that the file has been edited.
- The Row_Count value has been changed from 50 to 60.
- Each executor name has been changed to reflect the storage area the executor is responsible for loading.

This makes it easier to determine the storage area from which a record was rejected if an error occurs during loading. In addition, it makes it easier to determine, when records are rejected, which executor was attempting to load it and which Rdb error corresponds to a particular executor.

- The directory and file name for each exception file has been changed and the comment character preceding "Exception_File" has been removed.
- Directories for the .ruj files have been added and the comment character preceding "RUJ Directory" has been removed.

```
! Plan created on 20-JUL-1995 by RMU/LOAD.
! Edited on 21-JUL-1995 by John Stuart
```

```
Plan Name = LOAD_PLAN
Plan Type = LOAD
```

```
Plan Parameters:
  Database Root File = MF_PERSONNEL.RDB
  Table Name = EMPLOYEES
  Input File = EMPLOYEES.UNL

  ! Fields = <all>
  Transaction_Type = PROTECTED
  ! Buffers = <default>
```

1.29 RMU Load Plan Command

```
Row_Count = 20
! Skip = <none>
NoLog_Commits
NoCorresponding
NoDefer_Index_Updates
Constraints
Parallel
NoPlace
! Statistics = <none>
NoTrigger_Relations
Record_Definition_File = EMPLOYEES.RRD
  Format = Delimited_Text
    Prefix = ""
    Suffix = ""
    NoNull
    Separator = ","
    End Of Line Terminator
End Plan Parameters

Executor Parameters:
  Executor Name = EMPIDS_LOW_EXEC
  ! Place_Only = <none>
  Exception_File = DISK1:[EXCEPTIONS]EMPIDS_LOW.EXC
  RUJ Directory = DISK1:[RUJ]EMPIDS_LOW.RUJ
  Communication Buffers = 4
End Executor Parameters

Executor Parameters:
  Executor Name = EMPIDS_MID_EXEC
  ! Place_Only = <none>
  Exception_File = DISK2:[EXCEPTIONS]EMPIDS_MID.EXC
  RUJ Directory = DISK2:[RUJ]EMPIDS_MID.RUJ
  Communication Buffers = 4
End Executor Parameters

Executor Parameters:
  Executor Name = EMPIDS_OVER_EXEC
  ! Place_Only = <none>
  Exception_File = DISK3:[EXCEPTIONS]EMPIDS_LOW.EXC
  RUJ Directory = DISK3:[RUJ]EMPIDS_LOW.RUJ
  Communication Buffers = 4
End Executor Parameters
```

1.29 RMU Load Plan Command

```
$ !
$ ! Execute the plan file.
$ ! Each executor is assigned the storage area or areas and
$ ! the pid (process ID) for each executor is displayed.
$ ! Notice that Oracle RMU notifies you if an error occurs when
$ ! an executor attempts to load a row, and then lists the Rdb error
$ ! message. Sometimes you receive two or more Oracle RMU
$ ! messages in a row and then the associated Oracle Rdb message. You
$ ! can match the Oracle RMU message to the Oracle Rdb message by
$ ! matching the executor name prefixes to the messages.
$ !
$ RMU/LOAD/PLAN EMPLOYEES.PLAN
%RMU-I-EXECUTORMAP, Executor EMPIDS_LOW_EXEC (pid: 3140A4CC) will
  load storage area EMPIDS_LOW.
%RMU-I-EXECUTORMAP, Executor EMPIDS_MID_EXEC (pid: 314086CD) will
  load storage area EMPIDS_MID.
%RMU-I-EXECUTORMAP, Executor EMPIDS_OVER_EXEC (pid: 314098CE) will
  load storage area EMPIDS_OVER.
EMPIDS_MID_EXEC: %RMU-I-LOADERR, Error loading row 4.
EMPIDS_LOW_EXEC: %RMU-I-LOADERR, Error loading row 1.
EMPIDS_MID_EXEC: %RDB-E-NO_DUP, index field value already exists;
  duplicates not allowed for EMPLOYEES_HASH
EMPIDS_LOW_EXEC: %RDB-E-NO_DUP, index field value already exists;
  duplicates not allowed for EMPLOYEES_HASH
%RMU-I-EXECSTAT0, Statistics for EMPIDS_LOW_EXEC:
%RMU-I-EXECSTAT1, Elapsed time: 00:00:51.69 CPU time: 4.51
%RMU-I-EXECSTAT2, Storing time: 00:00:32.33 Rows stored: 161
%RMU-I-EXECSTAT3, Commit time: 00:00:00.66 Direct I/O: 932
%RMU-I-EXECSTAT4, Idle time: 00:01:44.99 Early commits: 1
%RMU-I-EXECSTAT0, Statistics for EMPIDS_MID_EXEC:
%RMU-I-EXECSTAT1, Elapsed time: 00:01:06.47 CPU time: 4.32
%RMU-I-EXECSTAT2, Storing time: 00:00:38.80 Rows stored: 142
%RMU-I-EXECSTAT3, Commit time: 00:00:01.04 Direct I/O: 953
%RMU-I-EXECSTAT4, Idle time: 00:00:18.18 Early commits: 2
%RMU-I-EXECSTAT0, Statistics for EMPIDS_OVER_EXEC:
%RMU-I-EXECSTAT1, Elapsed time: 00:01:04.98 CPU time: 3.22
%RMU-I-EXECSTAT2, Storing time: 00:00:30.89 Rows stored: 100
%RMU-I-EXECSTAT3, Commit time: 00:00:00.90 Direct I/O: 510
%RMU-I-EXECSTAT4, Idle time: 00:00:26.65 Early commits: 1
%RMU-I-EXECSTAT5, Main process idle time: 00:00:58.11
%RMU-I-DATRECREAD, 495 data records read from input file.
%RMU-I-DATRECREAD, 403 data records stored.
%RMU-I-DATRECREJ, 92 data records rejected.
```

1.30 RMU Monitor Reopen_Log Command

1.30 RMU Monitor Reopen_Log Command

Closes the current Oracle Rdb monitor log file, compresses it, and opens another one without stopping the monitor.

Format

```
RMU/Monitor Reopen_Log
```

Description

The RMU Monitor Reopen_Log command closes the current Oracle Rdb monitor log file, compresses it, and opens another log file without stopping the monitor. The new log has the same name as, but a new version number of, the monitor log file you opened with the RMU Monitor Start command. Use the RMU Show Users command to determine the current name and location of the monitor log file before issuing the RMU Monitor Reopen_Log command. You should use the RMU Monitor Reopen_Log command if the monitor log file gets too large. For example, if you are running out of space on your disk or if database performance slows, you might want to open another log file.

If the disk that contains the Oracle Rdb monitor log file becomes full, you must acquire space on the disk. Once there is sufficient space on this disk, use the RMU Monitor Reopen_Log command and consider backing up (using the DCL COPY command or the OpenVMS Backup utility) the old monitor log file.

When the disk that contains the monitor log becomes full, Oracle Rdb stops writing to the log file, but the Oracle Rdb system does not stop operating. A message is sent to the cluster system operator when this occurs.

Usage Notes

- To use the RMU Monitor Reopen_Log command, either you must have the OpenVMS SETPRV privilege or the OpenVMS WORLD, CMKRNL, DETACH, PSWAPM, ALTPRI, SYSGBL, SYSNAM, SYSPRV, and BYPASS privileges.

1.30 RMU Monitor Reopen_Log Command

Examples

Example 1

The following example closes the existing monitor log file, compresses it, and creates a new one without stopping the Oracle Rdb monitor:

```
$ RMU/MONITOR REOPEN_LOG
```

See the *Oracle Rdb Guide to Database Maintenance* for more examples that show the RMU Monitor commands.

1.31 RMU Monitor Start Command

Activates the Oracle Rdb monitor process.

Format

RMU/Monitor Start

Command Qualifiers

/Output = file-name
/Priority = integer
/[No]Swap

Defaults

/Output=SYS\$SYSTEM:RDMMON.LOG
/Priority = 15
/Noswap

Description

The RMU Monitor Start command activates the Oracle Rdb monitor process (RDMS_MONITOR nn , where nn represents the version Oracle Rdb), sets the priority of this process, and specifies a device, directory and file name in which to create the monitor log file. If the monitor process is active already, you receive the following error message:

```
%RMU-F-MONMBXOPN, monitor is already running
```

An Oracle Rdb monitor process must be running on a node for users logged in to that node to use any Oracle Rdb database. In a VMScluster environment, a monitor process must be running on each node in the cluster from which databases are accessed.

The Oracle Rdb monitor process controls all database access and initiates the automatic database recovery procedure following a system failure or other abnormal termination of a database user process.

See the *Oracle Rdb Installation and Configuration Guide* for information on support for multiple versions of Oracle Rdb.

Command Qualifiers

Output=file-name

Specifies the device, directory, and file name that receives the monitor log. You can use this qualifier to redirect the placement of your monitor log file. The default device and directory is the SYS\$SYSTEM directory. The default log file name is RDMMON.LOG. The RMU Monitor Start command causes a new version of the log file to be created for each database session.

1.31 RMU Monitor Start Command

Priority=integer

Specifies the base priority of the monitor process. This priority should always be higher than the highest database user process priority.

By default, the monitor runs at the highest interactive priority possible, 15. You should not normally have to lower the monitor process priority. If you change this to a lower priority, an attach operation can cause a deadlock. Deadlock occurs when multiple processes with higher priority than the monitor attempt to attach at the same time. In this case, the monitor must contend for CPU time with multiple higher-priority processes and is perpetually locked out. As a result, no one can use the database.

Swap

Noswap

Enables or disables swapping of the monitor process. The default is Noswap. The Swap qualifier is not recommended for time-critical applications, because no one can use the database while the monitor process is being swapped.

Usage Notes

- To use the RMU Monitor Start command, you must have either the OpenVMS SETPRV privilege or the OpenVMS WORLD, CMKRNL, DETACH, PSWAPM, ALTPRI, PRMMBX, SYSGBL, SYSNAM, SYSPRV, and BYPASS privileges.
- If the monitor has not been started on the system previously, use the RMONSTART.COM command file (which, by default, is located in the SYS\$STARTUP directory) instead of the RMU Monitor Start command.
- Start the monitor from the SYSTEM account, which has the SETPRV privilege. The process starting the monitor attempts to give RDMS_MONITOR all privileges. In particular, the privileges required are ALTPRI, CMKRNL, DETACH, PSWAPM, PRMMBX, SETPRV, SYSGBL, SYSNAM, and WORLD.
- The monitor process inherits some quotas, such as MAXDETACH, and the user name of the user who starts it. This can result in severe restrictions on user access. For example, if the user who starts the monitor has a MAXDETACH quota of two, then the monitor can only start two recovery processes at one time. However, the system defines most of the quotas needed by the monitor.

1.31 RMU Monitor Start Command

- If the LNM\$PERMANENT_MAILBOX table is not defined in the LNM\$SYSTEM_TABLE logical name table, either of the following might occur:

- The RMU Start Monitor command hangs
- You receive the error, “monitor is not running”, when you know it is.

By default, the LNM\$PERMANENT_MAILBOX table is defined in the LNM\$SYSTEM_TABLE logical name table. However, sometimes a user or third-party application redefines the LNM\$PERMANENT_MAILBOX table in another logical name table (such as the LNM\$GROUP table). To recover from this situation, follow these steps:

1. Define the LNM\$PERMANENT_MAILBOX table in the LNM\$SYSTEM_TABLE:

```
$ DEFINE/TABLE=LNMP$PROCESS_DIRECTORY LNM$PERMANENT_MAILBOX -
_$ LNM$SYSTEM
```

2. Start the database monitor:

```
RMU/MONITOR START
```

3. Start the application

Or, change the application that redefines the LNM\$PERMANENT_MAILBOX table so that LNM\$PERMANENT_MAILBOX is defined as a search list that includes the LNM\$SYSTEM_TABLE table, as shown in the following example:

```
$ DEFINE/TABLE=LNMP$PROCESS_DIRECTORY LNM$PERMANENT_MAILBOX -
_$ LNM$GROUP, LNM$SYSTEM
```

- Use the RMU Show System command to determine the location of the monitor log file if it is not in the default location. The monitor log file may not be in the default location if someone has issued the RMU Monitor Start command and specified a location different from the default with the Output qualifier.

CAUTION

The monitor process should be started only by a user whose account has adequate quotas. Ideally, the monitor process should be started from the SYSTEM account.

1.31 RMU Monitor Start Command

- To view the contents of monitor log file online (even when disk-based logging is disabled because of disk space problems), use the Performance Monitor and select the Monitor Log screen from the Per-Process menu. See the *Oracle Rdb7 Guide to Database Performance and Tuning* or the Performance Monitor Help for information about using the Performance Monitor.

Examples

Example 1

The following command activates the Oracle Rdb monitor process:

```
$ RMU/MONITOR START
```

See the *Oracle Rdb Guide to Database Maintenance* for more examples that show the RMU Monitor commands.

1.32 RMU Monitor Stop Command

Stops the Oracle Rdb monitor process.

Format

RMU/Monitor Stop

Command Qualifiers

/[No]Abort[={Forcex | Delprc}]
/[No]Wait

Defaults

/NOABORT
/NOWAIT

Description

The RMU Monitor Stop command stops the Oracle Rdb monitor process (RDMS_MONITOR nn , where nn represents the version Oracle Rdb) normally, either with a shutdown and rollback of the databases or an immediate abort. You can use the RMU Monitor Stop command to shut down all database activity on your node, optionally aborting user processes by forcing an image exit or deleting their processes.

The RMU Monitor Stop command closes the monitor log file also.

An Oracle Rdb monitor process must be running on a node for users logged in to that node to use any Oracle Rdb database. In a VMScluster environment, a monitor process must be running on each node in the cluster from which databases is accessed.

The Oracle Rdb monitor process controls all database access and initiates the automatic database recovery procedure following a system failure or other abnormal termination of a database user process. The monitor log file automatically tracks all access to the database.

Command Qualifiers

Abort=Delprc

Abort=Forcex

Noabort

The Abort=Forcex qualifier stops the monitor immediately without allowing current Oracle Rdb users to complete active transactions or detach from their databases. However, the user processes are not deleted. Active transactions are rolled back. If a process using a database is waiting for a subprocess to complete, the transaction is not rolled back until the subprocess completes.

1.32 RMU Monitor Stop Command

Using the Abort qualifier with no option is equivalent to specifying the Abort=Forcex qualifier.

The Abort=Delprc qualifier stops the monitor immediately without allowing current Oracle Rdb users to complete active transactions or detach from their databases. Each user process that was attached to an Oracle Rdb database is deleted immediately.

The Noabort qualifier allows current user processes to continue and complete before stopping. New users on the node are not allowed to attach to any database, but existing database users can complete their sessions normally. Once existing database user processes terminate, the database monitor shuts down.

The Noabort qualifier is the default.

Wait

Nowait

Specifies whether the Oracle RMU operation completes when the monitor acknowledges the stop request (Nowait), or whether RMU waits until the monitor finishes shutting down (Wait).

The default is Nowait.

Usage Notes

- To use the RMU Monitor Stop command, you must have either the OpenVMS SETPRV privilege or the OpenVMS WORLD, CMKRNL, DETACH, PSWAPM, PRMMBX, ALTPRI, SYSGBL, SYSNAM, SYSPRV, and BYPASS privileges.

Note

If Oracle Trace is installed on your system, you stall the Oracle Rdb monitor process with the RMU Monitor Stop command unless you do one of the following:

- Shut down Oracle Trace, then shut down the Oracle Rdb monitor (in that order).
 - Use the RMU Monitor Stop command with the Abort=Delprc qualifier to shut down Oracle Rdb and force the monitor out of the Oracle Trace database.
-

1.32 RMU Monitor Stop Command

Examples

Example 1

The following command causes the Oracle Rdb monitor process to shut down after existing database users end their access to the database. New users on this node are unable to attach to any Oracle Rdb database.

```
$ RMU/MONITOR STOP
```

Example 2

The following command causes the Oracle Rdb monitor to stop immediately without allowing current Oracle Rdb users to complete active transactions (they are rolled back) or detach (DISCONNECT) from their databases. However, the user processes are not deleted. Because the monitor is shut down, all Oracle Rdb activity on this node is terminated.

```
$ RMU/MONITOR STOP /ABORT=FORCEX
```

Example 3

The following command causes the Oracle Rdb monitor to stop immediately without allowing current Oracle Rdb users to complete active transactions (they are not rolled back) or detach (DISCONNECT) from their databases. Each user process that was attached to a Oracle Rdb database on this node is deleted immediately.

```
$ RMU/MONITOR STOP /ABORT=DELPRC
```

1.33 RMU Move_Area Command

1.33 RMU Move_Area Command

Permits you to move one or more storage areas to different disks. You can also choose to move the database root file to a different disk.

Format

RMU/Move_Area root-file-spec storage-area-list

Command Qualifiers

`/[No]After_Journal[=file-spec]`
`/[No]Aij_Options[=journal-opts-file]`
`/All_Areas`
`/[No]Area`
`/[No]Cdd_Integrate`
`/[No]Checksum_Verification`
`/Directory=directory-spec`
`/[No]Log`
`/Nodes_Max=n`
`/[No]Online`
`/Option=file-spec`
`/Page_Buffers=n`
`/Path=cdd-path`
`/[No]Quiet_Point`
`/Root=file-spec`
`/Users_Max=n`

Defaults

See description
See description
See description
See description
Nocdd_Integrate
/Checksum_Verification
None
Current DCL verify value
Keep current value
Noonline
None
n=3
Existing value
/Quiet_Point
None
Keep current value

File or Area Qualifiers

`/Blocks_Per_Page=n`
`/Extension={Disable | Enable }`
`/File=file-spec`
`/Read_Only`
`/Read_Write`
`/Snapshots=(Allocation=n,File=file-spec)`
`/[No]Spams`
`/Thresholds=(n,n,n)`

Defaults

None
Current value
None
Current value
Current value
None
Leave attribute unchanged
None

1.33 RMU Move_Area Command

Description

The RMU Move_Area command lets you modify certain area parameters when the move operation is performed. All the files are processed simultaneously during the move operation. The performance of the RMU Move_Area command is similar to that of the RMU Backup command, and it eliminates the need for intermediate storage media.

Note that when a snapshot file is moved, Oracle RMU does not actually move the snapshot file; instead, Oracle RMU re-creates and initializes the snapshot file in the specified location. See the description of the Snapshot qualifier for more information about using this qualifier, including information on its proper usage.

Note

You must perform a full and complete Oracle RMU backup operation immediately after the Oracle RMU move area operation completes to ensure that the database can be properly restored after a database failure or corruption.

Command Parameters

root-file-spec

The name of the database root file for the database whose storage areas you want to move.

storage-area-list

The name of one or more storage areas that you want to move.

Command Qualifiers

After_Journal[=file-spec]

Noafter_Journal

Note

This qualifier is maintained for compatibility with versions of Oracle Rdb prior to Version 6.0. You might find it more useful to specify the Aij_Options qualifier, unless you are only interested in creating extensible after-image journal (.aj) files.

1.33 RMU Move_Area Command

Specifies how Oracle RMU is to handle after-image journaling and .aij file creation, using the following rules:

- If you specify the `After_Journal` qualifier and provide a file specification, Oracle RMU enables after-image journaling and creates a new extensible after-image journal (.aij) file for the database.
- If you specify the `After_Journal` qualifier but do not provide a file specification, Oracle RMU enables after-image journaling and creates a new extensible .aij file for the database with the same name as, but a different version number from, the .aij file for the database root file being moved.
- If you specify the `Noafter_Journal` qualifier, Oracle RMU disables after-image journaling and does not create a new .aij file.
- If you do not specify an `After_Journal`, `Noafter_Journal`, `Aij_Options`, or `Noaij_Options` qualifier, Oracle RMU retains the original journal setting (enabled or disabled) and the original .aij file state.

You can only specify one, or none, of the following after-image journal qualifiers in a single RMU `Move_Area` command: `After_Journal`, `Noafter_Journal`, `Aij_Options`, or `Noaij_Options`.

You cannot use the `After_Journal` qualifier to create fixed-size .aij files; use the `Aij_Options` qualifier.

You can facilitate recovery by creating a new .aij file because a single .aij file cannot be applied across a move area operation that changes an area page size. A single .aij file cannot be applied across a move operation because the move operation is never recorded in the .aij file (and therefore the increase in page size is also not journaled). Therefore, when you attempt to recover the database, the original page size is used for recovery purposes. So, if the .aij file contains database insert transactions, these updates might have more free space associated with them than is available on the original page size. This results in an inability to recover the insert transaction, which in turn results in a bugcheck and a corrupted database.

This qualifier is valid only when no users are attached to the database and only when the root file is moved.

Aij_Options[=journal-opts-file]

Noaij_Options

Specifies how Oracle RMU is to handle after-image journaling and .aij file creation, using the following rules:

- If you specify the `Aij_Options` qualifier and provide a journal-opts-file, Oracle RMU enables journaling and creates the .aij file or files you specify

1.33 RMU Move_Area Command

for the database. If only one .aij file exists for the database, it will be an extensible .aij file. If two or more .aij files are created for the database, they will be fixed-size .aij files (as long as at least two .aij files are always available).

- If you specify the Aij_Options qualifier but do not provide a journal-opts-file, Oracle RMU disables journaling and does not create any new .aij files.
- If you specify the Noaij_Options qualifier, Oracle RMU retains the original journal setting (enabled or disabled) and retains the original .aij file.
- If you do not specify an After_Journal, Noafter_Journal, Aij_Options, or Noaij_Options qualifier, Oracle RMU retains the original journal setting (enabled or disabled) and the original .aij file state.

See Section 1.61.1 for information on the format of a journal-opts-file.

Note that you cannot use the RMU Move_Area command with the Aij_Options qualifier to alter the journal configuration. However, you can use it to define a new after-image journal configuration. When you use it to define a new after-image journal configuration, it does not delete the journals in the original configuration. Those can still be used for recovery. If you need to alter the after-image journal configuration, you should use the RMU Set After_Journal command.

The Aij_Options qualifier is valid only when no users are attached to the database and only when the root file is moved.

All_Areas

Specifies that all database storage areas are to be moved. If you specify the All_Areas qualifier, you do not need to specify a storage-area-list.

By default, only areas specified in the storage-area-list are moved.

Area

Noarea

Note

Due to the confusing semantics of the Area and Noarea qualifiers, the Area and Noarea qualifiers are deprecated. Oracle Corporation recommends that you use one of the following methods to specify areas to be moved:

- To move all the storage areas in the database use the All_Areas qualifier and do not specify a storage-area-list parameter

1.33 RMU Move_Area Command

- To move only selected areas in the database, specify the storage-area-list parameter or use the Options qualifier and specify an options file.
 - To move only the database root file for a multfile database, or to move an entire single-file database, specify the root qualifier and do not specify a storage-area-list parameter.
-

Controls whether specific storage areas are moved. If you specify the Area qualifier, only the storage areas specified in the option file or the storage-area-list are moved. If you specify Noarea, all the storage areas in the database are moved.

The default is the Area qualifier.

Cdd_Integrate

Nocdd_Integrate

Integrates the metadata from the root (.rdb) file of the moved database into the data dictionary (assuming the data dictionary is installed on your system).

If you specify the Nocdd_Integrate qualifier, no integration occurs during the move operation.

You can use the Nocdd_Integrate qualifier even if the DICTONARY IS REQUIRED clause was used when the database being moved was defined.

The Cdd_Integrate qualifier integrates definitions *in one direction only*—from the database file to the dictionary. The Cdd_Integrate qualifier does *not* integrate definitions from the dictionary to the database file.

The Nocdd_Integrate qualifier is the default.

Checksum_Verification

Nochecksum_Verification

Requests that the page checksum be verified for each page moved. The default is to perform this verification.

The Checksum_Verification qualifier uses CPU resources but can provide an extra measure of confidence in the quality of the data being moved.

Use of the Checksum_Verification qualifier offers an additional level of data security when the database employs disk striping or RAID (redundant arrays of inexpensive disks) technology. These technologies fragment data over several disk drives, and use of the Checksum_Verification qualifier permits Oracle RMU to detect the possibility that the data it is reading from these

1.33 RMU Move_Area Command

disks has been only partially updated. If you use either of these technologies, you should use the `Checksum_Verification` qualifier.

Oracle Corporation recommends that you use the `Checksum_Verification` qualifier with all move operations where integrity of the data is essential.

Directory=directory-spec

Specifies the destination directory for the moved database files. Note that if you specify a file name or file extension, all moved files are given that file name or file extension. There is no default directory specification for this qualifier.

See the Usage Notes for information on how this qualifier interacts with the `Root`, `File`, and `Snapshot` qualifiers and for warnings regarding moving database files into a directory owned by a resource identifier.

If you do not specify this qualifier, Oracle RMU attempts to move all the database files (unless they are qualified with the `Root`, `File`, or `Snapshot` qualifier) to their current location.

Log

Nolog

Specifies whether the processing of the command is reported to `SYS$OUTPUT`. Specify the `Log` qualifier to request log output and the `Nolog` qualifier to prevent it. If you specify neither, the default is the current setting of the `DCL verify` switch. (The `DCL SET VERIFY` command controls the `DCL verify` switch.)

Nodes_Max=n

Specifies a new value for the database maximum node count parameter. The default is to leave the value unchanged.

Use the `Nodes_Max` qualifier only if you move the database root file.

Online

Noonline

Allows the specified storage areas to be moved without taking the database off line. This qualifier can be used only when you specify the `storage-area-list` parameter, or when you specify the `Options=file-spec` qualifier. The default is `Noonline`. You cannot move a database root file when the database is on line. The `Root` qualifier cannot be specified with the `Online` qualifier in an `RMU Move_Area` command. In addition, an online move operation cannot be performed if `TRANSFER VIA MEMORY`, also referred to as optimized page transfer, is enabled. (See the description of the `SQL ALTER DATABASE` statement in the *Oracle Rdb SQL Reference Manual* for information on optimized page transfer.)

1.33 RMU Move_Area Command

Option=file-spec

Specifies an options file containing storage area names, followed by the storage area qualifiers that you want applied to that storage area. Do *not* separate the storage area names with commas. Instead, put each storage area name on a separate line in the file. The storage area qualifiers that you can include in the options file are:

- Blocks_Per_Page
- File
- Snapshot
- Thresholds

If you specify the Snapshot qualifier, you must also move the corresponding data files at the same time. To move a snapshot file independently of its corresponding data file, use the RMU Repair command with the Initialize=Snapshots=Confirm qualifier.

You can use the DCL line continuation character, a hyphen (-), or the comment character (!) in the options file.

There is no default for this qualifier. Example 3 in the Examples section shows the use of an options file.

If the Option qualifier is specified, the storage-area-list parameter is ignored.

Page_Buffers=n

Specifies the number of buffers to be allocated for each file to be moved. The number of buffers used is twice the number specified; half are used for reading the file and half for writing the moved files. Values specified with the Page_Buffers qualifier can range from 1 to 5. The default value is 3. Larger values might improve performance, but they increase memory usage.

Path=cdd-path

Specifies a data dictionary path into which the definitions of the moved database will be integrated. If you do not specify the Path qualifier, Oracle RMU uses the CDD\$DEFAULT logical name value of the user who enters the RMU Move_Area command.

If you specify a relative path name, Oracle Rdb appends the *relative* path name you enter to the CDD\$DEFAULT value. If the cdd-path parameter contains nonalphanumeric characters, you must enclose it within quotation marks (" ").

Oracle Rdb ignores the Path qualifier if you use the Nocdd_Integrate qualifier or if the data dictionary is not installed on your system.

1.33 RMU Move_Area Command

Quiet_Point

Noquiet_Point

Allows you to specify that a database move operation is to occur either immediately or when a quiet point for database activity occurs. A **quiet point** is defined as a point where no active update transactions are in progress in the database.

When you specify the Noquiet_Point qualifier, Oracle RMU proceeds with the move operation as soon as the RMU Move_Area command is issued, regardless of any update transaction activity in progress in the database. Because Oracle RMU must acquire exclusive locks on the physical and logical areas for the areas being moved, the move operation fails if there are any active transactions with exclusive locks on storage areas that are being moved. However, once Oracle RMU has successfully acquired all the needed concurrent-read storage area locks, it should not encounter any further lock conflicts. If a transaction is started that causes Oracle Rdb to request exclusive locks on the areas that are in the process of being moved, that transaction either waits or gets a lock conflict error, but the move area operation continues unaffected.

If you intend to use the Noquiet_Point qualifier with a move procedure that previously specified the Quiet_Point qualifier (or did not specify either the Quiet_Point or the Noquiet_Point qualifier), you should examine any applications that execute concurrently with the move operation. You might need to modify your applications or your move procedure to handle the lock conflicts that can occur when you specify the Noquiet_Point qualifier.

When you specify the Quiet_Point qualifier, the move operation begins when a quiet point is reached.

The default is Quiet_Point.

Root=file-spec

Requests that the database root file be moved to the specified location. If not specified, the database root file is not moved.

You must specify the Root qualifier when you use the RMU Move_Area command on a single-file database. If you omit the Root qualifier, you receive an error message. When you specify the Root qualifier, specify the location where you want the root file moved. For example:

```
$ RMU/MOVE_AREA/ROOT=DISK1:[DATABASE.TEST] MF_PERSONNEL
```

See the Usage Notes for information on how this qualifier interacts with the Directory, File, and Snapshot qualifiers.

Users_Max=n

Specifies a new value for the database maximum user count parameter.

1.33 RMU Move_Area Command

The default is to leave the value unchanged.

Use the Users_Max qualifier only if you move the database root file.

File or Area Qualifiers

Blocks_Per_Page=n

Specifies a new page size for the storage area to which it is applied. You cannot decrease the page size of a storage area, and you cannot change the size for a storage area with a uniform page format.

If you attempt to change the page size during an online Move_Area operation, you might receive a PAGESIZETOOBIG error message. Changing the page size sometimes requires that Oracle Rdb change the buffer size for the database also (because buffers must be large enough to hold at least one page from each area). However, the buffer size cannot change if other users are accessing the database.

You might want to increase the page size in storage areas containing hash indexes that are close to full. By increasing the page size in such a situation, you prevent the storage area from extending.

The Blocks_Per_Page qualifier is a positional qualifier.

Extension=Disable

Extension=Enable

Allows you to change the automatic file extension attribute when you move a storage area.

Use the Extension=Disable qualifier to disable automatic file extensions for one or more storage areas.

Use the Extension=Enable qualifier to enable automatic file extensions for one or more storage areas.

If you do not specify the Extension=Disable or the Extension=Enable qualifier, the storage areas is moved with the automatic file extension attributes that are currently in effect.

The Extension qualifier is a positional qualifier.

File=file-spec

Requests that the storage area to which this qualifier is applied be moved to the specified location.

The File qualifier is a positional qualifier. This qualifier is not valid for single-file databases.

1.33 RMU Move_Area Command

See the Usage Notes for information on how this qualifier interacts with the Root, Snapshot, and Directory qualifiers.

Read_Only

Use the Read_Only qualifier to change a read/write storage area or a write-once storage area to a read-only storage area.

If you do not specify the Read_Only or the Read_Write qualifier, the storage areas are moved with the read/write attributes that are currently in effect for the database.

This is a positional qualifier.

Read_Write

Use the Read_Write qualifier to change a read-only storage area or a write-once storage area to a read/write storage area.

If you do not specify the Read_Only or the Read_Write qualifier, the storage areas are moved with the read/write attributes that are currently in effect for the database.

This is a positional qualifier.

Snapshots=(Allocation=n, File=file-spec)

Allows you to specify a new snapshot file allocation size, a new snapshot file location, or both, for the storage area to which the qualifier is applied.

Use the Allocation=*n* option to specify the snapshot file allocation size in *n* pages; use the File=*file-spec* option to specify a new file location for the snapshot file associated with the area being moved.

Note that when you specify a new file location for the snapshot file, the snapshot file is not actually moved; instead, Oracle RMU creates and initializes a new snapshot file in the specified directory. However, if a snapshot file is accidentally deleted or becomes corrupt, using this qualifier is not the recommended or supported method for re-creating the snapshot file. Use the RMU Repair command instead. See the Section 1.40 for information on using the RMU Repair command to re-create and initialize a deleted or corrupted snapshot file.

If the keyword Allocation is omitted, the *original* allocation is used, not the storage area's current allocation size.

You cannot specify a snapshot file name for a single-file database. When you create a snapshot file, Oracle Rdb does not store the file specification of the snapshot file. Instead, it uses the file specification of the root file (.rdb) to determine the file specification of the snapshot file.

1.33 RMU Move_Area Command

See the Usage Notes for information on placing a snapshot file on a different device or directory when your database is a single-file database and for information on how this qualifier interacts with the Root, File, and Directory qualifiers.

The Snapshot qualifier is a positional qualifier.

Spams

Nospams

Specifies whether to enable the creation of space area management (SPAM) pages or to disable the creation of SPAM pages (Nospams) for specified storage areas when converting read/write storage areas to write-once storage areas or vice versa. This qualifier is not permitted with a storage area that has a uniform page format.

When SPAM pages are disabled in a read/write storage area, the SPAM pages are initialized, but they are not updated.

The Spams qualifier is a positional qualifier.

Thresholds=(n,n,n)

Specifies new SPAM thresholds for the storage area to which it is applied (for a mixed page format storage area). The thresholds of a storage area with a uniform page format cannot be changed.

See the *Oracle Rdb7 Guide to Database Performance and Tuning* for information on setting SPAM thresholds.

The Thresholds qualifier is a positional qualifier.

Usage Notes

- To use the RMU Move_Area command for a database, you must have the RMU\$MOVE privilege in the root file access control list (ACL) for the database or have the OpenVMS SYSPRV or BYPASS privilege.
- You cannot disable extensions of snapshot (.snp) files.
- The parameter (file and area) qualifiers for the RMU Move_Area command have positional semantics. See Section 1.2 for more information on parameter qualifiers.
- The RMU Move_Area command provides four qualifiers, Directory, Root, File, and Snapshots, that allow you to specify the target for the moved files. The **target** can be just a directory, just a file name, or a directory and file name.

1.33 RMU Move_Area Command

If you use all or some of these four qualifiers, apply them as follows:

- If you want to move the database root, use the Root qualifier to indicate the target for the moved database root file.
- Use local application of the File qualifier to specify the target for the moved storage area or areas.
- Use local application of the Snapshots qualifier to specify the target for the moved snapshot file or files.
- Use the Directory qualifier to specify a default target directory. The default target directory is the directory to which all storage area and snapshot files not qualified with the File or Snapshot qualifier are moved. It is also the default directory for files qualified with the Root, File, or Snapshot qualifier if the target for these qualifiers does not include a directory specification.

Note the following when using these qualifiers:

- Global application of the File qualifier when the target specification includes a file name causes Oracle RMU to move all of the specified storage areas to different versions of the same file name. This creates a database that is difficult to manage.
- Global application of the Snapshot qualifier when the target specification includes a file name causes Oracle RMU to move all of the specified snapshot files to different versions of the same file name. This creates a database that is difficult to manage.
- Specifying a file name or extension with the Directory qualifier is permitted, but causes Oracle RMU to move all of the specified files (except those specified with the File or Root qualifier) to different versions of the same file name. Again, this creates a database that is difficult to manage.

See Example 6.

- You must specify the Root qualifier when you use the RMU Move_Area command on a single-file database. If you omit the Root qualifier, you receive an error message. If you want to place the snapshot file for a single-file database on a different device or directory from the root file, Oracle Corporation recommends that you create a multifile database. However, you can work around this restriction by defining a search list for a concealed logical name. (However, do not use a nonconcealed rooted logical name to define database files; a database created with a non-concealed rooted logical name can be backed up, but may not restore correctly when you attempt to restore the files to a new directory.)

1.33 RMU Move_Area Command

To create a single-file database with a snapshot file on a different device or directory from the root file, define a search list by using a concealed logical name. Specify the location of the root file as the first item in the search list. When you create the database, use the logical name for the directory specification. Then, copy the snapshot file to the second device. The following example demonstrates the workaround:

```
$ ! Define a concealed logical name.
$ DEFINE /TRANS=CONCEALED/SYSTEM TESTDB USER$DISK1:[DATABASE], -
_ $ USER$DISK2:[SNAPSHOT]
$
$ SQL
SQL> ! Create the database.
SQL> !
SQL> CREATE DATABASE FILENAME TESTDB:TEST;
SQL> EXIT
$ !
$ ! Copy the snapshot file to the second disk.
$ COPY USER$DISK1:[DATABASE]TEST.SNP USER$DISK2:[SNAPSHOT]TEST.SNP
$ !
$ ! Delete the snapshot file from the original disk.
$ DELETE USER$DISK1:[DATABASE]TEST.SNP;
```

- There are no restrictions on the use of the Nospams qualifier option with mixed page format storage areas, but the use of the Nospams qualifier typically causes severe performance degradation. The Nospams qualifier is useful only where updates are rare and batched, and access is primarily by database key (dbkey).

Examples

Example 1

If a storage area is on a disk that is logging error messages, you can move the storage area to another disk by using the RMU Move_Area command. The following command moves the DEPARTMENTS storage area (departments.rda) and the DEPARTMENTS snapshot file (departments.snp) of the mf_personnel database to the DDV21:[RICK.SQL] directory:

```
$ RMU/MOVE_AREA MF_PERSONNEL DEPARTMENTS /DIRECTORY=DDV21:[RICK.SQL]
```

Example 2

The following command moves the EMPIDS_LOW, EMPIDS_MID, and EMPIDS_OVER storage areas for the mf_personnel database to the DISK2:[USER2] directory. The Extension=Disable qualifier disables automatic file extensions for the EMPIDS_LOW, EMPIDS_MID, and EMPIDS_OVER storage area (.rda) files when they are moved to the DISK2:[USER2] directory:

1.33 RMU Move_Area Command

```
$ RMU/MOVE_AREA/EXTENSION=DISABLE/DIRECTORY=DISK2:[USER2] -  
_$_ mf_personnel EMPIDS_LOW,EMPIDS_MID,EMPIDS_OVER
```

Example 3

The following RMU Move_Area command uses an options file to specify that the storage area files and snapshot files be moved to different disks. Note that storage area snapshot (.snp) files are located on different disks from one another and from their associated storage area (.rda) files; this is recommended for optimal performance. (This example assumes that the disks specified for each storage area file in options_file.opt are different from those where the storage area files currently reside.)

```
$ RMU/MOVE_AREA/OPTIONS=OPTIONS_FILE.OPT MF_PERSONNEL
```

The following command displays the contents of the options file:

```
$ TYPE options_file.opt  
EMPIDS_LOW /FILE=DISK1:[CORPORATE.PERSONNEL]EMPIDS_LOW.RDA -  
/SNAPSHOT=(FILE=DISK2:[CORPORATE.PERSONNEL]EMPIDS_LOW.SNP)  
EMPIDS_MID /FILE=DISK3:[CORPORATE.PERSONNEL]EMPIDS_MID.RDA -  
/SNAPSHOT=(FILE=DISK4:[CORPORATE.PERSONNEL]EMPIDS_MID.SNP)  
EMPIDS_OVER /FILE=DISK5:[CORPORATE.PERSONNEL]EMPIDS_OVER.RDA -  
/SNAPSHOT=(FILE=DISK6:[CORPORATE.PERSONNEL]EMPIDS_OVER.SNP)  
DEPARTMENTS /FILE=DISK7:[CORPORATE.PERSONNEL]DEPARTMENTS.RDA -  
/SNAPSHOT=(FILE=DISK8:[CORPORATE.PERSONNEL]DEPARTMENTS.SNP)  
SALARY_HISTORY /FILE=DISK9:[CORPORATE.PERSONNEL]SALARY_HISTORY.RDA -  
/SNAPSHOT=(FILE=DISK10:[CORPORATE.PERSONNEL]SALARY_HISTORY.SNP)  
JOBS /FILE=DISK7:[CORPORATE.PERSONNEL]JOBS.RDA -  
/SNAPSHOT=(FILE=DISK8:[CORPORATE.PERSONNEL]JOBS.SNP)  
EMP_INFO /FILE=DISK9:[CORPORATE.PERSONNEL]EMP_INFO.RDA -  
/SNAPSHOT=(FILE=DISK10:[CORPORATE.PERSONNEL]EMP_INFO.SNP)  
RESUME_LISTS /FILE=DISK11:[CORPORATE.PERSONNEL]RESUME_LISTS.RDA -  
/SNAPSHOT=(FILE=DISK12:[CORPORATE.PERSONNEL]RESUME_LISTS.SNP)  
RESUMES /FILE=DISK9:[CORPORATE.PERSONNEL]RESUMES.RDA -  
/SNAPSHOT=(FILE=DISK10:[CORPORATE.PERSONNEL]RESUMES.SNP)
```

Example 4

The following RMU Move_Area command moves the database root for the mf_personnel database and defines a new after-image journal configuration, using the Aij_Options qualifier:

```
$ RMU/MOVE_AREA/ROOT=DISK1:[DATABASE.PERSONNEL]MF_PERSONNEL -  
_$_ /AIJ_OPTIONS=aij_config.opt MF_PERSONNEL/NOONLINE
```

1.33 RMU Move_Area Command

The `aij_config.opt` file contains the following clauses:

```
JOURNAL IS ENABLED -  
  RESERVE 2 -  
  ALLOCATION IS 512 -  
  EXTENT IS 512 -  
  OVERWRITE IS DISABLED -  
  SHUTDOWN_TIMEOUT IS 120 -  
  NOTIFY IS DISABLED -  
  BACKUPS ARE MANUAL -  
  CACHE IS DISABLED  
ADD AIJ1 -  
  FILE DISK2:[MFPERS_AIJ1]AIJ_ONE  
ADD AIJ2 -  
  FILE DISK3:[MFPERS_AIJ2]AIJ_TWO
```

Example 5

The following example moves all the `mf_personnel` database storage areas to the `DISK3:[db]` directory:

```
$ RMU/MOVE_AREA MF_PERSONNEL.RDB /ALL_AREAS/DIR=DISK3:[DB]
```

Example 6

The following example demonstrates the use of the Directory, File, and Root qualifiers. In this example:

- The default directory is specified as `DISK2:[DIR]`.
- The target directory and file name for the database root file is specified with the Root qualifier. The target directory specified with the Root qualifier overrides the default directory specified with the Directory qualifier. Thus, Oracle RMU moves the database root to `DISK3:[ROOT]` and names it `MOVEDRDB.RDB`.
- The target directory for the `EMPIDS_MID` storage area is `DISK4:[FILE]`. Oracle RMU moves `EMPIDS_MID` to `DISK4:[FILE]`.
- The target file name for the `EMPIDS_LOW` storage area is `EMPIDS`. Thus, Oracle RMU moves the `EMPIDS_LOW` storage area to the `DISK2` default directory (specified with the Directory qualifier), and names the file `EMPIDS.RDA`.
- The target for the `EMPIDS_LOW` snapshot file is `DISK5:[SNAP]EMPIDS.SNP`. Thus, Oracle RMU moves the `EMPIDS_LOW` snapshot file to `DISK5:[SNAP]EMPIDS.SNP`.

1.33 RMU Move_Area Command

- All the other storage area files and snapshot files in the mf_personnel database are moved to DISK2:[DIR]; the file names for these storage areas remain unchanged.

```
$ RMU/MOVE_AREA DISK1:[DB]MF_PERSONNEL.RDB /ALL-  
_$_ /DIRECTORY=DISK2:[DIR] -  
_$_ /ROOT=DISK3:[ROOT]MOVEDRDB.RDB -  
_$_ EMPIDS_MID/FILE=DISK4:[FILE], -  
_$_ EMPIDS_LOW/FILE=EMPIDS -  
_$_ /SNAPSHOT=(FILE=DISK5:[SNAP]EMPIDS.SNP)
```

1.34 RMU Open Command

1.34 RMU Open Command

Opens a database root file and maps its global section to the contents of an OpenVMS virtual address file. You can use the RMU Open command in conjunction with the SQL ALTER DATABASE statement to control access to the database. See the description of the OPEN IS {AUTOMATIC | MANUAL} clause of the SQL ALTER DATABASE statement in the *Oracle Rdb SQL Reference Manual* for details.

Format

<u>Command Qualifiers</u>	<u>Default</u>
/Access=[Un]Restricted	See description
/Global_Buffers[=(Total=i,User_Limit=j)]	See description
/Path	None
/Row_Cache=Disable	See description
/[No]Statistics=Import	/Nostatistics
/[No]Wait	/Nowait

Description

Once you use the RMU Open command to open a database, the database remains open and mapped until you close it explicitly with an RMU Close command and all users have exited the database with the SQL DISCONNECT or EXIT statements. If you do not issue the RMU Open command, the first user to attach to the database incurs the cost of implicitly opening it and the last user to detach from the database incurs the cost of implicitly closing it.

The effect of the RMU Open command depends on whether you have specified the OPEN IS AUTOMATIC or OPEN IS MANUAL clause to the SQL ALTER DATABASE statement, as follows:

- OPEN IS AUTOMATIC

If you have specified automatic opening for your database, users can invoke the database at any time without first issuing an RMU Open command. (Although as mentioned above, it is more efficient to explicitly open the database with an RMU Open command and close it with an RMU Close command.)

1.34 RMU Open Command

- **OPEN IS MANUAL**

If you have specified manual opening for your database, the RMU Open command must be issued before users can invoke the database.

If you modify the database attribute from OPEN IS AUTOMATIC to OPEN IS MANUAL, the modification takes effect only after all users have detached from the database. (You can issue the RMU/CLOSE/ABORT=FORCEX command to force all users to detach.) Then, you must issue the RMU Open command before users can invoke the database.

If you modify the database attribute from OPEN IS MANUAL to OPEN IS AUTOMATIC, users can invoke the database at their discretion. You do not have to issue the RMU Open command. However, if a user has already opened the database manually when you make this change to the database attribute, the modification takes effect only after you manually close the database by issuing the RMU Close command.

See the *Oracle Rdb Guide to Database Maintenance* for information to help you decide whether to set your database attribute to automatic or manual opening.

When you create a database, you have a choice of how to set up buffers for database pages. You can choose either local or global buffering. Global buffers can provide better system performance. See the *Oracle Rdb7 Guide to Database Performance and Tuning* for more information on setting the number of global buffers for your system.

Command Parameters

root-file-spec[,...]

Specifies the database to open. If the database root file is open, you receive an informational message. The default file extension is .rdb.

Command Qualifiers

Access=Restricted

Access=Unrestricted

Permits the database administrator to open the database and restrict access to it in order to perform maintenance operations or to restructure the database without interference from users who want to gain access. If access is restricted (Access=Restricted), the DBADM privilege is required for SQL access to the database. If the Access=Unrestricted qualifier is specified, users without the DBADM privilege can attach to the database.

1.34 RMU Open Command

Note

Do not confuse the Oracle RMU Access=Restricted qualifier with the SQL restricted access clause (available for use with the following SQL statements: ATTACH, CREATE, DECLARE ALIAS, and IMPORT). When you specify the restricted access clause in SQL, only one user can attach to the database; when you specify the Access=Restricted qualifier using Oracle RMU, any number of users with the DBADM privilege can access the database.

Furthermore, note that an SQL SHOW DATABASE command displays the phrase “No Restricted Access” or the phrase “Restricted Access” if access has been restricted using the SQL restricted access clause. However, SHOW DATABASE tells you nothing about whether Oracle RMU has opened a database with access restricted. Use the RMU Dump command to view the Oracle RMU access setting.

Refer to the *Oracle Rdb SQL Reference Manual* for more information on the SQL restricted access clause.

If you specify the RMU Open command without the Access qualifier, Oracle RMU opens the database in the same access mode as the last RMU Open command performed. If the database was last opened as restricted, issuing the RMU Dump command results in the following message being displayed:

```
Access restricted to privileged users
```

Use this form of the RMU Open command to open the database on other nodes without changing the access mode.

The access mode is clusterwide and the last mode set with the RMU Open command is used for the entire cluster.

For example, if you open the mf_personnel database on node A with the Access=Unrestricted qualifier, and open the same database on node B with the Access=Restricted qualifier, the database has restricted access on both node A and node B. However, the commands do not terminate any user processes that may have gained access while the database was unrestricted.

The access mode is stored in the database. Consequently, if the system fails while access is restricted, access remains restricted unless the unrestricted mode is explicitly requested. The RMU Backup, RMU Restore, and RMU Copy_Database commands also preserve the access mode.

1.34 RMU Open Command

The RMU Close command does not alter the access mode. You can change the mode by using the RMU Open command only. You can use the RMU Open command to restrict access to any database, whether it was opened as AUTOMATIC or MANUAL.

The Access qualifier is a positional qualifier.

Global_Buffers[=(Total=i,User_Limit=j)]

Allows you to set the basic global buffer parameters on each RMU Open command. If you specify the Global_Buffers qualifier, you can optionally specify values for the Total and User_Limit parameters:

- Total is the number of global buffers per node to allocate for this opened instance of the database (minimum = 5, and maximum = 32,768).
- User_Limit is the maximum number of global buffers to be allotted to any given user (minimum = 5, maximum = Total).

The default values for Total and User_Limit are set by:

- The RMU Open command explicitly
- Values determined at the time the database was created

If you do not specify a value for the Total or User_Limit options, the values are determined based on what they were when the database was created.

If a database does not have global buffers enabled, the Global_Buffers qualifier is ignored. Use the RMU Dump command to see if global buffering is enabled or disabled. The RMU Dump command also shows the global buffer count and the maximum global buffer count per user. For example:

```
$ RMU/DUMP MF_PERSONNEL
*-----
* Oracle Rdb V7.0-00                22-SEP-1995 10:11:51.14
*
* Dump of Database header
*   Database: DISK1:[DATABASE]MF_PERSONNEL.RDB;1
*
*-----
```

1.34 RMU Open Command

```
Database Parameters:
  Root filename is "DISK1:[DATABASE]MF_PERSONNEL.RDB;1"
  Created at 7-APR-1994 16:50:09.01
  Oracle Rdb structure level is 70.0
  Maximum user count is 50
  Maximum node count is 16
  Database open mode is AUTOMATIC
  Database close mode is AUTOMATIC
  Database is available for READ WRITE access
  Snapshot mode is NON-DEFERRED
  Statistics are enabled
  Storage Areas...
    - Active storage area count is 10
    - Reserved storage area count is 0
  Buffers...
    - Default user buffer count is 20
    - Default recovery buffer count is 20
    - Global buffers are enabled <-----
    - Global buffer count is 250 <-----
    - Maximum global buffer count per user is 5 <-----
    - Buffer size is 6 blocks
  .
  .
  .
  Derived Data...
    - Global section size
      With global buffers disabled is 70962 bytes
      With global buffers enabled is 975992 bytes
  .
  .
  .
```

The `Global_Buffers` qualifier is a positional qualifier.

Path

Specifies the full or relative data dictionary path name in which the definitions reside for the database you want to open.

The `Path` qualifier is a positional qualifier. The path name cannot include wildcard characters.

Row_Cache=Disable

Disables row caching. This qualifier is provided for use with hot standby databases. Row caching cannot be enabled on a hot standby database while replication is active. If it is enabled, the hot standby feature will not start.

1.34 RMU Open Command

Statistics=Import Nostatistics

Specifies that statistic information previously saved by using the Statistics=Export qualifier on the RMU Close command is to be loaded when the database is opened. The default is Nostatistics, which indicates that statistic information is not loaded when the database is opened.

After the database is opened using the Statistics=Import qualifier, the saved statistics file is closed. The statistics file is not automatically deleted. It can be deleted if it is no longer needed.

When you use the Statistics=Import qualifier, statistics information is automatically preserved in the event of abnormal database closure. To ensure that the ondisk statistic information files are accurate in the case of a node or monitor failure, the statistic information files are checkpointed by the database monitor every half-hour. The RMU Show Users command identifies when the checkpoint for each database occurs.

The statistic files are not loaded if the physical schema of the database has changed since the statistic file was created. This means that the addition or deletion of storage areas, logical areas, and record caches invalidate the statistic files. This restriction prevents incorrect statistic information from being loaded when intervening physical changes occur to the database. Closing the database updates the statistic files and makes them valid. Use the RMU Show Users command to verify that the statistic information file was imported.

Wait Nowait

Specifies whether the system prompt should be returned before the database is completely open and available. Specify the Wait qualifier if you want the system prompt returned when the database is completely open and available. Specify Nowait if you want the system prompt returned immediately, regardless of the state of the open operation.

The Nowait qualifier is the default.

Usage Notes

- To use the RMU Open command for a database, you must have the RMU\$OPEN privilege in the root file access control list (ACL) for the database or the OpenVMS WORLD privilege.

1.34 RMU Open Command

Examples

Example 1

The following command opens the mf_personnel database:

```
$ RMU/OPEN MF_PERSONNEL
```

Example 2

The following command opens the mf_personnel database in the WORK directory, all the databases in the .TEST directory, and the databases specified by the path names CDD\$TOP.FINANCE and SAMPLE_DB:

```
$ RMU/OPEN DISK1:[WORK]MF_PERSONNEL, CDD$TOP.FINANCE/PATH, -  
_ $ DISK1:[TEST]*, SAMPLE_DB/PATH
```

Example 3

This command opens the mf_personnel database, sets the total global buffers for this opened instance of the database, and sets the maximum number of global buffers that can be given to any user. This example limits the number of users who can access this database at any given time to 2 (Total divided by User_Limit). You may want to increase the values of Total and User_Limit.

```
$ RMU/OPEN MF_PERSONNEL/GLOBAL_BUFFERS=(TOTAL=10,USER_LIMIT=5)
```

If you define a user limit value that is greater than the value you specify for Total, you receive an error message:

```
$ RMU/OPEN MF_PERSONNEL/GLOBAL=(TOTAL=5,USER_LIMIT=10)  
%RMU-F-VALGTRMAX, value (10) is greater than maximum allowed  
value (5) for GLOBAL_BUFFERS.USER_LIMIT
```

Example 4

This command disables row caching.

```
$ RMU/OPEN MF_PERSONNEL.RDB /ROW_CACHE=DISABLE
```

1.35 RMU Optimize After_Journal Command

1.35 RMU Optimize After_Journal Command

Optimizes a backed up after-image journal (.aij) file for database recovery (rollforward) operations by eliminating unneeded and duplicate journal records, and by ordering journal records. An optimized .aij (.oaij) file created by the RMU Optimize After_Journal command provides better recovery performance for your database than an .aij file. A benefit of this improved recovery performance is that the database is made available to users sooner.

The RMU Optimize After_Journal command is used to read a backed up .aij file on disk and write the .oaij file to tape or disk.

Format

RMU/Optimize/After_Journal aij-file optimized-aij-file

Command Qualifiers

/[No]Accept_Label
/Active_IO=max-writes
/Block_Size=integer
/Crc[=Autodin_II]
/Crc=Checksum
/Nocrc
/Density=density-value[, [No]Compaction]
/Encrypt={Value=|Name=}{, Algorithm=}
/Format={Old_File|New_Tape}
/[No]Group_Size=interval
/Label=(label-name-list)
/Librarian[=options]
/[No]Log
/[No]Media_Loader
/Owner=user-id
/Protection[=openvms-file-protection]

/Recovery_Method[=(Sequential|Scatter)]
/[No]Rewind
/Tape_Expiration=date-time
/[No]Trace

Defaults

/Noaccept_Label
/Active_IO=3
See description
See description
See description
See description
See description
See description
/Format=Old_File
See description
See description
None
Current DCL verify value
See description
See description
See description

/Recovery_Method=Sequential
/Norewind
The current time
/Notrace

1.35 RMU Optimize After_Journal Command

Description

The RMU Optimize After_Journal command performs the following optimizations to backed up .aij files:

- The .aij records from transactions that rolled back are eliminated.
Because transactions that are rolled back in an .aij file are not needed in a recovery operation, they are not part of an optimized .aij file.
- Duplicate .aij records are eliminated.
Duplicate .aij records are .aij records that update the same database record. During the rollforward of an .aij file, duplicate .aij records cause a database record to be updated multiple times. Each update supersedes the previous update, meaning only the last update is relevant. Therefore, all but the last update to a database record can be eliminated from an .aij file.
- The .aij records are ordered by physical database key (dbkey).
Ordering .aij records by physical dbkey improves I/O performance at recovery time.

See the *Oracle Rdb Guide to Database Maintenance* for further description of optimizing .aij files.

The RMU Optimize After_Journal command has the following restrictions:

- You can only optimize quiet-point .aij backup files.
- You cannot optimize a current .aij file.
- You cannot optimize an .oaij file.

Note

Because an .oaij file is not functionally equivalent to the original .aij file, the original .aij file should not be discarded after it has been optimized.

- You cannot use .oaij files with the following types of recovery operations:
 - By-area recovery operations (recovery operations that use the RMU Recover command with the Areas qualifier).
 - By-page recovery operations (recovery operations that use the RMU Recover command with the Just_Corrupt qualifier).

1.35 RMU Optimize After_Journal Command

- RMU Recover commands with the Until qualifier. The .oaij file does not retain enough of the information from the original .aij file for such an operation.
- Recovery operation where the database or any storage areas (or both) are inconsistent with the .oaij file. A database or storage area will be inconsistent with the .oaij file if the transaction sequence number (TSN) of the last committed transaction of the database or storage area is not equal to the TSN of the last committed transaction in the open record of the .aij file. The last committed TSN in the .oaij file represents the last transaction committed to the database at the time the original .aij file was created.

As a workaround for these restrictions against using .oaij files in these recovery operations, use the original, unoptimized .aij files in these recovery operations instead.

- Any .aij file that possibly contains incomplete transactions cannot be optimized. Incomplete transactions can occur in an .aij file under the following circumstances:
 - The .aij file is backed up with a no-quiet-point backup operation (because transactions can span .aij files)
Note that transactions in a fixed-size journal configuration may span .aij files. Thus, if each journal in a fixed-size journal configuration has been backed up on a per-journal basis, the resulting files are equivalent to a no-quiet-point .aij backup operation. These .aij backup files cannot be optimized unless you perform a manual quiet-point backup operation first. A quiet-point backup operation forces a switch-over to another available .aij file which ensures that no transaction spans two journal files.
 - The previous .aij file was backed up with a no-quiet-point backup operation
 - The .aij file has unresolved distributed transactions

There are no workarounds to these restrictions against optimizing .aij files with incomplete transactions.

Command Parameters

aij-file

The name of the .aij file that you want to optimize. It cannot be a current .aij file.

The default file extension is .aij.

1.35 RMU Optimize After_Journal Command

optimized-aij-file

The name of the optimized .aij file to be produced by the RMU Optimize After_Journal command.

The default file extension is .aij.

Command Qualifiers

Accept_Label

Specifies that Oracle RMU should keep the current tape label it finds on a tape during an optimize-to-tape operation even if that label does not match the default label or that specified with the Label qualifier. Operator notification does not occur unless the tape's protection, owner, or expiration date prohibit writing to the tape. However, a message is logged (assuming logging is enabled) to indicate that a label is being preserved and which drive currently holds that tape.

This qualifier is particularly useful when your optimize-to-tape operation employs numerous previously used (and thus labeled) tapes and you want to preserve the labels currently on the tapes.

If you do not specify this qualifier, the default behavior of Oracle RMU is to notify the operator each time it finds a mismatch between the current label on the tape and the default label (or the label you specify with the Label qualifier).

See the description of the Labels qualifier in this section for information on default labels. See Table 1–5 for a summary of which labels are applied under a variety of circumstances.

Active_IO=max-writes

Specifies the maximum number of write operations to the .aij file device that the RMU Optimize After_Journal command will attempt simultaneously. This is not the maximum number of write operations in progress; that value is the product of active system I/O operations and the number of devices being written to simultaneously.

The value of the Active_IO qualifier can range from 1 to 5. The default value is 3. Values larger than 3 might improve performance with some tape drives.

Block_Size=integer

Specifies the maximum record size for the optimized .aij file. The size can vary between 2048 and 65,024 bytes. The default value is device dependent. The appropriate block size is a compromise between tape capacity and error rate. The block size you specify must be larger than the largest page length in the database.

1.35 RMU Optimize After_Journal Command

Crc=Autodin_II]

Uses the AUTODIN-II polynomial for the 32-bit cyclic redundancy check (CRC) calculation and provides the most reliable end-to-end error detection. This is the default for NRZ/PE (800/1600 bits/inch) tape drives.

Typing the Crc qualifier is sufficient to select the Crc=Autodin_II option. It is not necessary to type the entire qualifier.

Crc=Checksum

Uses one's complement addition, which is the same computation used to do a checksum of the AIJ data on disk. This is the default for GCR (6250 bits/inch) tape drives and for TA78, TA79, and TA81 drives.

The Crc=Checksum qualifier allows detection of data errors.

Nocrc

Disables end-to-end error detection. This is the default for TA90 (IBM 3480 class) drives.

Note

The overall effect of the Crc=Autodin_II, Crc=Checksum, and Nocrc defaults is to make tape reliability equal to that of a disk. If you retain your tapes longer than 1 year, the Nocrc default might not be adequate. For tapes retained longer than 1 year, use the Crc=Checksum qualifier.

If you retain your tapes longer than 3 years, you should always use the Crc=Autodin_II qualifier.

Tapes retained longer than 5 years could be deteriorating and should be copied to fresh media.

See the *Oracle Rdb Guide to Database Maintenance* for details on using the Crc qualifiers to avoid underrun errors.

Density=density-value[, [No]Compaction]

Specifies the density at which the output volume is to be written. The default value is the format of the first volume (the first tape you mount). You do not need to specify this qualifier unless your tape drives support data compression or more than one recording density.

The Density qualifier is applicable only to tape drives. Oracle RMU returns an error message if this qualifier is used and the target device is not a tape drive.

1.35 RMU Optimize After_Journal Command

If your systems are running OpenVMS versions prior to 7.2-1, specify the Density qualifier as follows:

- For TA90E, TA91, and TA92 tape drives, specify the number in bits per inch as follows:
 - Density = 70000 to initialize and write tapes in the compacted format
 - Density = 39872 or Density = 40000 for the noncompacted format
- For SCSI (Small Computer System Interface) tape drives, specify Density = 1 to initialize and write tapes, using the drive's hardware data compression scheme.
- For other types of tape drives, you can specify a supported Density value between 800 and 160,000 bits per inch.
- For all tape drives, specify Density = 0 to initialize and write tapes at the drive's standard density.

Do not use the Compaction or NoCompaction keyword for systems running OpenVMS versions prior to 7.2-1. On these systems, compression is determined by the density value and cannot be specified.

Oracle RMU supports the OpenVMS tape density and compression values introduced in OpenVMS Version 7.2-1. The following table lists the added density values supported by Oracle RMU.

DEFAULT	800	833	1600
6250	3480	3490E	TK50
TK70	TK85	TK86	TK87
TK88	TK89	QIC	8200
8500	8900	DLT8000	
SDLT	SDLT320		
DDS1	DDS2	DDS3	DDS4
AIT1	AIT2	AIT3	AIT4
COMPACTION	NOCOMPACTION		

If the OpenVMS Version 7.2-1 density values and the previous density values are the same (for example, 800, 833, 1600, 6250), the specified value is interpreted as an OpenVMS Version 7.2-1 value if the tape device driver accepts them, and as a previous value if the tape device driver accepts previous values only.

1.35 RMU Optimize After_Journal Command

For the OpenVMS Version 7.2-1 values that accept tape compression you can use the following syntax:

```
/DENSITY = (new_density_value, [No]Compaction)
```

In order to use the `Compaction` or `NoCompaction` keyword, you must use one of the following density values that accepts compression:

1.35 RMU Optimize After_Journal Command

DEFAULT	3480	3490E	8200
8500	8900	TK87	TK88
TK89	DLT8000	SDLT	SDLT320
AIT1AIT2	AIT3	AIT4	
DDS1	DDS2	DDS3	DDS4

Refer to the OpenVMS documentation for more information about density values.

Encrypt={Value= | Name=}[,Algorithm=]

The Encrypt qualifier decrypts the backup file of the optimized after-image journal file.

Specify a key value as a string or, the name of a predefined key. If no algorithm name is specified the default is DESCBC. For details on the Value, Name and Algorithm parameters see HELP ENCRYPT.

This feature requires the OpenVMS Encrypt product to be installed and licensed on this system.

This feature only works for a newer format backup file which has been created using the Format=New_Tape qualifier. Therefore you have to specify the Format=New_Tape qualifier with this command if you also use the Encrypt qualifier.

Format=Old_Rms

Format=New_Tape

Synonymous with the Format=Old_File and Format=New_Tape qualifiers. See the description of those qualifiers.

Format=Old_File

Format=New_Tape

The Format qualifier allows you to specify the format of the files written by the RMU Optimize After_Journal command.

If you specify the default, Format=Old_File, the RMU Optimize After_Journal command writes files in RMS format. This format is provided for compatibility with prior versions of Oracle Rdb. If you specify Format=Old_File, you must mount the media by using the DCL MOUNT command before you issue the RMU Optimize After_Journal command. Because the RMU Optimize After_Journal command will use RMS to write to the tape, the tape must be mounted as an OpenVMS volume (that is, do not specify the /FOREIGN qualifier with the MOUNT command).

1.35 RMU Optimize After_Journal Command

If you specify FOREIGN access although your backup file was created using the Format=Old_File qualifier, you will not receive an error message. The tape will be considered unlabeled, and thus the operation will process whatever data is at the current position of the tape (labels, data, or something else). A failure will occur, but what will fail and how it will fail is unpredictable because the type of information that will be read is unknown. The result is an unlabeled tape that can be difficult to use for recovery operations.

If you specify Format=New_Tape, the RMU Optimize After_Journal command writes .aij files in a format similar to that used by an RMU Backup command. If you specify Format=New_Tape, you must mount the media by using the DCL MOUNT command before you issue the RMU Optimize After_Journal command. The tape must be mounted as a FOREIGN volume.

The following tape qualifiers have meaning only when used in conjunction with the Format=New_Tape qualifier:

- Active_IO
- Block_Size
- Crc
- Group_Size
- Density
- Label
- Owner_Uic
- Protection
- Rewind
- Tape_Expiration

Follow these steps when you optimize an .aij file to tape:

1. Use the RMU Backup After_Journal command with the Format=Old_File qualifier to back up the .aij file to disk.
2. Use the RMU Optimize After_Journal command with the Format=New_Tape qualifier to optimize the backed up .aij file to tape.
3. Use the DCL BACKUP command to create a copy of the backed up .aij file as insurance.

If you enter the RMU Optimize After_Journal command with no Format qualifier, the default is Format=Old_File.

Group_Size=interval

Nogroup_Size

Specifies the frequency at which XOR recovery blocks are written to tape. The group size can vary from 0 to 100. Specifying a group size of zero or specifying the Nogroup_Size qualifier results in no XOR recovery blocks being written.

1.35 RMU Optimize After_Journal Command

The `Group_Size` qualifier is applicable only to tape, and its default value is device dependent. Oracle RMU returns an error message if this qualifier is used and the target device is not a tape device.

Label=(label-name-list)

Specifies the 1- to 6-character string with which the volumes of the `.oaij` file are to be labeled. The `Label` qualifier is applicable only to tape volumes. You must specify one or more label names when you use the `Label` qualifier.

You can specify a list of tape labels for multiple tapes. If you list multiple tape label names, separate the names with commas, and enclose the list of names within parentheses.

Use the label that you specify for the `RMU Optimize After_Journal` command when you issue the `RMU Recover` command.

The `Label` qualifier can be used with indirect file references. See Section 1.3 for more information.

Librarian[=options]

Use the `Librarian` qualifier to back up files to data archiving software applications that support the Oracle Media Management interface. The backup file name specified on the command line identifies the stream of data to be stored in the `Librarian` utility. If you supply a device specification or a version number it will be ignored.

The `Librarian` qualifier accepts the following options:

- `Trace_file=file-specification`
The `Librarian` utility writes trace data to the specified file.
- `Level_Trace=n`
Use this option as a debugging tool to specify the level of trace data written by the `Librarian` utility. You can use a pre-determined value of 0, 1, or 2, or a higher value defined by the `Librarian` utility. The pre-determined values are :
 - Level 0 traces all error conditions. This is the default.
 - Level 1 traces the entry and exit from each `Librarian` function.
 - Level 2 traces the entry and exit from each `Librarian` function, the value of all function parameters, and the first 32 bytes of each read/write buffer, in hexadecimal.
- `Logical_Names=(logical_name=equivalence-value,...)`

1.35 RMU Optimize After_Journal Command

You can use this option to specify a list of process logical names that the Librarian utility can use to specify catalogs or archives where Oracle Rdb backup files are stored, Librarian debug logical names, and so on. See the specific Librarian documentation for the definition of logical names. The list of process logical names is defined by Oracle RMU prior to the start of any Oracle RMU command that accesses the Librarian utility.

The following OpenVMS logical names must be defined for use with a Librarian utility before you execute an Oracle RMU backup or restore operation. Do not use the `Logical_Names` option provided with the Librarian qualifier to define these logical names.

- **RMU\$LIBRARIAN_PATH**

This logical name must be defined so that the shareable Librarian image can be loaded and called by Oracle RMU backup and restore operations. The translation must include the file type (for example, `.exe`), and must not include a version number. The shareable Librarian image must be an installed (known) image. See the Librarian utility documentation for the name and location of this image and how it should be installed.

- **RMU\$DEBUG_SBT**

This logical name is not required. If it is defined, Oracle RMU will display debug tracing information messages from modules that make calls to the Librarian shareable image.

You cannot use device specific qualifiers such as `Rewind`, `Density`, or `Label` with the Librarian qualifier because the Librarian utility handles the storage media, not Oracle RMU.

Log

Nolog

Specifies that the optimization of the `.ajj` file be reported to `SYS$OUTPUT`. When optimization activity is logged, the output from the `Log` qualifier provides the number of transactions committed and rolled back. You can specify the `Trace` qualifier with the `Log` qualifier. The default is the setting of the `DCL VERIFY` flag, which is controlled by the `DCL SET VERIFY` command.

Media Loader

Nomedia Loader

Use the `Media Loader` qualifier to specify that the tape device receiving the backup file has a loader or stacker. Use the `Nomedia Loader` qualifier to specify that the tape device does not have a loader or stacker.

1.35 RMU Optimize After_Journal Command

By default, if a tape device has a loader or stacker, Oracle RMU should recognize this fact. However, occasionally Oracle RMU does not recognize that a tape device has a loader or stacker. Therefore, when the first backup tape fills, Oracle RMU issues a request to the operator for the next tape, instead of requesting the next tape from the loader or stacker. Similarly, sometimes Oracle RMU behaves as though a tape device has a loader or stacker when actually it does not.

If you find that Oracle RMU is not recognizing that your tape device has a loader or stacker, specify the `Media_Loader` qualifier. If you find that Oracle RMU expects a loader or stacker when it should not, specify the `Nomedia_Loader` qualifier.

Owner_Uic=user-id

Synonymous with the `Owner` qualifier. See the description of the `Owner` qualifier.

Owner=user-id

Specifies the owner of the tape volume set. The owner is the user who will be permitted to recover (roll forward) the database. The `user-id` parameter must be one of the following types of OpenVMS identifier:

- A user identification code (UIC) in [group-name,member-name] alphanumeric format
- A UIC in [group-number,member-number] numeric format
- A general identifier, such as `SECRETARIES`
- A system-defined identifier, such as `DIALUP`

When used with tapes, the `Owner` qualifier applies to all continuation volumes. The `Owner` qualifier applies to the first volume only if the `Rewind` qualifier is also specified. If the `Rewind` qualifier is not specified, the optimization operation appends the file to a previously labeled tape, so the first volume can have a different protection than the continuation volumes.

Protection[=openvms-file-protection]

Specifies the system file protection for the `.oaij` file produced by the RMU `Optimize After_Journal` command.

The default file protection varies, depending on whether you write the `.oaij` file to disk or tape. This is because tapes do not allow delete or execute access and the `SYSTEM` account always has both read and write access to tapes. In addition, a more restrictive class accumulates the access rights of the less restrictive classes.

1.35 RMU Optimize After_Journal Command

If you do not specify the Protection qualifier, the default protection is as follows:

- S:RWED,O:RE,G,W if the .oaij file is written to disk
- S:RW,O:R,G,W if the .oaij file is written to tape

If you specify the Protection qualifier explicitly, the differences in protection applied for backups to tape or disk as noted in the preceding paragraph are applied. Thus, if you specify Protection=(S,O,G:W,W:R), that protection on tape becomes (S:RW,O:RW,G:RW,W:R).

Recovery_Method[=(Sequential | Scatter)]

Specifies how .aij records are to be ordered. You can specify one of two possible order types:

- Sequential—.aij records are ordered by physical dbkey in an area:page:line sequence. This order type is the default.
- Scatter—.aij records are ordered by a sort key of page:area:line (page number, area number, and line number). This order can allow the RMU Recover command to perform more effective I/O prefetching and writing to multiple storage areas simultaneously, typically where storage areas of the database are distributed among multiple disk devices.

Scatter ordering allows more disk devices to be active during the recovery process. This helps reduce idle CPU time and allows the recovery to complete in less time. However, because database configurations vary widely, Oracle recommends that you perform tests with both Scatter and Sequential ordering of the optimized after-image journals to determine which method produces the best results for your system.

Rewind

Norewind

Specifies that the tape that will contain the .oaij file be rewound before processing begins. The tape will be initialized according to the Label qualifier. The Norewind qualifier is the default and causes the optimized .oaij file to be written starting at the current logical end-of-tape (EOT).

The Norewind and Rewind qualifiers are applicable only to tape devices. Oracle RMU returns an error message if these qualifiers are used and the target device is not a tape device.

Tape_Expiration=date-time

Specifies the expiration date of the .oaij file on tape. Note that when Oracle RMU reads a tape, it looks at the expiration date in the file header of the first file on the tape and assumes the date it finds in that file header is the

1.35 RMU Optimize After_Journal Command

expiration date for the entire tape. Therefore, if you are writing an .oaij file to tape, specifying the Tape_Expiration qualifier only has meaning if the .oaij file is the first file on the tape. You can guarantee that the .oaij file will be the first file on the tape by specifying the Rewind qualifier and overwriting any existing files on the tape.

When the first file on the tape contains an expiration date in the file header, you cannot overwrite the tape before the expiration date unless you have the OpenVMS SYSPRV or BYPASS privilege.

Similarly, when you attempt to perform a recover operation with an .oaij file on tape, you cannot perform the recover operation after the expiration date recorded in the first file on the tape unless you have the OpenVMS SYSPRV or BYPASS privilege.

By default, no expiration date is written to the .oaij file header. In this case, if the .oaij file is the first file on the tape, the tape can be overwritten immediately. If the .oaij file is not the first file on the tape, the ability to overwrite the tape is determined by the expiration date in the file header of the first file on the tape.

You cannot explicitly set a tape expiration date for an entire volume. The volume expiration date is always determined by the expiration date of the first file on the tape. The Tape_Expiration qualifier cannot be used with a backup operation to disk.

Trace

Notrace

Specifies that the optimization of the .aij file be traced. The default is the Notrace qualifier, where optimization is not traced. When optimization is traced, the output from the Trace qualifier identifies transactions in the .aij file by transaction sequence numbers (TSNs) and describes what Oracle RMU did with each transaction during the optimization process. You can specify the Log qualifier with the Trace qualifier.

Usage Notes

- To use the RMU Optimize After_Journal command for a database, you must have the RMU\$BACKUP or RMU\$RESTORE privilege in the root file access control list (ACL) for the database or the OpenVMS SYSPRV or BYPASS privilege.

1.35 RMU Optimize After_Journal Command

- You cannot optimize an .aij file in the process of backing it up. You must first back up the .aij file, using the RMU Backup After_Journal command with the Format=Old_File qualifier, and then optimize it.
- As part of the optimization process, Oracle RMU sorts journal records by physical dbkey which improves I/O performance of the recovery. Because AIJ file optimization uses the OpenVMS Sort/Merge utility (SORT/MERGE) to sort journal records, you can improve the efficiency of the sort operation by changing the number and location of the work files used by SORT/MERGE. The number of work files is controlled by the RDM\$BIND_SORT_WORKFILES logical name. The allowable values are 1 through 10 inclusive, with a default value of 2. The location of these work files can be specified with device specifications, using the SORTWORKn logical name (where *n* is a number from 0 to 9). See the OpenVMS documentation set for more information on using SORT/MERGE. See the *Oracle Rdb7 Guide to Database Performance and Tuning* for more information on using these Oracle Rdb logical names.
- Do not use the OpenVMS Alpha High Performance Sort/Merge utility (selected by defining the logical name SORTSHR to SYS\$SHARE:HYPERSORT) when using the RMU Optimize After_Journal command. HYPERSORT does not support several of the interfaces the command uses. In addition, HYPERSORT does not report errors or warnings when it is used with the RMU Optimize After_Journal command.

Make sure that the SORTSHR logical name is not defined to reference HYPERSORT.EXE.

- You can redirect the AIJ rollforward temporary work files and the database recovery (DBR) redo temporary work files to a different disk and directory location than the default (SYS\$DISK) by assigning a different directory to the RDM\$BIND_AIJ_WORK_FILE logical in the LNM\$FILE_DEV name table and a different directory to the RDM\$BIND_DBR_WORK_FILE logical in the LNM\$SYSTEM_TABLE, respectively.
This can be helpful in alleviating I/O bottlenecks that might be occurring in the default location.
- You can optimize an inactive .aij file that results, for example, from backing up and renaming an extensible .aij file. Backing up and renaming an extensible .aij file creates a new active, primary .aij file and makes the previous .aij file inactive. After optimizing the inactive .aij file, you can use the OpenVMS BACKUP command to back up the .oaij file. Note that you cannot optimize an active, primary .aij file.

1.35 RMU Optimize After_Journal Command

- The RMU Optimize After_Journal command can read an .aij file on disk or a backed up .aij file on disk or on tape that is in the Old_File format, and it can write the .oaij file to disk or to tape in either Old_File or New_Tape format.
- If an RMU Optimize After_Journal command is issued from a batch job, tape requests and problems are reported to the tape operator. This occurs because tape requests and problems often require manual intervention, and if the RMU Optimize After_Journal command was issued from a batch job, the only available person might be the operator.
- When the RMU Optimize After_Journal command is issued interactively and a tape request or problem arises, Oracle RMU notifies the person who issued the command through the I/O channel assigned to the logical name SYS\$COMMAND. After being notified of the problem, the user who issued the command can either fix the problem (if the user has access to the tape drive) or contact the tape operator to ask the tape operator to fix the problem. The REQUEST command can be used to notify the tape operator, as follows:

```
$ REQUEST/REPLY/TO=TAPES -  
_$_ "Please Write Enable tape ATOZBG on drive $255$MUA6:"
```

- You should use the density values added in OpenVMS Version 7.2-1 for OpenVMS tape device drivers that accept them because previously supported values may not work as expected. If previously supported values are specified for drivers that support the OpenVMS Version 7.2-1 density values, the older values are translated to the Version 7.2-1 density values if possible. If the value cannot be translated, a warning message is generated, and the specified value is used.

If you use density values added in OpenVMS Version 7.2-1 for tape device drivers that do not support them, the values are translated to acceptable values if possible. If the value cannot be translated, a warning message is generated and the density value is translated to the existing default internal density value (MT\$K_DEFAULT).

One of the following density-related errors is generated if there is a mismatch between the specified density value and the values that the tape device driver accepts:

```
%DBO-E-DENSITY, TAPE_DEVICE:[000000]DATABASE.BCK; does not support  
specified density  
  
%DBO-E-POSITERR, error positioning TAPE_DEVICE:  
  
%DBO-E-BADDENSITY, The specified tape density is invalid for  
this device
```

1.35 RMU Optimize After_Journal Command

- If you want to use an unsupported density value, use the VMS INITIALIZE and MOUNT commands to set the tape density. Do not use the Density qualifier.
- Because data stream names representing the database are generated based on the backup file name specified for the Oracle RMU backup command, you must either use a different backup file name to store the next backup of the database to the Librarian utility or first delete the existing data streams generated from the backup file name before the same backup file name can be reused.

To delete the existing data streams stored in the Librarian utility, you can use a Librarian management utility or the Oracle RMU Librarian/Remove command.

Examples

Example 1

The following command creates an .oaij file named mf_personnel.oaij from the .aij file named mf_personnel.aij:

```
$ RMU/OPTIMIZE/AFTER_JOURNAL MF_PERSONNEL.AIJ MF_PERSONNEL.OAIJ
```

Example 2

The following example uses a density value with compression:

```
RMU/OPTIMIZE/AFTER_JOURNAL /DENSITY=(TK89,COMPACTION)/REWIND -  
/LABEL=(LABEL1,LABEL2) MF_PERSONNEL.AIJ TAPE1:MF_PERSONNEL.OAIJ, TAPE2:
```

1.36 RMU Populate_Cache Command

1.36 RMU Populate_Cache Command

Reads one or more tables and indexes from the database and stores the data rows or index nodes in caches if they exist.

Format

RMU/Populate_Cache root-file-spec

Command Qualifiers

/Index=index-list
/[No]Log
/[No]Only_Cached
/Statistics_Interval=n
/Table=table-list
/Transaction_Type=transaction-mode

Defaults

None
Current DCL verify switch
/Only_Cached
/Statistics_Interval=10
None
/Transaction_Type=Automatic

Description

The RMU Populate_Cache command allows one or more tables and indexes to be read from the database and stored in caches if they exist.

Sorted indexes are read top-down, one index level at a time. Hashed indexes are read by sequentially scanning the storage areas containing the hashed indexes and fetching all nodes and the system record from each database page. Data table rows are read by sequentially scanning the storage areas containing the table and fetching all rows of the relation.

Command Parameters

root-file-spec

Specifies the database root (.rdb) file. The default file type is .rdb.

Command Qualifiers

Index=Index-list

Specifies one or more indexes to fetch. All nodes are fetched from each index. If you list multiple indexes, separate the index names with a comma and enclose the list within parentheses. Wildcard characters asterisk (*) and percent sign (%) are allowed.

1.36 RMU Populate_Cache Command

Log

Nolog

Specifies whether the processing of the command is reported to SYS\$OUTPUT. Specify the Log qualifier to request that information about the operation be displayed, and the Nolog qualifier to prevent it. If you specify neither qualifier, the default is the current setting of the DCL verify switch. (The DCL SET VERIFY command controls the DCL verify switch.)

Only_Cached

Noonly_Cached

Specifies whether table or index content is to be read only if the table or index has an associated row cache. The default is to read data only from objects that have a cache. If the Noonly_Cached qualifier is specified, then all data from the specified tables or indexes is read.

Statistics_Interval=n

Specifies if statistics information is to be periodically displayed during the populate operation. The default for this qualifier is an interval of 10 seconds. If you do not use this qualifier no statistics are displayed.

Table=table-list

Specifies one or more tables to be processed. All rows are fetched from each table. If you list multiple tables, separate the table names with a comma, and enclose the list within parentheses. Wildcard characters asterisk (*) and percent sign (%) are allowed.

Transaction_Type=option

Allows you to specify the transaction mode for the transactions used to perform the analyze operation. Valid options are:

- Automatic
- Read_Only
- Noread_Only

You must specify an option if you use this qualifier.

If you do not specify any form of this qualifier, the Transaction_Type=Automatic qualifier is the default. This qualifier specifies that Oracle RMU is to determine the transaction mode.

The Transaction_Type=Read_Only qualifier specifies the transactions used to perform the analyze operation be set to read-only mode. When you explicitly set the transaction type to read-only, snapshots need not be enabled for all storage areas in the database, but must be enabled for those storage areas that are read. Otherwise, you receive an error and the analyze operation fails.

1.36 RMU Populate_Cache Command

You might select this option if not all storage areas have snapshots enabled and you are analyzing objects that are stored only in storage areas with snapshots enabled. In this case, using the `Transaction_Type=Read_Only` qualifier allows you to perform the analyze operation and impose minimal locking on other users of the database.

The `Transaction_Type=Noread_Only` qualifier specifies that the transactions used to for the analyze operation be set to read/write mode. You might select this option if you want to eradicate the growth of snapshot files that occurs during a read-only transaction and are willing to incur the cost of increased locking that occurs during a read/write transaction.

1.37 RMU Reclaim Command

Allows you to rapidly reclaim deleted dbkeys and locked space from database pages.

Format

RMU/Reclaim root-file-spec

Command Qualifiers

/Area[=storage-area-list]
/[No]Log

Defaults

All storage areas
/NoLog

Description

Applications that specify the database attach attribute `DBKEY SCOPE IS ATTACH` can accumulate locked space and locked dbkeys within the database. If one user is connected to the database in `DBKEY SCOPE IS ATTACH` mode, all users are forced to operate in this mode, even if they are explicitly connected in `TRANSACTION` mode. No dbkeys are reused until the `ATTACH` session disconnects.

The RMU Reclaim command allows database keys of deleted rows to be rapidly reset in one or more storage areas. The RMU Reclaim command reads and updates all pages in a storage area, and, where possible, releases locked lines and locked free space so that they are available for later allocation.

Command Parameters

root-file-spec

Specifies the database that contains locked areas or keys to be reclaimed. The default file extension is `.rdb`.

Command Qualifiers

Area[=storage-area-list]

Lists the storage areas to be reclaimed. The default is all storage areas.

Log

Nolog

Displays a log message as each storage area is reclaimed. The default is `Nolog`.

1.37 RMU Reclaim Command

Usage Notes

- The RMU Reclaim command runs on-line and does not require exclusive access. However, if there are any users connected to the database in DBKEY SCOPE IS ATTACH mode, the RMU/RECLAIM operation has greatly reduced effect. In order to release all possible locked space, there should be no users attached to the database in DBKEY SCOPE IS ATTACH mode.
- To allow database page locked space to be reclaimed, the database session that controls the locked space must be detached from the database. This can be accomplished by having each attached session disconnect and reconnect to the database.

1.38 RMU Recover Command

Completes a database reconstruction by processing past transactions from the after-image journal (.aij) file or optimized after-image journal (.oaij) file against a database restored from a backup file.

Format

RMU/Recover aij-file-name-list

Command Qualifiers

/Active_IO=max-reads
 /Aij_Buffers=integer
 /Areas [= storage-area[,...]]
 /[No]Automatic
 /Encrypt={Value=Name=}[,Algorithm=]
 /Format={Old_File|New_Tape}
 /Just_Corrupt
 /Label=(label-name-list)
 /Librarian[=options]
 /[No]Log
 /[No]Media_Loader
 /[No]Online
 /Order_Aij_Files
 /Output=file-name
 /Prompt={Automatic|Operator|Client}

Defaults

/Active_IO=3
 /Aij_Buffers=20
 All storage areas
 /Automatic
 See description
 /Format=Old_File
 See description
 See description
 None
 Current DCL verify value
 See description
 /Noonline
 See description
 See description
 See description

/Resolve
 /[No]Rewind
 /Root=root-file-name
 /[No]Trace
 /Until=date-time

See description
 /Norewind
 See description
 See Description
 Current time

Description

You can use the RMU Recover command to apply the contents of an .aij file to a restored copy of your database. Oracle RMU rolls forward the transactions in the .aij file into the restored copy of the database.

The RMU Recover command accepts a list of .aij or .oaij file names. Unless you specify the Noautomatic qualifier, the RMU Recover command attempts to automatically complete the recovery operation by applying the journals currently associated with the database in the current journal configuration if

1.38 RMU Recover Command

they are in the recovery sequence. For example, if you specify the following RMU Recover command, Oracle RMU not only recovers AIJ1, but also AIJ2, AIJ3, and so on, for all journals in the recovery sequence:

```
$ RMU/RECOVER AIJ1
```

However, note that this automatic recovery feature means that if you want to specify a termination condition, you must specify the `Until` qualifier. Example 1 demonstrates how to specify a termination condition with the `Until` qualifier.

If you are using extensible journals, you can also use the `RMU Backup After_Journal` command to copy your database's .aij file to tape, and truncate the original .aij file without shutting down your database.

If you have backed up your .aij files (using the `RMU Backup After_Journal` command), these .aij files are no longer part of the current journal configuration and automatic recovery does not take place because Oracle RMU does not know where to find the .aij files. (There is one exception to this rule: if the only .aij file that has been backed up is the first .aij file in the recovery sequence, then automatic recovery occurs. You specify the backed up .aij file on the Oracle RMU command line and Oracle RMU can determine where the remaining on-disk .aij files reside.)

When automatic recover does not, or cannot occur, you must specify the complete list of .aij files on the `RMU Recover` command line to return your database to the desired state.

If your backup files were created using the `Noquiet_Point` qualifier, you must provide the names of all the .aij files in just one command. In addition, you must be careful to apply these .aij files to the database in the order in which they were created. Oracle RMU checks the validity of the journal file entries against your database and applies only appropriate transactions. If none of the transactions apply, you will receive a warning message.

You can access your database for retrieval of data between recovery steps, but you must not perform additional updates if you want to perform more recovery steps.

If a system failure causes a recovery step to abort, you can simply issue the `RMU Recover` command again. Oracle RMU scans the .aij file until it finds the first transaction that has not yet been applied to your restored database. Oracle RMU begins recovery at that point.

1.38 RMU Recover Command

Command Parameters

aij-file-name-list

A list of after-image journal (.aij) files to be applied to the database. You can supply this list using one of the following methods:

- List the .aij files on the command line in the order in which they were created. In other words, the oldest .aij file must be the first in the list.
- Use an asterisk (*) or percent sign (%) to represent the .aij files. The .aij files are processed in the order that they are presented by OpenVMS.
- Append all your .aij files into one file and supply a single .aij file name. You must be certain when you append the files that you append them in the order in which they were created.
- Use an indirect command file. Include an .aij file name on each line of the command file. If the number of .aij files needed for recovery is large, listing each one on the command line can exceed the maximum allowed command-line length. You can avoid this problem by using an indirect command file. See Section 1.3 for more information on indirect command files.

Command Qualifiers

Active_IO=max-reads

Specifies the maximum number of read operations from a backup device that the RMU Recover command attempts simultaneously. This is not the maximum number of read operations in progress; that value is a function of active system I/O operations.

The value of the Active_IO qualifier can range from 1 to 5. The default value is 3. Values larger than 3 can improve performance with some tape drives.

Aij_Buffers=integer

Specifies the number of buffers to be used by the recovery process. The default is 20 buffers. The valid range is 2 to 1,048,576 buffers. If the database root file is available, you can use the RMU Dump After_Journal command with the Option=Statistics qualifier to find a recommended value for this qualifier. See Section 1.20 for details.

Areas[=storage-area[,...]]

Specifies the areas you want to recover. You can specify each storage area by name or by the area's ID number.

1.38 RMU Recover Command

You should use the `Areas` qualifier only if you have inconsistent storage areas to recover. The default for the `Areas` qualifier is all storage areas that must be recovered to make the database consistent.

If the `Areas` qualifier is specified, a recovery operation by area recovers until the storage areas being rolled forward are current with the other storage areas, then recovery stops, regardless of the time specified by the `Until` qualifier.

When the `Areas` qualifier is not specified or the `Areas=*` qualifier is specified, Oracle RMU recovers all the storage areas in the database to the time specified by the `Until` qualifier or to the time of the last committed transaction in the `.aij` file that can be applied. When the `Areas` qualifier is specified without a value, Oracle RMU recovers to the earliest consistent state only those storage areas that are not current with the database root (`.rdb`) file of the database.

The `Areas` qualifier works in the following manner:

- If the `Areas` qualifier is specified without a value, Oracle RMU automatically determines what areas are inconsistent and recovers those areas. If an inconsistent area cannot be recovered because it is at a higher transaction sequence number (TSN) value than the database root file, the entire database is recovered even if the `Areas` qualifier was specified.
See the *Oracle Rdb Guide to Database Maintenance* for information on TSNs.
- If the `Areas` qualifier is omitted or the `Areas` qualifier is specified as `Areas=*`, the entire database (all storage areas) is recovered.
- If the `Areas` qualifier is specified as `Areas=(A1,A2,A3)`, only areas A1, A2, and A3 are recovered until they are consistent. If one of these areas is already consistent, or if an area is at a higher TSN value than the database root file, the entire database is recovered.
- If the `Online` qualifier is specified with the `Areas` qualifier (as in the first three list items) and the end result is that the entire database must be recovered, an error message is generated because you can recover only individual areas by using the `Online` qualifier, not the entire database.

You cannot use the `Areas` qualifier with the `Just_Corrupt` qualifier because the `Areas` qualifier implies recovery for all named areas and pages in those areas. (That is, use of the `Just_Corrupt` qualifier with the `Areas` qualifier is redundant.)

The `Areas` qualifier can be used with indirect file references. See Section 1.3 for more information.

1.38 RMU Recover Command

Automatic

Noautomatic

Specifies whether or not Oracle RMU should attempt automatic recovery of .ajj files. If you specify the Noautomatic qualifier, only the .ajj file or files you list on the Oracle RMU command line are applied. If you specify the Automatic qualifier, Oracle RMU attempts to recover all the .ajj files currently associated with the database.

The Automatic qualifier is the default; Oracle RMU attempts to recover all the .ajj files currently associated with the database unless the .ajj files have been backed up.

See the description section for more information on how automatic recovery works.

Encrypt={Value= | Name=}[,Algorithm=]

The Encrypt qualifier is used to recover the database from an encrypted after image journal backup file.

Specify a key value as a string or, the name of a predefined key. If no algorithm name is specified the default is DESCBC. For details on the Value, Name and Algorithm parameters see `HELP ENCRYPT`.

This feature requires the OpenVMS Encrypt product to be installed and licensed on this system.

This feature only works for a newer format backup file which has been created using the `Format=New_Tape` qualifier. Therefore you have to specify the `Format=New_Tape` qualifier with this command if you also use the Encrypt qualifier.

Format=Old_Rms

Format=New_Tape

Synonymous with the `Format=Old_File` and `Format=New_Tape` qualifiers. See the description of those qualifiers.

Format=Old_File

Format=New_Tape

Specifies whether the backed up or optimized .ajj file was written in the old (disk-optimized) or the new (tape-optimized) format. The `Format=Old_File` qualifier is the default. You must specify the same Format qualifier that was used with the `RMU Backup After_Journal` command or the `RMU Optimize After_Journal` command. If your .ajj file resides on disk, you should use the `Format=Old_File` qualifier.

1.38 RMU Recover Command

If you specified the `Format=Old_File` qualifier when you optimized or backed up the `.aij` file to tape, you must mount the backup media by using the `DCL MOUNT` command before you issue the `RMU Recover` command. Because the `RMU Recover` command will use `RMS` to read the tape, the tape must be mounted as an `OpenVMS` volume (that is, do not specify the `/FOREIGN` qualifier with the `MOUNT` command).

If you specify the `Format=New_Tape` qualifier, you must mount the backup media by using the `DCL MOUNT /FOREIGN` command before you issue the `RMU Recover` command.

Similarly, if you specify `OpenVMS` access (you do not specify the `/FOREIGN` qualifier on the `DCL MOUNT` command) although your `.aij` backup was created using the `Format=New_Tape` qualifier, you will receive an `RMU-F-MOUNTFOR` error.

The following tape qualifiers have meaning only when used in conjunction with the `Format=New_Tape` qualifier:

- Active_IO
- Label
- Rewind

Just_Corrupt

Specifies that only inconsistent pages in the corrupt page table (CPT) and areas marked as inconsistent should be recovered. You can use this qualifier while users are attached to the database.

You can use the `Just_Corrupt` qualifier with the `Until` qualifier to limit the recovery period to a particular point in time.

You cannot use the `Areas` qualifier with the `Just_Corrupt` qualifier because the `Areas` qualifier implies recovery for all named areas and pages in those areas. (That is, use of the `Just_Corrupt` qualifier with the `Areas` qualifier is redundant.)

If you do not specify the `Just_Corrupt` qualifier, all pages are recovered.

Just_Pages

This qualifier is replaced with the `Just_Corrupt` qualifier beginning in Oracle Rdb V7.0. See the description of the `Just_Corrupt` qualifier.

Specifies the 1- to 6-character string with which the volumes of the backup

Label=(label-name-list)

Specifies the 1- to 6-character string with which the volumes of the backup file have been labeled. The `Label` qualifier is applicable only to tape volumes. You must specify one or more label names when you use the `Label` qualifier.

1.38 RMU Recover Command

You can specify a list of tape labels for multiple tapes. If you list multiple tape label names, separate the names with commas, and enclose the list of names within parentheses.

In a normal recovery operation, the Label qualifier you specify with the RMU Recover command should be the same Label qualifier you specified with the RMU Backup After_Journal command to back up your .aij files.

The Label qualifier can be used with indirect file references. See Section 1.3 for more information.

Librarian[=options]

Use the Librarian qualifier to restore files from data archiving software applications that support the Oracle Media Management interface. The file name specified on the command line identifies the stream of data to be retrieved from the Librarian utility. If you supply a device specification or a version number it will be ignored.

Oracle RMU supports retrieval using the Librarian qualifier only for data that has been previously stored by Oracle RMU using the Librarian qualifier.

The Librarian qualifier accepts the following options:

- **Trace_file=file-specification**
The Librarian utility writes trace data to the specified file.
- **Level_Trace=n**
Use this option as a debugging tool to specify the level of trace data written by the Librarian utility. You can use a pre-determined value of 0, 1, or 2, or a higher value defined by the Librarian utility. The pre-determined values are :
 - Level 0 traces all error conditions. This is the default.
 - Level 1 traces the entry and exit from each Librarian function.
 - Level 2 traces the entry and exit from each Librarian function, the value of all function parameters, and the first 32 bytes of each read/write buffer, in hexadecimal.
- **Logical_Names=(logical_name=equivalence-value,...)**
You can use this option to specify a list of process logical names that the Librarian utility can use to specify catalogs or archives where Oracle Rdb backup files are stored, Librarian debug logical names, and so on. See the specific Librarian documentation for the definition of logical names. The list of process logical names is defined by Oracle RMU prior to the start of any Oracle RMU command that accesses the Librarian application.

1.38 RMU Recover Command

The following OpenVMS logical names must be defined for use with a Librarian utility before you execute an Oracle RMU backup or restore operation. Do not use the Logical_Names option provided with the Librarian qualifier to define these logical names.

- **RMU\$LIBRARIAN_PATH**

This logical name must be defined so that the shareable Librarian image can be loaded and called by Oracle RMU backup and restore operations. The translation must include the file type (for example, .exe), and must not include a version number. The shareable Librarian image must be an installed (known) image. See the Librarian utility documentation for the name and location of this image and how it should be installed.

- **RMU\$DEBUG_SBT**

This logical name is not required. If it is defined, Oracle RMU will display debug tracing information messages from modules that make calls to the Librarian shareable image.

You cannot use device specific qualifiers such as Rewind, Density, or Label with the Librarian qualifier because the Librarian utility handles the storage media, not Oracle RMU.

Log

Nolog

Specifies that the recovery activity be logged. The default is the setting of the DCL VERIFY flag, which is controlled by the DCL SET VERIFY command. When recovery activity is logged, the output from the Log qualifier provides the number of transactions committed, rolled back, and ignored during the recovery process. You can specify the Trace qualifier with the Log qualifier.

Media Loader

Nomedia Loader

Use the Media Loader qualifier to specify that the tape device from which the .aij file is being read has a loader or stacker. Use the Nomedia Loader qualifier to specify that the tape device does not have a loader or stacker.

By default, if a tape device has a loader or stacker, Oracle RMU should recognize this fact. However, occasionally Oracle RMU does not recognize that a tape device has a loader or stacker. Therefore, when the first tape has been read, Oracle RMU issues a request to the operator for the next tape, instead of requesting the next tape from the loader or stacker. Similarly, sometimes Oracle RMU behaves as though a tape device has a loader or stacker when actually it does not.

1.38 RMU Recover Command

If you find that Oracle RMU is not recognizing that your tape device has a loader or stacker, specify the `Media_Loader` qualifier. If you find that Oracle RMU expects a loader or stacker when it should not, specify the `Nomedia_Loader` qualifier.

Online

Noonline

Specifies that the recover operation be performed while other users are attached to the database. The `Online` qualifier can only be used with the `Area` or `Just_Corrupt` qualifier. The areas or pages to be recovered are locked for exclusive access, so the operation is not compatible with other uses of the data in the areas or on the pages specified.

The default is the `Noonline` qualifier.

Order_Aij_Files

Specifies that the input after-image journal files are to be processed in ascending order by sequence number. The `.aij` files are each opened, the first block is read to determine the sequence number, and the files are closed prior to the sequence number sorting operation. The `Order_Aij_Files` can be especially useful if you use wildcards to specify `.aij` files.

Output=file-name

Redirects the log and trace output (selected with the `Log` and `Trace` qualifiers) to the named file. If this qualifier is not specified, the output generated by the `Log` and `Trace` qualifiers, which can be voluminous, is displayed on your terminal.

Prompt=Automatic

Prompt=Operator

Prompt=Client

Specifies where server prompts are to be sent. When you specify `Prompt=Automatic`, prompts are sent to the standard input device, and when you specify `Prompt=Operator`, prompts are sent to the server console. When you specify `Prompt=Client`, prompts are sent to the client system.

Resolve

Recovers a corrupted database and resolves an unresolved transaction by completing the transaction.

See the `RMU Recover Resolve` command (Section 1.39) for a description of the options available with the `Resolve` qualifier.

1.38 RMU Recover Command

Rewind

Norewind

Specifies that the tape that contains the backup file be rewound before processing begins. The tape is searched for the backup file starting at the beginning-of-tape (BOT). The Norewind qualifier is the default and causes the backup file to be searched starting at the current tape position.

The Rewind and Norewind qualifiers are applicable only to tape devices. Oracle RMU returns an error message if these qualifiers are used and the target device is not a tape device.

Root=root-file-name

Specifies the name of the database to which the journal should be applied. The Root qualifier allows you to specify a copy of a database instead of the original whose file specification is in the .aij file. Use the Root qualifier to specify the new location of your restored database root (.rdb) file.

Specifying this qualifier lets you roll forward a database copy (possibly residing on a different disk) by following these steps:

1. Use the RMU Backup command to make a backup copy of the database:

```
$ RMU/BACKUP MF_PERSONNEL.RDB MF_PERS_FULL_BU.RBF
```

This command writes a backup file of the database mf_personnel to the file mf_pers_full_bu.rbf.

2. Use the RMU Restore command with the Root and Directory qualifiers, stating the file specifications of the database root and storage area files in the database copy.

```
$ RMU/RESTORE/ROOT=DB3:[USER]MF_PERSONNEL/DIRECTORY=DB3:[USER] -  
_ $ MF_PERS_FULL_BU
```

This command restores the database on disk DB3: in the directory [USER]. Default file names and file extensions are used.

3. If the database uses after-image journaling, you can use the RMU Recover command to roll forward the copy.

```
$ RMU/RECOVER DBJNL.AIJ/ROOT=DB3:[USER]MF_PERSONNEL.RDB
```

Thus, transactions processed and journaled since the backup operation are recovered on the copy on the DB3: disk.

Correct operation of this procedure requires that there are no write transactions for the restored copy between the restore and recover steps.

1.38 RMU Recover Command

If you do not specify the Root qualifier, Oracle RMU examines the .ajj file to determine the exact name of the database root (.rdb) file to which the journaled transactions will be applied. This name, which was stored in the .ajj file, is the full file specification that your .rdb file had when after-image journaling was enabled.

The journal file for a single-file database does not include the file name for the database; to recover a single-file database, you must specify the location of the database to be recovered by using the Root qualifier.

Trace

Notrace

Specifies that the recovery activity be logged. The default is the setting of the DCL VERIFY flag, which is controlled by the DCL SET VERIFY command. When recovery activity is logged, the output from the Trace qualifier identifies transactions in the .ajj file by TSN and describes what Oracle RMU did with each transaction during the recovery process. You can specify the Log qualifier with the Trace qualifier.

Until=date-time

Use the Until qualifier to limit the recovery to those transactions in the journal file bearing a starting timestamp no later than the specified time. For example, suppose your database fails today, but you have reason to believe that something started to go wrong at noon yesterday. You might decide that you only want to restore the database to the state it was in as of noon yesterday. You could use the Until qualifier to specify that you only want to recover those transactions that have a timestamp of noon yesterday or earlier.

If you do not specify the Until qualifier, all committed transactions in the .ajj file will be applied to your database. If you specify the Until qualifier, but do not specify a date-time, the current time is the default.

If the Until qualifier is specified with a recover-by-area operation, the operation terminates when either the specified time is reached in the transaction sequence or the specified storage areas become consistent with the other storage areas; whichever condition occurs first.

1.38 RMU Recover Command

Usage Notes

- To use the RMU Recover command for a database, you must have the `RMU$RESTORE` privilege in the root file access control list (ACL) for the database or the OpenVMS `SYSPRV` or `BYPASS` privilege.
- You can use the `RMU Backup After_Journal` command to copy an extensible `.ajj` file to tape and truncate the original `.ajj` file without shutting down your database.
- Transactions are applied to the restored copy of your database in the order indicated by their commit sequence number and the commit record in the `.ajj` file; timestamps are not used for this purpose. Therefore, you need not be concerned over time changes made to the system (for example, resetting the time for United States daylight saving time) or inconsistencies in the system time on different nodes in a cluster. The only occasion when timestamps are considered in the application of `.ajj` files is when you specify the `Until` qualifier. In this case, the timestamp is used only as the point at which to stop the recovery, not as a means to serialize the order in which transactions are applied. See the description of the `Until` qualifier for more information.
- You can redirect the AIJ rollforward temporary work files and the database recovery (DBR) redo temporary work files to a different disk and directory location than the default (`SYS$DISK`) by assigning a different directory to the `RDM$BIND_AIJ_WORK_FILE` logical in the `LNМ$FILE_DEV` name table and a different directory to the `RDM$BIND_DBR_WORK_FILE` logical in the `LNМ$SYSTEM_TABLE`, respectively.

This can be helpful in alleviating I/O bottlenecks that might be occurring in the default location.

- In a normal recovery operation, the `Format` and `Label` qualifiers you specify with the `RMU Recover` command should be the same `Format` and `Label` qualifiers you specified with the `RMU Backup After_Journal` command to back up your `.ajj` files or with the `RMU Optimize After_Journal` command to optimize your `.ajj` files.

For more information on the type of access to specify when mounting tapes, see the description of the `Format=Old_File` and `Format=New_Tape` qualifiers in the `Command Qualifiers` section.

1.38 RMU Recover Command

- The following restrictions apply to using optimized .aij files with recovery operations:
 - Optimized .aij files cannot be used as part of by-area recovery operations (recovery operations that use the RMU Recover command with the Area qualifier).
 - Optimized .aij files cannot be used as part of by-page recovery operations (recovery operations that use the RMU Recover command with the Just_Corrupt qualifier).
 - Optimized .aij files cannot be specified for an RMU Recover command that includes the Until qualifier. The optimized .aij file does not retain enough of the information from the original .aij file for such an operation.
 - Optimized .aij files cannot be used with a recovery operation if the database has been modified since the .aij file was optimized.

The workaround for these restrictions against using optimized .aij files in recovery operations is to use the original, unoptimized .aij file in the recovery operation instead.

- You can read your database between recovery steps, but you must not perform additional updates if you want to perform more recovery steps.
- If a system failure causes a recovery step to abort, you can simply issue the RMU Recover command again. Oracle RMU scans the .aij file until it finds the first transaction that has not yet been applied to your restored database. Oracle RMU begins recovery at that point.
- You can use the RMU Recover command to apply the contents of an .aij file to a restored copy of your database. Oracle RMU will roll forward the transactions in the .aij file into the restored copy of the database. You can use this feature to maintain an up-to-date copy of your database for fast recovery after a failure. To do this, use the RMU Recover command to periodically apply your .aij files to a separate copy of the database.

When you employ this procedure for fast recovery, you must be absolutely certain that no one will execute an update transaction on the database copy. Should someone execute an update transaction, it might result in the inability to apply the .aij files correctly.
- See the *Oracle Rdb Guide to Database Maintenance* for information on the steps Oracle RMU follows in tape label checking.

1.38 RMU Recover Command

- When you use an optimized after-image journal for recovery, the optimal number of buffers specified with the `Aij_Buffers` qualifier depends on the number of active storage areas being recovered. For those journals optimized with `Recover_Method=Sequential`, a buffer count of 250 to 500 is usually sufficient.

When you use journals optimized with `Recover_Method=Scatter`, reasonable performance can usually be attained with a buffer count of about five times the number of active storage areas being recovered (with a minimum of about 250 to 500 buffers).

- The number of asynchronous prefetch (APF) buffers is also a performance factor during recovery. For recovery operations of optimized after-image journals, the RMU Recover command sets the number of APF buffers (also known as the APF depth) based on the values of the process quotas `ASTLM`, `BYTLM`, and the specified `AIJ_Buffers` value. The APF depth is set to the maximum of:
 - 50% of the `ASTLM` process quota
 - 50% of the `DIOLM` process quota
 - 25% of the specified `AIJ_Buffers` value

The accounts and processes that perform RMU Recover operations should be reviewed to ensure that various quotas are set to ensure high levels of I/O performance. The following table lists suggested quota values for recovery performance.

Quota	Setting
DIOLM	Equal to or greater than half of the count of database buffers specified by the <code>AIJ_Buffers</code> qualifier. Minimum of 250.
BIOLM	Equal to or greater than the setting of <code>DIOLM</code> .
ASTLM	Equal to or greater than 50 more than the setting of <code>DIOLM</code> .
BYTLM	Equal to or greater than 512 times the database buffer size times one half the value of database buffers specified by the <code>AIJ_Buffers</code> qualifier. Based on a 12-block buffer size and the desire to have 100 asynchronous I/O requests outstanding (either reading or writing), the minimum suggested value is 614,400 for a buffer count of 200.

1.38 RMU Recover Command

Quota	Setting
WSQUOTA WSEXTENT	Large enough to avoid excessive page faulting.
FILLM	50 more than the count of database storage areas and snapshot storage areas.

Examples

Example 1

In the following example, the RMU Recover command requests recovery from the .aij file personnel.aij located on PR\$DISK in the SMITH directory. It specifies that recovery should continue until 1:30 P.M. on May 7, 1996. Because the Trace qualifier is specified, the RMU Recover command displays detailed information about the recovery operation to SYS\$OUTPUT.

```
$ RMU/RECOVER/UNTIL="07-MAY-1996 13:30"/TRACE PR$DISK:[SMITH]PERSONNEL
%RMU-I-LOGRECDB, recovering database file DISK1:[DB.70]MF_PERSONNEL.RDB;1
%RMU-I-LOGRECSTAT, transaction with TSN 0:256 committed
%RMU-I-AIJONEDONE, AIJ file sequence 0 roll-forward operations completed
%RMU-I-AIJAUTOREC, starting automatic after-image journal recovery
%RMU-I-AIJONEDONE, AIJ file sequence 1 roll-forward operations completed
%RMU-W-NOTRANAPP, no transactions in this journal were applied
%RMU-I-AIJALLDONE, after-image journal roll-forward operations completed
%RMU-I-AIJSUCCES, database recovery completed successfully
%RMU-I-AIJFNLSEQ, to start another AIJ file recovery, the sequence number
needed will be 1
```

1.38 RMU Recover Command

Example 2

The following example shows how to use .aij files to recover a database:

```
SQL> CREATE DATABASE FILENAME DISK1:[SAMPLE]TEST_DB
cont> RESERVE 5 JOURNALS;
SQL> --
SQL> -- Use the DISCONNECT ALL statement to detach from the database,
SQL> -- then issue the ALTER DATABASE statement that automatically
SQL> -- invokes the specified database.
SQL> --
SQL> DISCONNECT ALL;
SQL> --
SQL> -- Create after-image journaling. The .aij files are given the
SQL> -- names aij_one.aij and aij_two.aij (and are placed on a disk
SQL> -- other than the disk holding the .rdb and .snp files):
SQL> --
SQL> ALTER DATABASE FILENAME DISK1:[SAMPLE]TEST_DB
cont> JOURNAL IS ENABLED
cont>   ADD JOURNAL AIJ_ONE
cont>     FILENAME 'USER$DISK:[CORP]AIJ_ONE'
cont>     BACKUP FILENAME 'USER$DISK2:[CORP]AIJ_ONE'
cont>   ADD JOURNAL AIJ_TWO
cont>     FILENAME 'USER$DISK3:[CORP]AIJ_TWO'
cont>     BACKUP FILENAME 'USER$DISK4:[CORP]AIJ_TWO';
SQL> EXIT
$ !
$ ! Using the RMU Backup command, make a backup copy of the database.
$ ! This command ensures that you have a copy of the
$ ! database at a known time, in a known state.
$ !
$ RMU/BACKUP DISK1:[SAMPLE]TEST_DB USER2:[BACKUPS]TEST_BACKUP.RBF
$ !
$ ! Now you can use SQL with after-image journaling enabled.
$ !
$ SQL
SQL> --
SQL> -- Attach to the database and perform some data definition
SQL> -- and storage.
SQL> --
SQL> ATTACH 'FILENAME DISK1:[SAMPLE]TEST_DB';
SQL> CREATE TABLE TABLE1 (NEW_COLUMN CHAR(10));
SQL> INSERT INTO TABLE1 (NEW_COLUMN) VALUES ('data');
SQL> COMMIT;
SQL> EXIT
$ !
$ ! Imagine that a disk failure occurred here. In such a situation,
$ ! the current database is inaccessible. You need a prior copy
$ ! of the database to roll forward all the transactions in the
$ ! .aij file.
$ !
```

1.38 RMU Recover Command

```
$ !
$ ! You know that the backup file of the database is
$ ! uncorrupted. Use the RMU Restore command to restore and recover
$ ! the database. You do not have to issue the RMU Recover command
$ ! because the RMU Restore command will automatically recover the
$ ! database.
$ !
$ RMU/RESTORE/NOCDI_INTEGRATE/DIR=DDV21:[TEST] -
_$ USER2:[BACKUPS]TEST_BACKUP.RBF
%RMU-I-AIJRSTAVL, 2 after-image journals available for use
%RMU-I-AIJRSTMOD, 1 after-image journal marked as "modified"
%RMU-I-AIJISON, after-image journaling has been enabled
%RMU-W-DOFULLBCK, full database backup should be done to ensure
future recovery
%RMU-I-LOGRECD, recovering database file DDV21:[TEST]TEST_DB.RDB;1
%RMU-I-AIJAUTOREC, starting automatic after-image journal recovery
%RMU-I-AIJONEDONE, AIJ file sequence 0 roll-forward operations completed
%RMU-I-AIJONEDONE, AIJ file sequence 1 roll-forward operations completed
%RMU-W-NOTRANAPP, no transactions in this journal were applied
%RMU-I-AIJALLDONE, after-image journal roll-forward operations completed
%RMU-I-AIJSUCCE, database recovery completed successfully
%RMU-I-AIJFNLSEQ, to start another AIJ file recovery, the sequence
number needed will be 1
```

Example 3

The following example demonstrates how the recovery operation works when there are .aij backup files to be applied. First you must restore the database by using the RMU Restore command with the Norecovery qualifier, then apply the backed up .aij file by using the RMU Recover command. Oracle RMU will complete the recovery with the .aij files that were current when the restore operation was invoked. This example assumes that three .aij files have been added to the mf_personnel database prior to the first shown backup operation and that journaling is enabled.

```
$ ! Create a backup file of the complete and full database.
$ !
$ RMU/BACKUP MF_PERSONNEL DISK1:[BACKUPS]MF_PERSONNEL_BCK.RBF
$ !
$ ! Updates are made to the SALARY_HISTORY and DEPARTMENTS tables.
$ !
$ SQL
SQL> ATTACH 'FILENAME MF_PERSONNEL';
SQL> UPDATE SALARY_HISTORY
cont> SET SALARY_END='20-JUL-1993 00:00:00.00'
cont> WHERE SALARY_START='14-JAN-1983 00:00:00'
cont> AND EMPLOYEE_ID='00164';
```

1.38 RMU Recover Command

```
SQL> INSERT INTO DEPARTMENTS
cont> (DEPARTMENT_CODE, DEPARTMENT_NAME,
cont>  MANAGER_ID,BUDGET_PROJECTED, BUDGET_ACTUAL)
cont> VALUES ('WLNS', 'WELLNESS CENTER', '00188',0,0);
SQL> COMMIT;
SQL> DISCONNECT DEFAULT;
SQL> EXIT
$ !
$ ! Create a backup file of the .aij files.
$ !
$ RMU/BACKUP/AFTER_JOURNAL MF_PERSONNEL DISK2:[BACKUP]MF_PERS_AIJBCK
$ !
$ ! An additional update is made to the DEPARTMENTS table.
$ !
$ SQL
SQL> ATTACH 'FILENAME MF_PERSONNEL';
SQL> INSERT INTO DEPARTMENTS
cont> (DEPARTMENT_CODE, DEPARTMENT_NAME, MANAGER_ID,BUDGET_PROJECTED,
cont>  BUDGET_ACTUAL)
cont> VALUES ('fac1', 'FACILITIES', '00190',0,0);
SQL> COMMIT;
SQL> DISCONNECT DEFAULT;
SQL> EXIT;
$
$ ! Assume the disk holding the SALARY_HISTORY and DEPARTMENTS
$ ! storage areas is lost. Restore only those areas. Specify
$ ! the Norecovery qualifier since you will need to apply the
$ ! .aij backup file.
$
$ RMU/RESTORE/AREA DISK1:[BACKUPS]MF_PERSONNEL_BCK.RBF -
_$ SALARY_HISTORY, DEPARTMENTS/NORECOVER
$ !
$ ! Now recover the database. Although you only specify the .aij
$ ! backup file, Oracle RMU will automatically continue the
$ ! recovery with the current journals in the recovery sequence after
$ ! the backed up .aij files have been applied.
$ !
$ RMU/RECOVER/LOG DISK2:[BACKUP]MF_PERS_AIJBCK
%RMU-I-AIJBADAREA, inconsistent storage area DISK3:[STO_AREA]
DEPARTMENTS.RDA;1 needs AIJ sequence number 0
%RMU-I-AIJBADAREA, inconsistent storage area
DISK3:[STO_AREA]SALARY_HISTORY.RDA;1 needs AIJ sequence number 0
%RMU-I-LOGRECD, recovering database file
DISK3:[DATABASE]MF_PERSONNEL.RDB;1
%RMU-I-LOGOPNAIJ, opened journal file
DISK2:[BACKUP]MF_PERS_AIJBCK.AIJ;1
```

1.38 RMU Recover Command

```
%RMU-I-AIJONEDONE, AIJ file sequence 0 roll-forward operations
  completed
%RMU-I-LOGRECOVR, 3 transactions committed
%RMU-I-LOGRECOVR, 0 transactions rolled back
%RMU-I-LOGRECOVR, 0 transactions ignored
%RMU-I-AIJNOACTIVE, there are no active transactions
%RMU-I-AIJSUCCES, database recovery completed successfully
%RMU-I-AIJNXTSEQ, to continue this AIJ file recovery, the sequence
  number needed will be 1
%RMU-I-AIJAUTOREC, starting automatic after-image journal recovery
%RMU-I-LOGOPNAIJ, opened journal file DISK4:[CORP]AIJ_TWO.AIJ;1
%RMU-I-AIJONEDONE, AIJ file sequence 1 roll-forward operations
  completed
%RMU-I-LOGRECOVR, 2 transactions committed
%RMU-I-LOGRECOVR, 0 transactions rolled back
%RMU-I-LOGRECOVR, 0 transactions ignored
%RMU-I-AIJNOACTIVE, there are no active transactions
%RMU-I-AIJSUCCES, database recovery completed successfully
%RMU-I-AIJNXTSEQ, to continue this AIJ file recovery, the sequence
  number needed will be 2
%RMU-I-AIJALLDONE, after-image journal roll-forward operations
  completed
%RMU-I-LOGSUMMARY, total 5 transactions committed
%RMU-I-LOGSUMMARY, total 0 transactions rolled back
%RMU-I-LOGSUMMARY, total 0 transactions ignored
%RMU-I-AIJSUCCES, database recovery completed successfully
%RMU-I-AIJGOODAREA, storage area DISK3:[STO_AREA]DEPARTMENTS.RDA;1
  is now consistent
%RMU-I-AIJGOODAREA, storage area DISK3:[STO_AREA]SALARY_HISTORY.RDA;1
  is now consistent
%RMU-I-AIJFNLSEQ, to start another AIJ file recovery, the sequence
  number needed will be 2
$ !
$ ! Database is restored and recovered and ready to use.
$ !
```

Example 4

The following example demonstrates how to recover all the known inconsistent pages in a database. Assume the RMU Show Corrupt_Pages command reveals that page 60 in the EMPIDS_LOW storage area is inconsistent and pages 11 and 123 in the EMPIDS_MID storage area is inconsistent. The RMU Recover command is issued to recover on line all pages logged inconsistent in the corrupt page table (CPT). After the recovery operation, the CPT will be empty.

1.38 RMU Recover Command

```
$ RMU/RECOVER/JUST_CORRUPT/ONLINE/LOG MF_PERSONNEL.AIJ
%RMU-I-AIJBADPAGE, inconsistent page 11 from storage area
  DISK1:[TEST5]EMPIDS_OVER.RDA;1 needs AIJ sequence number 0
%RMU-I-AIJBADPAGE, inconsistent page 60 from storage area
  DISK1:[TEST5]EMPIDS_LOW.RDA;1 needs AIJ sequence number 0
%RMU-I-AIJBADPAGE, inconsistent page 123 from storage area
  DISK1:[TEST5]EMPIDS_OVER.RDA;1 needs AIJ sequence number 0
%RMU-I-LOGRECDB, recovering database file
  DISK2:[TEST5]MF_PERSONNEL.RDB;1
%RMU-I-LOGOPNAIJ, opened journal file DISK3:[TEST5]MF_PERSONNEL.AIJ;1
%RMU-I-AIJNEDONE, AIJ file sequence 0 roll-forward operations
  completed
%RMU-I-LOGRECOVR, 1 transaction committed
%RMU-I-LOGRECOVR, 0 transactions rolled back
%RMU-I-LOGRECOVR, 0 transactions ignored
%RMU-I-AIJNOACTIVE, there are no active transactions
%RMU-I-AIJSUCCE, database recovery completed successfully
%RMU-I-AIJALDONE, after-image journal roll-forward operations
  completed
%RMU-I-LOGSUMMARY, total 1 transaction committed
%RMU-I-LOGSUMMARY, total 0 transactions rolled back
%RMU-I-LOGSUMMARY, total 0 transactions ignored
%RMU-I-AIJSUCCE, database recovery completed successfully
%RMU-I-AIJGOODPAGE, page 11 from storage area
  DISK1:[TEST5]EMPIDS_OVER.RDA;1 is now consistent
%RMU-I-AIJGOODPAGE, page 60 from storage area
  DISK1:[TEST5]EMPIDS_LOW.RDA;1 is now consistent
%RMU-I-AIJGOODPAGE, page 123 from storage area
  DISK1:[TEST5]EMPIDS_OVER.RDA;1 is now consistent
%RMU-I-AIJFNLSEQ, to start another AIJ file recovery, the sequence
  number needed will be 0
```

1.39 RMU Recover Resolve Command

1.39 RMU Recover Resolve Command

Recovers a corrupted database and resolves an unresolved distributed transaction by completing the transaction.

See the *Oracle Rdb7 Guide to Distributed Transactions* for complete information on unresolved transactions and for information on the transactions managers (DECdtm and Encina) supported by Oracle Rdb.

Format

RMU/Recover/Resolve ajj-file-name

Command Qualifiers

/Active_IO=max-reads
/Aij_Buffers=integer
/Areas[=storage-area[,...]]
/[No]Confirm
/Format={Old_File|New_Tape}
/Label=(label-name-list)
/[No]Log
/[No]Media_Loader
/[No]Online
/[No]Rewind
/Root=root-file-name
/State=option
/[No]Trace
/Until=date-time

Defaults

See the RMU/Recover command
See the RMU/Recover command
See the RMU/Recover command
See description
See the RMU/Recover command
See the RMU/Recover command
See the RMU/Recover command
See the RMU/Recover command
See the RMU/Recover command
See the RMU/Recover command
See the RMU/Recover command
See description
See the RMU/Recover command
See the RMU/Recover command

Description

Use the RMU Recover Resolve command to commit or abort any unresolved distributed transactions in the after-image journal (.ajj) file. You must complete the unresolved transactions to the same state (COMMIT or ABORT) in every .ajj file affected by the unresolved transactions.

The RMU Recover Resolve command performs the following tasks:

- Displays identification information for an unresolved transaction.
- Prompts you for the state to which you want the unresolved transaction resolved (if you did not specify the State qualifier on the command line). If you are using DECdtm to manage the transaction, you can specify COMMIT, ABORT, or IGNORE. If you are using an XA transaction, you can specify COMMIT or ABORT.

1.39 RMU Recover Resolve Command

- Prompts for confirmation of the state you specified
- Commits, aborts, or ignores the unresolved transaction
- Continues until it displays information for all unresolved transactions

Command Parameters

aij-file-name

The name of the file containing the after-image journal. This cannot be an optimized after-image journal (.oaij) file. The default file extension is .aij.

Command Qualifiers

Confirm

Noconfirm

Prompts you for confirmation of each transaction state you alter. The default for interactive processing is Confirm.

Specify the Noconfirm qualifier to suppress this prompt. The default for batch processing is Noconfirm.

State=option

Specifies the state to which all unresolved transactions will be resolved.

If you are using DECdtm to manage your distributed transaction, options for the State qualifier are:

- Commit—Commits all unresolved transactions.
- Abort— Aborts all unresolved transactions.
- Ignore—Does not resolve any transactions.

If you are using Encina to manage your distributed transaction, options for the State qualifier are:

- Commit—Commits all unresolved transactions.
- Abort— Aborts all unresolved transactions.

If you do not specify the State qualifier, Oracle RMU prompts you to enter an action, for *each* unresolved transaction in that .aij file. If DECdtm is managing your transaction and you enter Ignore, Oracle RMU—instead of resolving the transaction—attempts to contact the coordinator to resolve the transaction. The transaction remains unresolved until the coordinator becomes available again and instructs the transaction to complete or until you manually complete the transaction by using the RMU Recover Resolve command again. For more

1.39 RMU Recover Resolve Command

information about the activities of the coordinator, see the *Oracle Rdb7 Guide to Distributed Transactions*.

Because a coordinator is not involved with transactions managed by Encina, the Ignore option is not valid for XA transactions.

Usage Notes

- To use the RMU Recover Resolve command for a database, you must have the RMU\$RESTORE privilege in the root file for the database or the OpenVMS SYSPRV or BYPASS privilege.
- If you have restored the database by using the New qualifier and have not deleted the corrupted database, use the Root qualifier to override the original file specification for the database root file.
- After it rolls forward from the .aij file specified on the command line, Oracle RMU prompts you for the name of the next .aij file. If there are more .aij files to roll forward, enter the file name, including the version number for that .aij file. If there are no other .aij files, press the Return key. For more information about rolling forward and determining transaction sequence numbers for .aij files, see the *Oracle Rdb Guide to Database Maintenance*.
- Note the following points regarding using Oracle Rdb with the Encina transaction manager:
 - Only databases that were created under Oracle Rdb V7.0 or higher, or converted to V70 or higher, can participate in XA transactions.
 - To start a distributed transaction, you must have the DISTRIBTRAN database privilege for all databases involved in the transaction.
 - Oracle Rdb supports only explicit distributed transactions with Encina. This means that your application must explicitly call the Encina routines to start and end the transactions.

Examples

Example 1

The following command recovers the mf_personnel database and rolls the database forward from the old .aij file to resolve the unresolved distributed transactions. Because the State qualifier is not specified, Oracle RMU will prompt the user for a state for each unresolved transaction.

```
$ RMU RECOVER/RESOLVE MF_PERSONNEL.AIJ;1
```

1.39 RMU Recover Resolve Command

Example 2

This example specifies that all unresolved transactions in the `mf_personnel.ajj` file be committed.

```
$ RMU/RECOVER/RESOLVE/STATE=COMMIT MF_PERSONNEL.AJJ
```

For more examples of the RMU Recover Resolve command, see the *Oracle Rdb7 Guide to Distributed Transactions*.

1.40 RMU Repair Command

1.40 RMU Repair Command

Corrects several types of database problems. You can use the RMU Repair command to:

- Repair all types of space area management (SPAM) page corruptions by reconstructing the SPAM pages in one or more storage areas.
- Repair all area bit map (ABM) page format errors.
- Repair all page tail errors to the satisfaction of the RMU Verify operation by making sure that every database page is in a logical area and contains the appropriate information for that logical area.
- Correct some performance problems that might otherwise have to be corrected by exporting and importing the database.
- Set damaged or missing segmented string (LIST OF BYTE VARYING) areas that are stored in write-once areas to null.

The repair operation cannot correct corrupted user data, or corrupted indexes; use other commands such as the RMU Restore, the RMU Recover, the SQL IMPORT, or the RMU Load command and delete the affected structures to correct these problems.

Note

Use of the `Abm` or the `Initialize=Tsns` qualifier disables after-image journaling. After issuing an RMU Repair command with these qualifiers, back up the database and reenables journaling manually.

Format

Command Qualifiers

`/[No]Abm`
`/[No]All_Segments`
`/Areas [= {storage-area-list or *}]`
`/Checksum`
`/[No]Initialize=initialize-options`
`/[No]Spams`
`/Tables [=table-list]`
`/Worm_Segments`

Defaults

`/Noabm`
All segments
See description
See description
`/Noinitialize`
See description
All nonsystem tables
None

1.40 RMU Repair Command

Description

Because RMU Repair cannot correct every type of corruption, or guarantee improved performance, Oracle Corporation recommends that you do not use the RMU Repair command unless you have a backup copy or exported copy of your database. You can return to this backup copy of the database if your repair efforts are ineffective.

The RMU Repair command operates off line and not in the context of a transaction, so no records are written to the database's .aij file by RMU Repair, and the repaired database cannot be rolled forward with the RMU Recover command. Oracle Corporation recommends that you make a backup copy of the database after using the RMU Repair command; the repair operation issues a message to this effect. Oracle RMU also issues a warning when you use this command on a database with after-image journaling enabled.

Command Parameters

root-file-spec

A file specification for the database root file for which you want to repair corruption or improve performance.

Command Qualifiers

Abm

Noabm

Causes the reconstruction of the logical area bit map (ABM) pages for areas specified with the Areas qualifier. After-image journaling is disabled when you specify the Abm qualifier. You must explicitly enable after-image journaling after the RMU Repair command completes if you want journaling enabled.

The NoAbm qualifier specifies that ABM pages are not to be reconstructed; this is the default.

All_Segments

Noall_Segments

The All_Segments qualifier specifies that RMU Repair should retrieve all segments of a segmented string; the Noall_Segments qualifier specifies that RMU Repair should only retrieve the first segment of a segmented string.

Specify the Noall_Segments qualifier if you know that the list storage map for any segmented strings stored on the specified areas might have contained multiple areas. For example, if the storage map was created using the following SQL command, Oracle Rdb would store all the segmented strings on AREA1 until AREA1 became full. If AREA1 became full, Oracle Rdb would

1.40 RMU Repair Command

continue to write the rest of the segments into AREA2. Suppose AREA2 becomes corrupt. In this case, retrieving the first segment from AREA1 is not sufficient; all segments must be retrieved to determine if part of the segmented string is missing.

```
CREATE STORAGE MAP FOR LIST STORE IN (AREA1, AREA2) FOR (TABLE1)
  IN RDB$SYSTEM;
```

Specifying the Areas qualifier and the All_Segments qualifier is unnecessary and redundant because specifying the All_Segments qualifier causes RMU Repair to check all storage areas regardless of where the segmented string was stored initially.

Areas[={storage-area-list or *}]

Specifies the storage areas in the database you want to repair. You can specify storage areas by name or by the area's ID number.

By default, all the storage areas in the database are repaired. If you specify more than one storage area, separate the storage area names or ID numbers in the storage-area-list with a comma, and enclose the list within parentheses.

Checksum

Reads every page in the database storage areas to verify that the checksum on each page is correct. If the checksum on the page is incorrect, it is replaced with the correct checksum.

Use the Areas qualifier to specify which storage areas RMU Repair should check. If you do not specify the Areas qualifier, all pages in all storage areas are checked and updated (if incorrect).

This qualifier can be used whether or not users are attached to the database.

This qualifier is not valid for use with any other qualifiers except the Areas qualifier.

Initialize=initialize-options

Noinitialize

Allows you to specify initialization options. If more than one option is specified, separate the options with a comma, and enclose the list of options within parentheses.

The following options are available for the Initialize qualifier:

- Free_Pages

1.40 RMU Repair Command

The `Initialize=Free_Pages` qualifier initializes database pages that do not contain data in the selected storage areas (that have a uniform page format). You can use the `Initialize=Free_Pages` qualifier to correct `BADPTLARE` errors found by the `RMU Verify` command and also to free pages from a table that has many deleted rows. If you specify the default, the `Noinitialize` qualifier, no database pages are initialized.

Frequently, you will receive one or more `RMU-W-ABMBITERR` error messages after you issue the `RMU Repair` command with the `Initialize=Free_Pages` qualifier. This occurs because the initialization of pages can create new ABM errors. Correct these errors by issuing the `RMU Repair` command with the `Abm` qualifier. (However, note that you cannot specify the `Initialize=Free_Pages` qualifier and the `Abm` qualifier on the same command line.) If you ignore the `RMU-W-ABMBITERR` error messages, extra I/O operations will be performed (one for each `RMU-W-ABMBITERR` error you received) when a database query causes a sequential scan of an entire table.

If a table residing in a storage area that has a uniform page format is frequently accessed sequentially, the cost of the sequential access is determined by the number of allocated pages. If the maximum size allocated for the table is much larger than the table's average size, the cost of the sequential access can be excessive. By using the `RMU Repair` command with the `Initialize=Free_Pages` qualifier, you can purge the allocated but unused database pages from the table. In some cases, there may be a decrease in performance when you insert new data into the table after using this option. As with all `Repair` options, you should test the performance of the database after executing the command and be prepared to restore the backup made before executing the `Repair` command if you find that the command results in decreased performance.

The initialization of free pages requires access to the Oracle `Rdb` system tables. You should not initialize free pages until you know that the `RDB$SYSTEM` storage area (where the system tables are stored) is not corrupted.

- `Larea_Parameters=options-file`

This option specifies an options file (default file extension `.opt`) that contains a list of logical areas and parameter values that `RMU Repair` uses to update the area inventory page (AIP) before it builds the space area management (SPAM) pages.

The `Larea_Parameters` options file contains lines in the following format:

```
name [/Areas=name][/Delete][/[No]Thresholds=(n[,n[,n]])]/Length=n[/Type=option]
```

1.40 RMU Repair Command

A comment can be appended to the line (an exclamation point (!) is the comment character), and a line can be continued (as in DCL) by ending it with a hyphen (-).

The logical area can be specified by name or identification number (ID). The logical area named must be present in the AIP, or an error is generated. The Larea_Parameters options are further described as follows:

- Areas=name
Restricts this line to the logical area that resides in the specified storage area. The storage area can be specified by name or ID. By default, all logical areas with a matching name are altered independently of the storage area in which they reside.
You can specify storage area ID numbers with the Areas qualifier.
- Delete
Specifies that the logical area should be marked as deleted.

CAUTION

You will corrupt your database if you delete a logical area that is referenced by Oracle Rdb metadata.

- Length=n
The Initialize=Length option specifies the record length to store in the logical area inventory entry. RMU Repair uses this value to calculate SPAM thresholds.
When columns are deleted from or added to a table, the record length stored in the logical area inventory entry is not updated. Therefore the search for space needed to store a new record may be inefficient, and the SPAM thresholds will not be set properly. You can solve this problem by first correcting the length in the logical area inventory entry, then generating corrected SPAM pages using the RMU Repair command. See Example 2 in the Examples section.
- Thresholds=(n [,n [,n]])
NoThresholds
This option specifies the logical area SPAM thresholds. This is useful only for logical areas that reside in a storage area with a uniform page format. If thresholds are set, they are ignored in a storage area with a mixed page format.

1.40 RMU Repair Command

See the *Oracle Rdb7 Guide to Database Performance and Tuning* for information on setting SPAM thresholds.

The `Nothresholds` option specifies that logical area thresholds be disabled.

– `Type=keyword`

By specifying a `Type`, you can update the on-disk logical area type in the AIP. For databases created prior to Oracle Rdb release 7.0.1, the logical area type information in the AIP is unknown. However, the `RMU Show Statistics` utility depends on this information to display information on a per-logical-area basis. A logical area is a table, B-tree index, hash index, or any partition of one of these.

In order to update the on-disk logical area type in the AIP, specify the type as follows:

`Type=Table`

Specifies that the logical area is a data table, such as is created with the `SQL CREATE TABLE` statement.

`Type=Btree`

Specifies that the logical area is a B-tree index, such as is created with the `SQL CREATE INDEX TYPE IS SORTED` statement.

`Type=Hash`

Specifies that the logical area is a hash index, such as is created with the `SQL CREATE INDEX TYPE IS HASHED` statement.

`Type=System`

Specifies that the logical area is a system record that is used to identify hash buckets. Users cannot explicitly create this type of logical area. This type should not be used for the `RDB$SYSTEM` logical areas. It does not identify system relations.

`Type=Blob`

Specifies that the logical area is a BLOB (LIST OF BYTE VARYING) repository.

There is no error checking of the type specified for a logical area. The specified type does not affect the collection of statistics, nor does it affect the reading of the affected logical areas. However, an incorrect type will cause incorrect statistics to be reported by the `RMU Show Statistics` utility.

• `Only_Larea_Type`

The `Initialize=Only_Larea_Type` option specifies that only the logical area type field is to be updated in the area inventory page (AIP).

1.40 RMU Repair Command

- Snapshots

The Snapshots option allows you to create and initialize new snapshot files. In addition, it removes corrupt snapshot area pages from the Corrupt Page Table (CPT). This is much faster than using the RMU Restore command to do the same thing, especially when just one snapshot file is lost and needs to be created again. The default is not to create new files.

When you specify the Confirm option with the Initialize=Snapshots option (Initialize=Snapshots=Confirm), you can use the RMU Repair command not only to initialize, but also to optionally rename, move, or change the allocation of snapshot files.

These operations might be necessary when a disk with a snapshot file has a hardware problem or is removed in a hardware upgrade, or when a snapshot file has grown too large and you want to truncate it.

The Confirm option causes RMU Repair to prompt you for a name and allocation for one or more snapshot files. If you use the Areas qualifier, you can select the snapshot files in the database that you want to modify. If you omit the Areas qualifier, all the snapshot files for the database are initialized and RMU Repair prompts you interactively for an alternative file name and allocation for each snapshot file. By specifying a new file name for a snapshot file, you can change the location of the snapshot file. By specifying a new allocation for a snapshot file, you can truncate a snapshot file or make it larger.

- Tsns

The Initialize=Tsns option resets the database transaction state. The default is to not alter the transaction state.

After-image journaling is disabled when you specify the Initialize=Tsns option. You must explicitly enable after-image journaling after the RMU Repair command completes if you want journaling enabled.

This operation is useful when the database transaction sequence number (TSN) approaches the maximum allowable value and the TSN values must be initialized to zero. The TSN value is contained in a quadword with the following decimal format:

```
high longword : low longword
```

The high longword can hold a maximum user value of 32768 (2^{15}) and the low longword can hold a maximum user value of 4,294,967,295 (2^{32}). A portion of the high-longword is used by Oracle Rdb for overhead.

1.40 RMU Repair Command

Initialization of the TSN values requires reading and writing to each page of the database, so the Areas qualifier is not meaningful. It also requires initialization of the snapshot areas even if the Snapshots option has not been specified.

The Tsns initialization option carries the following restrictions:

- It cannot be performed if the Replication Option for Rdb is being used unless all transfers have been completed. RMU Repair will ask for confirmation if an RDB\$TRANSFERS table is defined.
- Old journal files will not be applicable to this repaired database. After TSNs have been initialized, you must reenable after-image journaling if you want journaling enabled.

After the RMU Repair command completes, a full and complete backup operation should be performed on the database as soon as is practical. This operation ensures that new journaled changes can be applied to the restored database in the event that a restore operation should become necessary.

Spams

Nospams

Reconstructs the SPAM pages for the areas you specify with the Areas qualifier. If you specify the Nospams qualifier, the SPAM pages are not reconstructed. The default is the Spam qualifier if you do not specify any of the following qualifiers for the RMU Repair command:

- ABM
- Initialize=Free_Pages
- Initialize=Snapshots
- Initialize=Snapshots=Confirm

If you use any of these qualifiers, the NoSpam qualifier is the default.

When columns are deleted from or added to a table, the record length stored in the logical area inventory entry is not updated. Therefore the search for space needed to store a new record may be inefficient, and the SPAM thresholds will not be set properly. You can solve this problem by first correcting the length in the logical area inventory entry, then generating corrected SPAM pages using the RMU Repair command. See Example 2 in the Examples section.

Tables[=table-list]

Specifies the list of tables that you want RMU Repair to check for complete segmented strings.

1.40 RMU Repair Command

If no tables are listed, then all nonsystem tables are examined. (System tables do not store their segmented strings in write-once areas.) Note that RMU Repair has no knowledge of which storage areas contain segmented strings from a particular table; thus, the default is to search all tables.

Usage Notes

- To use the RMU Repair command for a database, you must have the RMU\$ALTER privilege in the root file access control list (ACL) for the database or the OpenVMS SYSPRV or BYPASS privilege.
- Enable detected asynchronous prefetch to achieve the best performance of this command. Beginning with Oracle Rdb V7.0, by default, detected asynchronous prefetch is enabled. You can determine the setting for your database by issuing the RMU Dump command with the Header qualifier.

If detected asynchronous prefetch is disabled, and you do not want to enable it for the database, you can enable it for your RMU Repair operations by defining the following logicals at the process level:

```
$ DEFINE RDM$BIND_DAPF_ENABLED 1
$ DEFINE RDM$BIND_DAPF_DEPTH_BUF_CNT P1
```

P1 is a value between 10 and 20 percent of the user buffer count.

- The Areas qualifier can be used with indirect file references. See Section 1.3.
- Oracle Corporation recommends that you use the RMU Backup command to perform a full backup operation on your database before using the RMU Repair command on the database.
- Use the SQL SHOW STORAGE AREA statement to display the new location of a snapshot (.snp) file and the RMU Dump command with the Header qualifier to display the new allocation.
- Be careful when you specify names for new .snp files with the RMU Repair command. If you specify the name of a file that already exists and was created for the database, it will be initialized as you requested.

If you mistakenly initialize a live database file in this way, do not use the database until the error is corrected. Use the RMU Restore command to restore the database to the condition it was in when you backed it up just prior to issuing the RMU Repair command. If you did not back up the database before issuing the RMU Repair command, you must restore the database from your most recent backup file and then recover from .aij files (if the database had after-image journaling enabled).

1.40 RMU Repair Command

If you specify the wrong .snp file (for example, if you specify jobs.snp for all the .snp file name requests in Example 3 in the Examples section), you can correct this by issuing the RMU Repair command again with the correct .snp file names.

After the RMU Repair command completes, delete old .snp files and use the RMU Backup command to perform a full backup operation on your database.

Examples

Example 1

The following command repairs SPAM page corruption for all the storage areas in the mf_personnel database. No area bit map (ABM) pages are reconstructed because the Abm qualifier is not specified.

```
$ RMU/REPAIR MF_PERSONNEL
```

Example 2

When columns are deleted from or added to a table, the record length stored in the logical area inventory entry is not updated. Therefore the search for space needed to store a new record may be inefficient, and the SPAM thresholds will not be set properly. You can solve this problem by first correcting the length in the logical area inventory entry, then generating corrected SPAM pages using the RMU Repair command.

For example, suppose the Departments table was stored in the departments.rda uniform page format storage area and the Budget_Projected column (integer data type = 4 bytes) was deleted. As a result of this deletion, the row length changed from 47 bytes to 43 bytes. You can specify a smaller record length (43 bytes) in the fix_departments.opt options file to more efficiently use space in the storage area.

```
$ CREATE FIX_DEPARTMENTS.OPT
DEPARTMENTS /LENGTH=43
```

Then, the following RMU Repair command specifies the record length to store in the logical area inventory entry for this logical area and rebuilds the SPAM pages:

```
$ RMU/REPAIR/SPAMS/INITIALIZE=LAREA_PARAMETERS=FIX_DEPARTMENTS.OPT -
_ $ MF_PERSONNEL
```

Example 3

1.40 RMU Repair Command

The following RMU Repair command initializes and renames departments.snp; initializes and moves salary_history.snp; and initializes, moves, and truncates jobs.snp:

```
$ RMU/REPAIR/NOSPAMS/INITIALIZE=SNAPSHOTS=CONFIRM -
_ $ /AREAS=(DEPARTMENTS,JOBS,SALARY_HISTORY) MF_PERSONNEL
%RMU-I-FULBACREQ, A full backup of this database should be
performed after RMU Repair
Area DEPARTMENTS snapshot filename
[SQL1:[TEST]DEPARTMENTS.SNP;1]: NEW_DEPT
Area DEPARTMENTS snapshot file allocation [10]?
Area SALARY_HISTORY snapshot filename
[SQL1:[TEST]SALARY_HISTORY.SNP;1]: SQL2:[TEST]
Area SALARY_HISTORY snapshot file allocation [10]?
Area JOBS snapshot filename [SQL1:[TEST]JOBS.SNP;1]: SQL2:[TEST2]
Area JOBS snapshot file allocation [10]? 5
```

Example 4

The following RMU Repair command finds incorrect checksums in the EMPIDS_LOW storage area and updates them to reflect the correct checksum:

```
$ RMU/REPAIR MF_PERSONNEL.RDB/AREA=EMPIDS_LOW/CHECKSUM
```

Example 5

The following command updates an AIP type for a table:

```
$ RMU/REPAIR MF_PERSONNEL /INITIALIZE=LAREA_PARAMETERS=TABLE.OPT
```

Type the TABLE.OPT file to show the contents of the file.

```
$ TYPE TABLE.OPT
EMPLOYEES /TYPE=TABLE
```

Example 6

The following command updates an AIP type for a storage area:

```
$ RMU/REPAIR MF_PERSONNEL /INITIALIZE=LAREA_PARAMETERS=AREAS.OPT
```

Type the AREAS.OPT file to show the contents of the file.

```
$ TYPE AREAS.OPT
EMPLOYEES /AREA=EMPIDS_OVER /TYPE=TABLE
```

1.41 RMU Resolve Command

1.41 RMU Resolve Command

Resolves all unresolved distributed transactions for the specified database. For more information on unresolved transactions, see the *Oracle Rdb7 Guide to Distributed Transactions* and the *Oracle Rdb Release Notes*.

Format

RMU/Resolve root-file-spec

Command Qualifiers

/[No]Confirm
/[No]Log
/Parent_Node=node-name
/Process=process-id
/State=options
/Tsn=tsn

Defaults

See description
Setting of DCL VERIFY flag
See description
See description
None
See description

Description

Use the RMU Resolve command to commit or abort any unresolved distributed transactions in the database. You must resolve the unresolved transactions to the same state (Commit or Abort) in every database affected by the unresolved transactions.

RMU Resolve performs the following tasks:

- Displays identification information for an unresolved transaction.
- Prompts you for the state (Commit or Abort) to which you want the unresolved transaction resolved (if you did not specify the State qualifier on the command line).
- Prompts you for confirmation of the state you chose.
- Commits or aborts the unresolved transaction. If you commit or abort the unresolved transaction, it is resolved and cannot be resolved again.
- Continues to display and prompt for states for subsequent unresolved transactions until it has displayed information for all unresolved transactions.

1.41 RMU Resolve Command

Use the `Parent_Node`, `Process`, or `Tsn` qualifiers to limit the number of unresolved transactions that Oracle RMU displays. Use the `Users` and `State=Blocked` qualifiers with the `RMU Dump` command to determine values for the `Parent_Node`, `Process`, and `Tsn` qualifiers.

Command Parameters

root-file-spec

The database root file for which you want to resolve unresolved transactions.

Command Qualifiers

Confirm**Noconfirm**

Prompts you for confirmation of each unresolved transaction. This is the default for interactive processing.

Specify the `Noconfirm` qualifier to suppress this prompt. This is the default for batch processing.

Log**Nolog**

Specifies whether the processing of the command is reported to `SYS$OUTPUT`. Specify the `Log` qualifier to request that summary information about the resolve operation be reported to `SYS$OUTPUT` and the `Nolog` qualifier to prevent this reporting. If you specify neither, the default is the current setting of the `DCL VERIFY` flag. (The `DCL SET VERIFY` command controls the setting of the `DCL VERIFY` flag.)

Parent_Node=node-name

Specifies the node name to limit the selection of transactions to those originating from the specified node. If you omit the `Parent_Node` qualifier, `RMU Resolve` includes transactions originating from all nodes.

You cannot specify the `Tsn` or `Process` qualifier with the `Parent_Node` qualifier.

The `Parent_Node` qualifier is not valid for XA transactions.

Process=process-id

Specifies the process identification to limit the selection of transactions to those associated with the specified process. If you omit this qualifier, `RMU Resolve` includes all processes with transactions attached to the specified database.

You cannot specify the `Parent_Node` or `Tsn` qualifier with the `Process` qualifier.

1.41 RMU Resolve Command

State=options

Specifies the state to which all unresolved transactions be resolved.

Options for the State qualifier are:

- Commit—Commits unresolved transactions.
- Abort—Aborts unresolved transactions.

If you do not specify the State qualifier, RMU Resolve prompts you to enter an action, Commit or Abort, for each unresolved transaction on that database.

Tsn=tsn

Specifies the transaction sequence number (TSN) of the unresolved transactions whose state you want to modify.

The TSN value is contained in a quadword with the following decimal format:

high longword : low longword

The high longword can hold a maximum user value of 32768 (2^{15}) and the low longword can hold a maximum user value of 4,294,967,295 (2^{32}). A portion of the high longword is used by Oracle Rdb for overhead.

When you specify a TSN, you can omit the high longword and the colon if the TSN fits in the low longword. For example 0:444 and 444 are both valid TSN input values.

If you omit the Tsn qualifier, RMU Resolve includes all the unresolved transactions. You cannot specify the Parent_Node or the Process qualifier with the Tsn qualifier.

Usage Notes

- To use the RMU Resolve command for a database, you must have the RMU\$RESTORE privilege in the root file ACL for the database or the OpenVMS SYSPRV or BYPASS privilege.

Examples

Example 1

The following command specifies that the first displayed unresolved transaction in the MF_PERSONNEL database be changed to the Abort state and rolled back:

```
$ RMU/RESOLVE/LOG/STATE=ABORT MF_PERSONNEL
```

1.41 RMU Resolve Command

Example 2

The following command will display a list of all transactions coordinated by node GREEN and might be useful if node GREEN failed while running an application that used the DECdtm two-phase commit protocol:

```
$ RMU/RESOLVE/PARENT_NODE=GREEN MF_PERSONNEL
```

Example 3

The following command displays a list of all transactions initiated by process 41E0364A. The list might be useful for resolving transactions initiated by this process if the process were deleted.

```
$ RMU/RESOLVE/PROCESS=41E0364A MF_PERSONNEL
```

Example 4

The following command completes unresolved transactions for the MF_PERSONNEL database, and confirms and logs the operation:

```
$ RMU/RESOLVE/LOG/CONFIRM MF_PERSONNEL
```

For more examples of the RMU Resolve command, see the *Oracle Rdb7 Guide to Distributed Transactions*.

1.42 RMU Restore Command

1.42 RMU Restore Command

Restores a database to the condition it was in at the time a full or incremental backup operation was performed with an RMU Backup command. In addition, if after-image journal (.aij) files have been retained, RMU Restore attempts to apply any pre-existing .aij files to recover the database completely. See the Description section for details on the conditions under which RMU Restore attempts an automatic .aij file recovery as part of the restore operation.

When you use the RMU Restore command to restore the database to a system with a more recent version of Oracle Rdb software, an RMU Convert command with the Noconfirm and Commit qualifiers is automatically executed as part of RMU Restore. Therefore, by executing the RMU Restore command, you convert that database to the current version. See the *Oracle Rdb Installation and Configuration Guide* for the proper backup procedure prior to installing a new release of Oracle Rdb and restoring (or converting) databases.

Note

When you restore a database, default or propagated OpenVMS access control entries (ACEs) for the database root (.rdb) file take precedence over any Oracle RMU database access you might have.

Therefore, if default or propagated entries are in use, you must use the RMU Show Privilege and RMU Set Privilege commands after a restore operation completes to verify and correct the Oracle RMU access. (You can tell if default or propagated entries are in use because RMU Restore displays the warning message “RMU-W-PREVACL, Restoring the root ACL over a pre-existing ACL”. This is a normal condition if the RMU Restore command was invoked from the CDO utility.)

To use RMU Show Privilege and RMU Set Privilege commands, you must have the rights to edit the access control list (ACL) using RMU\$SECURITY access (which is VMS BIT_15 access in the access control entry (ACE)) and also (READ+WRITE+CONTROL) access. (Note that you can grant yourself BIT_15 access by using the DCL SET ACL command if you have (READ+WRITE+CONTROL) access.)

If you do not have the required access after a restore operation to make the needed changes, someone with the required access or OpenVMS BYPASS or SECURITY access must examine and correct the ACL.

This behavior exists in Oracle RMU to prevent someone from using Oracle RMU to override the existing OpenVMS security policy.

1.42 RMU Restore Command

Format

RMU/Restore backup-file-spec [storage-area-name[...]]

Command Qualifiers

/[No]Acl
 /Active_IO=max-reads
 /[No]After_Journal=file-spec
 /[No]Aij_Options=journal-opts
 /Area
 /[No]Cdd_Integrate
 /Close_Wait=n
 /[No]Commit
 /[No]Confirm
 /Directory=directory-spec
 /Disk_File=(Reader_Threads=n)
 /[No]Duplicate
 /Encrypt=({Value=|Name=}{[,Algorithm=]})
 /Global_Buffers=global-buffer-options
 /Incremental
 /Journal=file-name
 /Just_Corrupt
 /Label=(label-name-list)

/Librarian[=options]
 /Loader_Synchronization
 /Local_Buffers=local-buffer-options
 /[No]Log[=Brief|Full]
 /Master
 /[No]Media_Loader
 /[No]New_Version
 /Nodes_Max=number-cluster-nodes
 /[No]Online
 /Open_Mode={Automatic|Manual}
 /Options=file-spec
 /Page_Buffers=number-buffers
 /Path=cdd-path
 /Prompt={Automatic|Operator|Client}
 /[No]Recovery[=Aij_Buffers=n]
 /[No]Rewind
 /Root=root-file-spec
 /Transaction_Mode=(mode-list)
 /Users_max=number-users
 /Volumes=n

Defaults

/Acl
 /Active_IO=3
 See description
 See description
 See description
 /Cdd_Integrate
 See description
 /Commit
 See description
 See description
 /Disk_File=(Reader_Threads=1)
 /Noduplicate
 See description
 Current value
 Full restore
 See description
 See description
 See description

None
 See description
 Current value
 Current DCL verify value
 See description
 See Description
 /Nonew_Version
 See description
 /Noonline
 Current value
 None
 /Page_Buffers=3
 Existing value
 See description
 See description
 /Norewind
 Existing value
 /Transaction_Mode=Current
 Existing value
 /Volumes=1

1.42 RMU Restore Command

<u>File or Area Qualifiers</u>	<u>Defaults</u>
/Blocks_Per_Page=integer	See description
/Extension= {Disable Enable}	Current value
/File=file-spec	See description
/Just_Corrupt	See description
/Read_Only	Current value
/Read_Write	Current value
/Snapshot=(Allocation=n,File=file-spec)	See description
/[No]Spams	Current value
/Thresholds=(val1[,val2[,val3]])	Current value

Description

RMU Restore rebuilds a database from a backup file, produced earlier by an RMU Backup command, to the condition the database was in when the backup operation was performed and attempts to automatically recover the .aij files to provide a fully restored and recovered database.

You can specify only one backup file parameter in an RMU Restore command. If this parameter is a full backup file, you cannot use the Incremental qualifier. However, you must use the Incremental qualifier if the parameter names an incremental backup file.

RMU Restore attempts automatic .aij file recovery by default when you issue a database restore command if you are using fixed-size .aij files, if .aij files have been retained, and if a database conversion has not been performed. (The .aij files are not retained when you specify any of the following qualifiers: Aij_Options, After_Journal, or Duplicate.) RMU Restore does not attempt automatic .aij file recovery if you have backed up any of your .aij files (using the RMU Backup After_Journal command) because RMU Restore has no knowledge of those backup files.

In addition, success of the automatic .aij file recovery operation requires that the following criteria be met:

- Fixed-size after-image journaling is in effect.
- The .aij files must be on disk (not on tape).
- The .aij files must not have been marked as inaccessible at the time the database backup operation was performed.
- The .aij files must exist and have proper privileges for both read and write operations.

1.42 RMU Restore Command

- The .ajj files must be able to be accessed exclusively; failure indicates that an .ajj file is in use by another database user.
- The .ajj files must have a nonzero length.
- The .ajj files must have valid header information that corresponds to the current Oracle Rdb product and version number.
- The sequence number in the .ajj file header must not conflict with the restored definition in the database root information.
- The original .rdb file name must not exist.

Note

RMU Restore attempts automatic .ajj file recovery when you restore a database from a full, incremental, by-area, or by-page backup file. However, in some cases, you will want to disable this feature by using the Norecovery qualifier. Specifically, you should specify the Norecovery qualifier if either of the following are true:

- You are restoring the database from a previous version of Oracle Rdb.
- You need to issue more than one RMU Restore command to completely restore the database.

For example, if you intend to restore a database by first issuing a full RMU Restore command followed by the application of one or more RMU Restore commands with the Incremental or Area qualifiers, you *must* specify the Norecovery qualifier on all but the last RMU Restore command in the series you intend to issue. Allowing Oracle RMU to attempt automatic recovery with a full restore operation when you intend to apply additional incremental, by-area, or by-page backup files can result in a corrupt database.

RMU Restore does not attempt automatic .ajj file recovery if any of the following conditions are true:

- The database has been converted since the time you created the backup file that you are attempting to restore.
- The first .ajj file is not available (perhaps because it has been backed up).
- After-image journaling was disabled when the backup operation was performed.

1.42 RMU Restore Command

- After-image journaling was disabled when the database (or portion of it) was lost.
- You specify the `Aij_Options`, `After_Journal`, or `Duplicate` qualifier with the RMU Restore command.

If RMU Restore attempts automatic `.aij` file recovery but fails, you can still recover your database by using the RMU Recover command if the restore operation was successful.

Note

Using the DCL COPY command with a multfile database (assuming the files are copied to a new location) will result in an unsupported, unusable database. This happens because the DCL COPY command cannot update the full file specification pointers (stored in the database root file) to the other database files (`.rda`, `.snp`, and optional `.aij`).

You can rename or move the files that comprise a multfile Oracle Rdb database by using one of the following commands:

- The RMU Backup and RMU Restore commands
- The SQL EXPORT and IMPORT statements
- The RMU Move_Area command
- The RMU Copy_Database command

By default, RMU Restore integrates the metadata stored in the database root (`.rdb`) file with the data dictionary copy of the metadata (assuming the data dictionary is installed on your system). However, you can prevent dictionary integration by specifying the `Nocdd_Integrate` qualifier.

When you specify the `Incremental` or `Area` qualifiers, do not specify the following additional qualifiers:

- Directory
- Nodes_Max
- New_Version
- Nonew_Version
- Users_Max

The RMU Restore command ignores the `Confirm` qualifier if you omit the `Incremental` qualifier. Also, you must specify the `Root` qualifier when you restore an incremental backup file to a new version of the database, renamed database, or a restored database in a new location.

1.42 RMU Restore Command

See the Usage Notes section for information on restoring a database from tape.

Command Parameters

backup-file-spec

A file specification for the backup file produced by a previous RMU Backup command. Note that you cannot perform a remote restore operation on an .rbf file that has been backed up to tape and then copied to disk.

The default file extension is .rbf.

Depending on whether you are performing a restore operation from magnetic tape, disk, or multiple disks, the backup file specification should be specified as follows:

- To restore from magnetic tape:

If you used multiple tape drives to create the backup file, the backup-file-spec parameter must be provided with (and only with) the first tape drive name. Additional tape drive names must be separated from the first and subsequent tape drive names with commas, as shown in the following example:

```
$ RMU/RESTORE /REWIND $111$MUA0:PERS_FULLL_NOV30.RBF,$112$MUA1:
```

- To restore from single or multiple disk files:

If you used multiple disk files to create the backup file, the backup-file-spec parameter must be provided with (and only with) the first disk device name. Additional disk device names must be separated from the first and subsequent disk device names with commas. You must also be sure to include the Disk_File qualifier. For example:

```
$ RMU/RESTORE/DISK_FILE DISK1:[DIR1]MFP.RBF,DISK2:[DIR2],DISK3:[DIR3]
```

As an alternative to listing the disk device names on the command line (which, if you use several devices, can exceed the line-limit length for a command line), you can specify an options file in place of the backup-file-spec. For example:

```
$ RMU/RESTORE/DISK_FILE "@DEVICES.OPT"
```

The contents of devices.opt might appear as follows:

```
DISK1:[DIR1]MFP.RBF  
DISK2:[DIR2]  
DISK3:[DIR3]
```

1.42 RMU Restore Command

The backup files referenced from such an options file are:

```
DISK1:[DIR1]MFP.RBF
DISK2:[DIR2]MFP01.RBF
DISK3:[DIR3]MFP02.RBF
```

storage-area-name[,...]

A storage area name from the database. This parameter is optional. Use it in the following situations:

- When you want to change the values for thresholds or blocks per page.
- When you want to change the names specified with the Snapshot or the File qualifier for the restored database.
- If you want to restore only selected storage areas from your backup file, you must use the Area qualifier and specify the names of the storage areas you want to restore in either the storage-area-name parameter in the RMU Restore command line, or in the file specified with the Options qualifier.

To use this option, specify the storage area *name* rather than the file specification for the storage area.

By using the RMU Backup and RMU Restore commands, you can back up and restore selected storage areas of your database. This Oracle RMU backup and restore by-area feature is designed to:

- Speed recovery when corruption occurs in some (not all) of the storage areas of your database.
- Reduce the time needed to perform backup operations because some data (data in read-only storage areas, for example) does not need to be backed up with every backup operation performed on the database.

If you plan to use the RMU Backup and RMU Restore commands to back up and restore only selected storage areas for a database, you *must* perform full and complete backup operations on the database at regular intervals. A full and complete backup is a full backup (*not* an incremental backup) operation on *all* the storage areas in the database. If the database root (.rdb) file is corrupted, you can only recover storage areas up to (but not past) the date of the last full and complete backup operation. Therefore, Oracle Corporation recommends that you perform full and complete backup operations regularly.

If you plan to back up and restore only selected storage areas for a database, Oracle Corporation strongly recommends that you enable after-image journaling for the database (in addition to performing the full and complete backup operation on the database as described earlier). That is, if you are not backing up and restoring *all* the storage areas in your database, you should have after-image journaling enabled. This ensures that you can recover all

1.42 RMU Restore Command

the storage areas in your database in the event of a system failure. If you *do not* have after-image journaling enabled and one or more of the areas restored by RMU Restore are not current with the storage areas not restored, Oracle Rdb will not allow any transactions to use the storage areas that are not current in the restored database. In this situation, you can return to a working database by restoring the database, using the backup file from the last full and complete backup operation on the database storage areas. However, any changes made to the database since the last full and complete backup operation was performed are not recoverable.

If you have after-image journaling enabled, use the RMU Recover command to apply transactions from the .ajj file to storage areas that are not current after the RMU Restore command completes. When the RMU Recover command completes, your database will be consistent and usable.

Command Qualifiers

Acl

Noacl

Allows you to specify whether to restore the root file access control list (ACL) that was backed up.

If you specify the Acl qualifier, the root file ACL that was backed up is restored with the database. If the root file ACL was not backed up and you specify the Acl qualifier with the RMU Restore command, then RMU Restore restores the database without a root file ACL.

If you specify the Noacl qualifier, the root file ACL is not restored with the database.

The default is the Acl qualifier.

Active_IO=max-reads

Specifies the maximum number of read operations from the backup file that RMU Restore attempts simultaneously. The value of the Active_IO qualifier can range from 1 to 5. The default value is 3. Values larger than 3 might improve performance with multiple tape drives.

After_Journal=file-spec

Noafter_Journal

Note

This qualifier is maintained for compatibility with versions of Oracle Rdb prior to Version 6.0. You might find it more useful to specify

1.42 RMU Restore Command

the `Aij_Options` qualifier, unless you are interested in creating an extensible `.ajj` file only. (An **extensible .ajj file** is one that is extended by a specified amount when it reaches a certain threshold of fullness—assuming there is sufficient space on the disk where it resides.)

Specifies how RMU Restore is to handle after-image journaling and `.ajj` file creation, using the following rules:

- If you specify the `After_Journal` qualifier and provide a file specification, the RMU process creates a new extensible `.ajj` file and enables journaling.
- If you specify the `After_Journal` qualifier but you do not provide a file specification, RMU Restore creates a new extensible `.ajj` file with the same name as the journal that was active at the time of the backup operation.
- If you specify the `Noafter_Journal` qualifier, RMU Restore disables after-image journaling and does not create a new `.ajj` file. Note that if you specify the `Noafter_Journal` qualifier there will be a gap in the sequence of the `.ajj` files. For example, suppose your database has `.ajj` file sequence number 1 when you back it up. If you issue an RMU Restore command with the `Noafter_Journal` qualifier, the `.ajj` file sequence number will be changed to 2. This means that you cannot (and do not want to) apply the original `.ajj` file to the restored database (doing so would result in a sequence mismatch).
- If you do not specify an `After_Journal`, `Noafter_Journal`, `Aij_Options`, or `Noajj_Options` qualifier, RMU Restore recovers the journal state (enabled or disabled) and tries to reuse the `.ajj` file or files. (See the Description section for details on when automatic `.ajj` file recovery is not attempted.)

When you specify an `.ajj` file name, you should specify a new device and directory for the `.ajj` file. If you do not specify a device and directory, you receive a warning message. To protect yourself against media failures, put the `.ajj` file on a different device from that of your database files.

If the original database is lost or corrupted but the journal files are unaffected, you would typically restore the database without the use of either the `Aij_Options` or the `After_Journal` qualifier.

The `After_Journal` qualifier conflicts with the `Area` and `Incremental` qualifiers; you cannot specify the `After_Journal` qualifier and either of these two other qualifiers in the same RMU Restore command line.

You cannot use the `After_Journal` qualifier to create fixed-size `.ajj` files; use the `Aij_Options` qualifier.

1.42 RMU Restore Command

Aij_Options=journal-opts

Noaij_Options

Specifies how RMU Restore is to handle after-image journaling and .aij file creation, using the following rules:

- If you specify the Aij_Options qualifier and provide a journal-opts file, RMU Restore creates the .aij file or files you specify for the restored database. If only one .aij file is created for the restored database, it will be an extensible .aij file. If two or more .aij files are created for the restored database, they will be fixed-size .aij files (as long as at least two .aij files are always available). Depending on what is specified in the options file, after-image journaling can either be disabled or enabled.
- If you specify the Aij_Options qualifier, but do not provide a journal-opts file, RMU Restore disables journaling and does not create any new .aij files.
- If you specify the Noaij_Options qualifier, RMU Restore reuses the original .aij file configuration and recovers the journaling state (enabled or disabled) from the backed-up .aij file.
- If you do not specify an After_Journal, Noafter_Journal, Aij_Options, or Noaij_Options qualifier, RMU Restore recovers the journaling state (enabled or disabled) and tries to reuse the .aij file or files. (This is the same as specifying the Noaij_Options qualifier.)

See the Description section for details on when automatic .aij file recovery is not attempted.

The Aij_Options qualifier conflicts with the Area and Incremental qualifiers; you cannot specify the Aij_Options qualifier and either of these two other qualifiers in the same RMU Restore command line.

If the original database is lost or corrupted but the journal files are unaffected, you would typically restore the database without the use of either the Aij_Options or the After_Journal qualifier.

See Section 1.61.1 for information on the format of a journal-opts-file.

Area

Specifies that only the storage areas listed in the storage-area-name parameter on the command line or in the Options file are to be restored. You can use this qualifier to simplify physical restructuring of a large database.

By default, the Area qualifier is not specified. When the Area qualifier is not specified, all the storage areas and the database root (.rdb) file are restored. Therefore, if you want to restore all the storage areas, omit the Area qualifier. If you specify the Area qualifier, a valid database root must exist. (First issue

1.42 RMU Restore Command

the RMU Restore Only Root command with a full backup file to create a valid database if one does not exist.)

By using the RMU Backup and RMU Restore commands, you can back up and restore selected storage areas of your database. This Oracle RMU backup- and restore-by-area feature is designed to:

- Speed recovery when corruption occurs in some (not all) of the storage areas of your database.
- Reduce the time needed to perform backup operations because some data (data in read-only storage areas, for example) does not need to be backed up with every backup operation performed on the database.

Note

When you perform a by-area restore operation, an area may be marked as inconsistent; that is, the area may not be at the same transaction state as the database root when the restore operation completes. This may happen, for example, when automatic .aij recovery is disabled with the Norecovery qualifier, or if automatic recovery fails. You can check to see if an area is consistent by using the RMU Show Corrupt_Pages command. If you find that one or more areas are inconsistent, use the RMU Recover command to apply the .aij files. If the .aij files are not available, refer to the section on Clearing an Inconsistent Flag in the *Oracle Rdb Guide to Database Maintenance* for information on the implications of setting a corrupt area to consistent. Then refer to Section 1.53 for information on using the Set Corrupt_Pages command to clear the inconsistent flag.

If you attempt to restore a database area that is not in the backup file, you receive an error message and, typically, the database will be inconsistent or unusable until the affected area is properly restored.

In the following example, the DEPARTMENTS storage area is excluded from the backup operation; therefore, a warning message is displayed when the attempt is made to restore DEPARTMENTS, which is not in the backup file. Note that when this restore operation is attempted on a usable database, it completes, but the DEPARTMENTS storage area is now inconsistent.

```
$ RMU/BACKUP /EXCLUDE=DEPARTMENTS MF_PERSONNEL.RDB -
_ $ PERS_BACKUP5JAN88.RBF
$ RMU/RESTORE /NEW_VERSION /AREA PERS_BACKUP5JAN88.RBF DEPARTMENTS
%RMU-W-AREAEXCL, The backup does not contain the storage
area - DEPARTMENTS
```

1.42 RMU Restore Command

If you create a backup file by using the RMU Backup command and the Exclude qualifier, it is your responsibility to ensure that all areas of a database are restored and recovered when you use the RMU Restore and RMU Recover commands to duplicate the database.

The Area qualifier conflicts with the After_Journal and Aij_Options qualifiers.

Cdd_Integrate

Nocdd_Integrate

Integrates the metadata from the database root (.rdb) file into the data dictionary (assuming the data dictionary is installed on your system).

If you specify the Nocdd_Integrate qualifier, no integration occurs during the restore operation.

You might want to delay integration of the database metadata with the data dictionary until after the restore operation finishes successfully.

You can use the Nocdd_Integrate qualifier even if the DICTIONARY IS REQUIRED clause was used when the database was defined.

The Cdd_Integrate qualifier integrates definitions *in one direction only*—from the database file to the dictionary. The Cdd_Integrate qualifier does *not* integrate definitions from the dictionary to the database file.

Close_Wait=n

Specifies a wait time of *n* minutes before RMU Restore automatically closes the database. You must supply a value for *n*.

In order to use this qualifier, the Open_Mode qualifier on the RMU Restore command line must be set to Automatic.

Commit

NoCommit

Instructs Oracle RMU to commit the converted database to the current version of Oracle Rdb before completing the restore operation. Use this qualifier only when the backup file being restored is from a previous version of Oracle Rdb. The conversion is permanent and the database cannot be returned to the previous version. The NoCommit qualifier instructs Oracle RMU not to commit the converted database. In this case, you can roll back the database to its original version using the RMU Convert command with the Rollback qualifier, or you can permanently commit it to the current version by issuing the RMU Convert command with the Commit qualifier.

The Commit qualifier is the default.

1.42 RMU Restore Command

Confirm

Noconfirm

Specifies that RMU Restore notify you of the name of the database on which you are performing the incremental restore operation. You can thus be sure that you have specified the correct .rdb file name to which the incremental backup file will be applied. This is the default for interactive processing.

Confirmation is especially important on an incremental restore operation if you have changed the .rdb file name or created a new version of the database during a restore operation from the full backup file. (You must specify the Root qualifier also to create new version or change the .rdb file name.)

Specify the Noconfirm qualifier to have RMU Restore apply the incremental backup file to the database without prompting for confirmation. This is the default for batch processing.

RMU Restore ignores the Confirm and Noconfirm qualifiers unless you use the Incremental qualifier.

Directory=directory-spec

Specifies the default destination for the restored database files. If you specify a file name or file extension, all restored files are given that file name or file extension. There is no default directory specification for this qualifier. If you do not specify the Directory qualifier, RMU Restore attempts to restore all the database files to the directories they were in at the time the backup file was created; if those directories no longer exist, the restore operation fails.

See the Usage Notes for information on how this qualifier interacts with the Root and File qualifiers and for warnings regarding restoring database files into a directory owned by a resource identifier.

Disk_File[=(Reader_Threads=integer)]

Specifies that you want to perform a multithreaded restore operation from disk files, floppy disks, or other disks external to the PC. This qualifier must have been specified on the RMU Backup command when the backup files from which you are restoring were created.

The Reader_Threads keyword specifies the number of threads that Oracle RMU should use when performing a multithreaded restore operation from disk files. You can specify no more than one reader thread per device specified on the command line (or in the command parameter options file). By default, one reader thread is used.

This qualifier and all qualifiers that control tape operations (Label, Loader_Synchronization, Master, Media_Loader, and Rewind) are mutually exclusive.

1.42 RMU Restore Command

Duplicate Noduplicate

Specifies a new database with the same content but different identity from that of the original database. The default is the Noduplicate qualifier.

The Duplicate qualifier creates a copy of your database that is not expected to remain in sequence with the original database. Note that you cannot interchange after-image journal (.aij) files between the original and duplicate copy of the database because each database is unique.

You can create a duplicate database when you use the Duplicate qualifier or create the original database again when you use the Noduplicate qualifier.

The Duplicate qualifier conflicts with the Incremental, Area, and Online qualifiers.

Encrypt={Value= | Name=}[,Algorithm=]

The Encrypt qualifier decrypts the save set file of a database backup.

Specify a key value as a string or, the name of a predefined key. If no algorithm name is specified the default is DESCBC. For details on the Value, Name and Algorithm parameters see HELP ENCRYPT.

This feature requires the OpenVMS Encrypt product to be installed and licensed on this system.

Global_Buffers=global-buffer-options

Allows you to change the default global buffer parameters when you restore a database. The following options are available:

- **Disabled**
Use this option to disable global buffering for the database being restored.
- **Enabled**
Use this option to enable global buffering for the database being restored. You cannot specify both the Global_Buffers=Disabled and Global_Buffers=Enabled qualifiers in the same RMU Restore command.
- **Total=total-buffers**
Use this option to specify the number of buffers available for all users. The minimum value you can specify is 2; the maximum value you can specify is the global buffer count stored in the .rdb file.
- **User_Limit=buffers-per-user**
Use this option to specify the maximum number of buffers available to each user.

1.42 RMU Restore Command

If you do not specify a `Global_Buffers` qualifier, the database is restored with the values that were in effect when the database was backed up.

When you specify two or more options with the `Global_Buffers` qualifier, use a comma to separate each option and enclose the list of options within parentheses.

Incremental

The `Incremental` qualifier restores a database from an incremental backup file.

Use the `Incremental` qualifier only when you have first issued an `RMU Restore` command that names the full backup file that was the basis for this incremental backup file. Each incremental backup file is tied to a particular full backup file.

After restoring both the full and the incremental backup files, you have restored the database to the condition it was in when you performed the incremental database backup operation.

By default, `RMU Restore` performs a full restore operation on the backup file.

You cannot specify the `After_Journal` or `Just_Corrupt` qualifier with the `Incremental` qualifier.

Journal=file-name

Allows you to specify a journal file to be used to improve tape performance by a restore operation (including a `by-area` or `just-corrupt` restore operation).

The backup operation creates the journal file and writes to it a description of the backup operation. This description contains identification of the tape drives, the tape volumes and their contents. The `Journal` qualifier directs `RMU Restore` to read the journal file and select only the useful tape volumes.

The journal file must be the one created at the time the backup operation was performed. If the wrong journal file is supplied, `RMU Restore` returns an informational message and does not use the specified journal file to select the volumes to be processed.

If you omit the `Label` qualifier, the restore operation creates a list of volume labels from the contents of the journal file.

A `by-area` restore operation also constructs a list of useful tape volume labels from the journal file; only those volumes are mounted and processed.

Just_Corrupt

You can apply the `Just_Corrupt` qualifier as a global qualifier, a local qualifier, or both. See the description of the `Just_Corrupt` qualifier under the list of `File` and `Area` Qualifiers for a description of all three uses.

1.42 RMU Restore Command

Label=(label-name-list)

Specifies the 1- to 6-character string with which the volumes of the backup file have been labeled. The Label qualifier is applicable only to tape volumes. You must specify one or more label names when you use the Label qualifier.

You can specify a list of tape labels for multiple tapes. If you list multiple tape label names, separate the names with commas, and enclose the list of names within parentheses.

In a normal restore operation, the Label qualifier you specify with the RMU Restore command should be the same Label qualifier you specified with the RMU Backup command that backed up your database.

You can use the Label qualifier with indirect file references. See Section 1.3 for more information.

Librarian[=options]

Use the Librarian qualifier to restore files from data archiving software applications that support the Oracle Media Management interface. The file name specified on the command line identifies the stream of data to be retrieved from the Librarian utility. If you supply a device specification or a version number it will be ignored.

Oracle RMU supports retrieval using the Librarian qualifier only for data that has been previously stored by Oracle RMU using the Librarian qualifier.

The Librarian qualifier accepts the following options:

- **Reader_Threads=n**

Use the Reader_Threads option to specify the number of backup data streams to read from the Librarian utility. The value of *n* can be from 1 to 99. The default is one reader thread. The streams are named BACKUP_FILENAME.EXT, BACKUP_FILENAME.EXT02, BACKUP_FILENAME.EXT03, up to BACKUP_FILENAME.EXT99. BACKUP_FILENAME.EXT is the backup file name specified in the RMU Backup command.

The number of reader threads specified for a database restore from the Librarian utility should be equal to or less than the number of writer threads specified for the database backup. If the number of reader threads exceeds the number of writer threads, the number of reader threads is set by Oracle RMU to be equal to the number of data streams actually stored in the Librarian utility by the backup. If the number of reader threads specified for the restore is less than the number of writer threads specified for the backup, Oracle RMU will partition the data streams among the

1.42 RMU Restore Command

specified reader threads so that all data streams representing the database are restored.

The Volumes qualifier cannot be used with the Librarian qualifier. Oracle RMU sets the volume number to be the actual number of data streams stored in the specified Librarian utility.

- `Trace_file=file-specification`

The Librarian utility writes trace data to the specified file.

- `Level_Trace=n`

Use this option as a debugging tool to specify the level of trace data written by the Librarian utility. You can use a pre-determined value of 0, 1, or 2, or a higher value defined by the Librarian utility. The pre-determined values are :

- Level 0 traces all error conditions. This is the default.
- Level 1 traces the entry and exit from each Librarian function.
- Level 2 traces the entry and exit from each Librarian function, the value of all function parameters, and the first 32 bytes of each read/write buffer, in hexadecimal.

- `Logical_Names=(logical_name=equivalence-value,...)`

You can use this option to specify a list of process logical names that the Librarian utility can use to specify catalogs or archives where Oracle Rdb backup files are stored, Librarian debug logical names, and so on. See the specific Librarian documentation for the definition of logical names. The list of process logical names is defined by Oracle RMU prior to the start of any Oracle RMU command that accesses the Librarian application.

The following OpenVMS logical names must be defined for use with a Librarian utility before you execute an Oracle RMU backup or restore operation. Do not use the `Logical_Names` option provided with the Librarian qualifier to define these logical names.

- `RMU$LIBRARIAN_PATH`

This logical name must be defined so that the shareable Librarian image can be loaded and called by Oracle RMU backup and restore operations. The translation must include the file type (for example, `.exe`), and must not include a version number. The shareable Librarian image must be an installed (known) image. See the Librarian utility documentation for the name and location of this image and how it should be installed. For a parallel RMU backup, define `RMU$LIBRARIAN_PATH` as a system-wide

1.42 RMU Restore Command

logical name so that the multiple processes created by a parallel backup can all translate the logical.

```
$ DEFINE /SYSTEM /EXECUTIVE_MODE -
_ $ RMU$LIBRARIAN_PATH librarian_shareable_image.exe
```

- **RMU\$DEBUG_SBT**

This logical name is not required. If it is defined, Oracle RMU will display debug tracing information messages from modules that make calls to the Librarian shareable image. For a parallel RMU backup, the RMU\$DEBUG_SBT logical should be defined as a system logical so that the multiple processes created by a parallel backup can all translate the logical.

The following lines are from a backup plan file created by the RMU Backup /Parallel/Librarian command:

```
Backup File = MF_PERSONNEL.RBF
Style = Librarian
Librarian_trace_level = #
Librarian_logical_names = (-
    logical_name_1=equivalence_value_1, -
    logical_name_2=equivalence_value_2)
Writer_threads = #
```

The "Style = Librarian" entry specifies that the backup is going to a Librarian utility. The "Librarian_logical_names" entry is a list of logical names and their equivalence values. This is an optional parameter provided so that any logical names used by a particular Librarian utility can be defined as process logical names before the backup or restore operation begins. For example, some Librarian utilities provide support for logical names for specifying catalogs or debugging.

You cannot use device specific qualifiers such as Rewind, Density, or Label with the Librarian qualifier because the Librarian utility handles the storage media, not Oracle RMU.

Loader_Synchronization

Allows you to preload tapes in order to minimize the need for operator support. When you specify the Loader_Synchronization qualifier and specify multiple tape drives, the restore operation reads from the first set of tape volumes concurrently, then waits until all concurrent tape operations conclude before assigning the next set of tape volumes. This ensures that the tapes can be loaded into the loaders or stackers in the order required by the restore operation.

1.42 RMU Restore Command

The `Loader_Synchronization` qualifier does result in reduced performance. For maximal performance, no drive should remain idle, and the next identified volume should be placed on the first drive that becomes idle. However, because the order in which the drives become idle depends on many uncontrollable factors and cannot be predetermined, the drives cannot be preloaded with tapes.

Because the cost of using the `Loader_Synchronization` qualifier is dependent on the hardware configuration and the system load, the cost is unpredictable. A 5% to 20% additional elapsed time for the operation is typical. You must determine whether the benefit of a lower level of operator support compensates for the loss of performance. The `Loader_Synchronization` qualifier is most useful for large restore operations.

The `Loader_Synchronization` qualifier has no effect unless you specify the `Volumes` qualifier also.

Local_Buffers=local-buffer-options

Allows you to change the default local buffer parameters when you restore a database. The following options are available:

- `Number=number-buffers`
Use this option to specify the number of local buffers available for all users. You must specify a number between 2 and 32,767 for the `number-buffers` parameter.
- `Size=buffer-blocks`
The size (in blocks) for each buffer. You must specify a number between 2 and 64 for the `buffer-blocks` parameter.
If you specify a value smaller than the size of the largest page defined, RMU Restore automatically adjusts the size of the buffer to hold the largest page defined. For example, if you specify the `Local_Buffers=Size=8` qualifier and the largest page size for the storage areas in your database is 64 blocks, RMU Restore automatically interprets the `Local_Buffers=Size=8` qualifier as though it were a `Local_Buffers=Size=64` qualifier.
The value you specify for the `Size` option determines the number of blocks for each buffer, regardless of whether local buffering or global buffering is enabled for the database.

If you do not specify a `Local_Buffers` qualifier, the database is restored with the values that were in effect when the database was backed up.

1.42 RMU Restore Command

Log

Log=Brief

Log=Full

Nolog

Specifies whether the processing of the command is reported to SYS\$OUTPUT. Specify the Log qualifier to request that the progress of the restore operation be written to SYS\$OUTPUT, or the Nolog qualifier to suppress this report. If you specify the Log=Brief option, which is the default if you use the Log option without a qualifier, the log contains the start and completion time of each storage area. If you specify the Log=Full option, the log also contains thread assignment and storage area statistics messages.

If you do not specify the Log or the Nolog qualifier, the default is the current setting of the DCL verify switch. (The DCL SET VERIFY command controls the DCL verify switch.)

Master

Allows you to explicitly state how drives should be used when they are to be accessed concurrently. This is a positional qualifier that designates a tape drive as a master tape drive.

When the Master qualifier is used, it must be used on the first drive specified. All additional drives become slaves to that master until the end of the command line, or until the next Master qualifier, whichever comes first.

If the Master qualifier is used on a drive that does not have an independent I/O path (not a hardware master), performance decreases.

If the Master qualifier is not used, and concurrent tape access is requested (using the Volumes=n qualifier), RMU Restore uses the same automatic configuration procedure it employs with the backup operation to select the master drives.

Using the Master qualifier is an error if you do not specify concurrent tape access (you do not specify the Volumes=n qualifier). See the description of the Volumes qualifier for further information on specifying concurrent tape access.

Media Loader

Nomedia Loader

Use the Media Loader qualifier to specify that the tape device from which RMU Restore is reading the backup file has a loader or stacker. Use the Nomedia Loader qualifier to specify that the tape device does not have a loader or stacker.

1.42 RMU Restore Command

By default, if a tape device has a loader or stacker, RMU Restore should recognize this fact. However, occasionally RMU Restore does not recognize that a tape device has a loader or stacker. Therefore, after reading the first tape, RMU Restore issues a request to the operator for the next tape, instead of requesting the next tape from the loader or stacker. Similarly, sometimes RMU Restore behaves as though a tape device has a loader or stacker when actually it does not.

If you find that RMU Restore is not recognizing that your tape device has a loader or stacker, specify the `Media_Loader` qualifier. If you find that RMU Restore expects a loader or stacker when it should not, specify the `Nomedia_Loader` qualifier.

New_Version

Nonew_Version

Specifies whether new versions of database files should be produced if the destination device and directory contain a previous version of the database files.

If you use the `New_Version` qualifier, the new database file versions are produced. The `New_Version` qualifier conflicts with the `Incremental` qualifier.

If you use the `Nonew_Version` qualifier, the default, an error occurs if an old copy exists of any of the database files being restored.

A restore operation that creates a new database root (.rdb) file must always either disable after-image journaling or create a new .aij file. Attempting to use a pre-existing .aij file with a restored database corrupts the journal and makes future recovery from .aij files impossible. The `New_Version` qualifier cannot and does not apply to the .aij file.

Nodes_Max=number-cluster-nodes

Specifies a new upper limit on the number of VMScluster nodes from which users can access the restored database. The `Nodes_Max` qualifier accepts values between 1 and 96 VMScluster nodes. The actual maximum is the highest number of VMScluster nodes possible in the current version of OpenVMS. The default value is the limit defined for the database before it was backed up.

You cannot specify the `Nodes_Max` qualifier if you use the `Incremental` or `Area` qualifier.

Online

Noonline

Specifies that the restore operation be performed while other users are attached to the database. You can specify the `online` qualifier only with

1.42 RMU Restore Command

the Area or Just_Corrupt qualifier. The pages to be restored are locked for exclusive access, so the operation is not compatible with any other use of the data in the specified pages.

The default is the Nonline qualifier.

Open_Mode=Automatic

Open_Mode=Manual

Allows you to change the mode for opening a database when you restore that database. When you specify Open_Mode=Automatic, users can invoke the database immediately after it is restored. If you specify Open_Mode=Manual, an RMU Open command must be used to open the database before users can invoke the database.

The Open_Mode qualifier also specifies the mode for closing a database. If you specify Open_Mode=Automatic, you can also use the Close_Wait qualifier to specify a time in minutes before the database is automatically closed.

If you do not specify the Open_Mode qualifier, the database is restored with the open mode of the database that was in effect when the database was backed up.

Options=file-spec

Specifies the options file that contains storage area names, followed by the storage area qualifiers that you want applied to that storage area.

You can direct RMU Restore to create an options file for use with this qualifier by specifying the Restore_Options qualifier with the RMU Backup, RMU Dump, and RMU Dump Backup commands. See Section 1.10, Section 1.19, and Section 1.21 for details.

If you create your own options file, *do not* separate the storage area names with commas. Instead, put each storage area name on a separate line in the file. You can include any or all of the area qualifiers in the options file. (See the format section for the list of Area qualifiers.) You can use the DCL line continuation character, a hyphen (-), or the comment character (!) in the options file. The default file extension is .opt.

Page_Buffers=number-buffers

Specifies the maximum number of buffers Oracle Rdb uses during the RMU Restore operation while the database files are being created. The value of the Page_Buffers qualifier can range from 1 to 5. The default is 3 buffers. Values larger than 3 might improve performance, especially during incremental restore operations.

1.42 RMU Restore Command

When RMU Restore enters the stage of reconstructing internal structures at the end of the restore operation, a high value for the Page_Buffers qualifier can be useful for very large databases. However, the cost of using these extra buffers is that memory use is high. Thus, the trade-off during a restore operation is memory use against performance.

Path=cdd-path

Specifies a data dictionary path into which the database definitions be integrated. If you do not specify the Path qualifier, RMU Restore uses the CDD\$DEFAULT logical name value of the user who entered the RMU Restore command.

If you specify a relative path name, Oracle Rdb appends the *relative* path name you enter to the CDD\$DEFAULT value. If the cdd-path parameter contains nonalphanumeric characters, you must enclose it within quotation marks (" ").

Oracle Rdb ignores the Path qualifier if you use the Nocdd_Integrate qualifier or if the data dictionary is not installed on your system.

Prompt=Automatic

Prompt=Operator

Prompt=Client

Specifies where server prompts are to be sent. When you specify Prompt=Automatic, prompts are sent to the standard input device, and when you specify Prompt=Operator, prompts are sent to the server console. When you specify Prompt=Client, prompts are sent to the client system.

Recovery[=Aij_Buffers=n]

Norecovery

The Recovery=Aij_Buffers=n qualifier allows you to specify the number of recovery buffers to use during an automatic recovery. The default value of *n* is 100 recovery buffers.

The Recovery qualifier explicitly specifies that RMU Restore should attempt an automatic recovery of the .ajj files during the restore operation.

Specify either the Recover=Aij_Buffers=n qualifier and the Recovery qualifier only if .ajj files are being retained. If you specify either qualifier in a situation where .ajj files are not retained (the Aij_Options, After_Journal, or Duplicate qualifier has been specified), a warning message is displayed and RMU Restore performs the restore operation without attempting to recover the .ajj files.

The Norecovery qualifier specifies that RMU Restore should not attempt an automatic recovery of the .ajj files during the restore operation. Specify this qualifier if you want to use the RMU Recover command with the Until qualifier or if you intend to perform an incremental restore operation.

1.42 RMU Restore Command

Rewind

Norewind

Specifies that the tape that contains the backup file will be rewound before processing begins. The Norewind qualifier, the default, causes the search for the backup file to begin at the current tape position.

The Rewind and Norewind qualifiers are applicable only to tape devices. RMU Restore returns an error message if you use these qualifiers and the target device is not a tape device.

Root=root-file-spec

Specifies the database root (.rdb) file specification of the restored database. See the Usage Notes for information on how this qualifier interacts with the Directory, File, and Snapshot qualifiers and for warnings regarding restoring database files into a directory owned by a resource identifier.

The Root qualifier is only meaningful when used with a multifile database.

Transaction_Mode=(mode-list)

Sets the allowable transaction modes for the database root file restored by the restore operation. The primary use of this qualifier is when you restore a backup file (of a master database) to create a Hot Standby database. Because only read-only transactions are allowed on a standby database, you should use the Transaction_Mode=Read_Only qualifier setting. This setting prevents modifications to the standby database at all times, even when replication operations are not active. For more information on Hot Standby see the *Oracle Rdb7 and Oracle CODASYL DBMS: Guide to Hot Standby Databases*. The mode-list can include one or more of the following transaction modes:

- All - Enables all transaction modes
- Current - Enables all transaction modes that are set for the source database. This is the default transaction mode.
- None - Disables all transaction modes
- [No]Batch_Update
- [No]Read_Only
- [No]Exclusive
- [No]Exclusive_Read
- [No]Exclusive_Write
- [No]Protected
- [No]Protected_Read

1.42 RMU Restore Command

- [No]Protected_Write
- [No]Read_Write
- [No]Shared
- [No]Shared_Read
- [No]Shared_Write

Your restore operation must include the database root file. Otherwise, RMU Restore returns the CONFLSWIT error when you issue an RMU Restore command with the Transaction_Mode qualifier.

If you specify more than one transaction mode in the mode-list, enclose the list in parenthesis and separate the transaction modes from one another with a comma. Note the following:

- When you specify a negated transaction mode, it indicates that a mode is not an allowable access mode. For example, if you specify the Noexclusive_Write access mode, it indicates that exclusive write is not an allowable access mode for the restored database.
- If you specify the Shared, Exclusive, or Protected transaction mode, Oracle RMU assumes you are referring to both reading and writing in that transaction mode.
- No mode is enabled unless you add that mode to the list, or you use the All option to enable all transaction modes.
- You can list one transaction mode that enables or disables a particular mode followed by another that does the opposite.

For example, Transaction_Mode=(Noshared_Write, Shared) is ambiguous because the first value disables Shared_Write access and the second value enables Shared_Write access. Oracle RMU resolves the ambiguity by first enabling the modes as specified in the modes-list and then disabling the modes as specified in the modes-list. The order of items in the list is irrelevant. In the example presented previously, Shared_Read is enabled and Shared_Write is disabled.

Users_Max=number-users

Specifies a new upper limit on the number of users that can simultaneously access the restored database. The valid range is between 1 and 2032 users. The default value is the value defined for the database before it was backed up.

You cannot specify the Users_Max qualifier if you use the Incremental qualifier or the Area qualifier.

1.42 RMU Restore Command

Volumes=n

Allows you to specify that concurrent tape access is to be used to accelerate the restore operation.

The Volumes qualifier indicates concurrent tape access and specifies the number of tape volumes in the backup file. The number of volumes must be specified accurately for the restore operation to complete.

If you are restoring from a multidisk backup file, the value of "n" indicates the number of disk devices containing backup files needed for the restore operation.

If you do not specify the Volumes qualifier, the restore operation does not use concurrent tape access.

File or Area Qualifiers

Blocks_Per_Page=integer

Lets you restore a database with larger mixed page sizes than existed in the original database. This creates new free space on each page in the storage area file and does not interfere with record clustering. RMU Restore ignores this qualifier when it specifies an integer less than or equal to the current page size of the area.

You might want to increase the page size in storage areas containing hash indexes that are close to full. By increasing the page size in such a situation, you prevent the storage area from extending.

You cannot use this qualifier to change the page size of a storage area with a uniform page format.

Extension=Disable

Extension=Enable

Allows you to change the automatic file extension attribute when you restore a database. These qualifiers are positional qualifiers.

Use the Extension=Disable qualifier to disable automatic file extension for a storage area.

Use the Extension=Enable qualifier to enable automatic file extension for a storage area.

If you do not specify the Extension=Disable or Extension=Enable qualifier, the storage areas are restored with the automatic file extension attributes that were in effect when the database was backed up.

File=file-spec

Requests that the storage area to which this qualifier is applied be restored in the specified location.

1.42 RMU Restore Command

This qualifier is not valid for single-file databases. This is a positional qualifier.

See the Usage Notes for information on how this qualifier interacts with the Root, Directory, and Snapshot qualifiers and for warnings regarding restoring database files into a directory owned by a resource identifier.

Just_Corrupt

This qualifier replaces the Just_Pages qualifier beginning in Oracle Rdb V7.0.

Allows you to restore the corrupt pages and areas in the database as recorded in the corrupt page table (CPT). The CPT is maintained in the .rdb file. (Note that if the corrupt page table becomes full, the area with the highest number of corrupt pages is marked corrupt and the individual pages for that area are removed from the CPT.)

Often, only one or a few pages in the database are corrupted due to hardware or software faults. The Just_Corrupt qualifier allows you to recover that database in minimal time with minimal interference; availability of the uncorrupted data is unaffected. It allows you to restrict the restoration to the pages (or areas) logged as corrupt in the corrupt page table.

The Just_Corrupt qualifier is a positional qualifier. If you use it in the global position, RMU Restore restores all the corrupt pages and all the corrupt areas as logged in the corrupt page table. If you use it in the local position, RMU Restore restores only the corrupt pages (or the entire area) of the area name it modifies.

It is possible to mix restoration of complete areas and just corrupt pages in the same command. The following example restores all of AREA_1 (regardless of whether or not it is corrupt), but just the corrupt pages (logged to the CPT) in AREA_2.

```
$ RMU/RESTORE/AREA backup_file AREA_1, AREA_2/JUST_CORRUPT
```

Note that when the Just_Corrupt qualifier is used globally, all the corrupt pages logged to the CPT for the areas specified are restored. For example, the following command restores all the corrupt pages logged to the CPT for AREA_1 and AREA_2. (However, if one of the areas specified contains no corruptions, an informational message is displayed and that area is not restored.)

```
$ RMU/RESTORE/JUST_CORRUPT backup_file /AREA AREA_1, AREA_2
```

Restoration of corrupt pages and area can be performed on line. Online operations lock only the corrupt pages or areas for the duration of the restore operation. The remainder of the storage area can be read or updated by an application. When an entire area is restored on line, applications are locked out of the entire area for the duration of the restore operation.

1.42 RMU Restore Command

There are some restrictions on the use of the `Just_Corrupt` qualifier:

- The backup file must be a full backup file that contains the selected area.
- When space area management (SPAM) pages are restored, RMU Restore rebuilds the SPAM page using information from the range of data pages that the SPAM page manages.
- Area bit map (ABM) pages can be restored, but their content is not reconstructed. If ABM pages have been corrupted, regenerate them with the RMU Repair command.
- A by-page restore operation is like a by-area restore operation in that after-image journal (AIJ) recovery is required to make the restored data consistent with the rest of the database.

Once the pages are restored, access to these restored pages is prohibited until they are made consistent. Inconsistent pages are stored in the corrupt page table (CPT) and have their timestamp field flagged by Oracle Rdb.

- You can also use the `Just_Corrupt` qualifier in a restore options file. However, you cannot use any of the following qualifiers with the `Just_Corrupt` qualifier (neither within an options file nor on the command line):
 - `Blocks_Per_Page`
 - `Extension`
 - `File`
 - `Incremental`
 - `Read_Only`
 - `Read_Write`
 - `Snapshot`
 - `Spams`
 - `Thresholds`

You can use the `Just_Corrupt` qualifier in conjunction with the `Journal=file` qualifier to greatly speed up processing of a large tape backup file. When you use the `Journal` qualifier, only those tapes containing corrupt pages, areas, or both, are mounted and processed.

Just_Pages[=(p1,p2,...)]

This qualifier is replaced with the `Just_Corrupt` qualifier beginning in Oracle Rdb V7.0. See the description of the `Just_Corrupt` qualifier.

1.42 RMU Restore Command

Read_Only

Use the `Read_Only` qualifier to change a read/write storage area or a write-once storage area to a read-only storage area.

If you do not specify the `Read_Only` or the `Read_Write` qualifier, the storage areas are restored with the read/write attributes that were in effect when the database was backed up.

This is a positional qualifier.

Read_Write

Use the `Read_Write` qualifier to change a read-only storage area or a write-once storage area to a read/write storage area.

If you do not specify the `Read_Only` or the `Read_Write` qualifier, the storage areas are restored with the read/write attributes that were in effect when the database was backed up.

This is a positional qualifier.

Snapshot=(Allocation=n,File=file-spec)

If you specify the `Allocation` parameter, specifies the snapshot file allocation size in *n* pages for a restored area. If you specify the `File` parameter, specifies a new snapshot file location for the restored storage area to which it is applied. You can specify the `Allocation` parameter only, the `File` parameter only, or both parameters; however, if you specify the `Snapshots` qualifier, you must specify at least one parameter.

See the Usage Notes for information on how this qualifier interacts with the `Root`, `File`, and `Directory` qualifiers.

To save read/write disk space, you can specify that less space be allocated for the storage area's `.snp` file when it remains as a read/write file on a read/write disk. If the keyword `Allocation` is omitted, the original allocation is used. The `Snapshot` qualifier is a positional qualifier. This qualifier is not valid for single-file databases.

You cannot specify an `.snp` file name for a single-file database. When you create an `.snp` file for a single-file database, Oracle Rdb does not store the file specification of the `.snp` file. Instead, it uses the file specification of the database root (`.rdb`) file to determine the file specification of the `.snp` file.

If you want to place the `.snp` file on a different device or directory, Oracle Corporation recommends that you create a multifile database. However, you can work around the restriction by defining a search list for a concealed logical name. (However, do not use a nonconcealed rooted logical name to define database files; a database created with a non-concealed rooted logical name can

1.42 RMU Restore Command

be backed up, but may not restore correctly when you attempt to restore the files to a new directory.)

To create a database with an .snp file on a different device or directory, define a search list by using a concealed logical name. Specify the location of the root file as the first item in the search list. When you create the database, use the logical name for the directory specification. Then, copy the .snp file to the second device. The following example demonstrates the workaround:

```
$ ! Define a concealed logical name.
$ DEFINE /TRANS=CONCEALED/SYSTEM TESTDB USER$DISK1:[DATABASE], -
_ $ USER$DISK2:[SNAPSHOT]
$
$ SQL
SQL> -- Create the database.
SQL> --
SQL> CREATE DATABASE FILENAME TESTDB:TEST;
SQL> EXIT
$ !
$ ! Copy the snapshot (.snp) file to the second disk.
$ COPY USER$DISK1:[DATABASE]TEST.SNP -
_ $ USER$DISK2:[SNAPSHOT]TEST.SNP
$ !
$ ! Delete the snapshot (.snp) file from the original disk.
$ DELETE USER$DISK1:[DATABASE]TEST.SNP;
```

Spams

Nospams

Enables the space area management (SPAM) pages for the specified area. The Nospams qualifier disables the SPAM pages for the specified area. The default is to leave the attribute unchanged. The Spams and Nospams qualifiers are not allowed for a storage area that has a uniform page format. This is a positional qualifier.

Thresholds=(val1[,val2[,val3]])

Specifies a storage area's fullness percentage threshold. You can adjust SPAM thresholds to improve future space utilization in the storage area. Each threshold value represents a percentage of fullness on a data page. When a data page reaches the percentage of fullness defined by a given threshold value, the space management entry for the data page is updated to contain that threshold value.

The Thresholds qualifier applies only to storage areas with a mixed page format.

If you do not use the Thresholds qualifier with the RMU Restore command, Oracle Rdb uses the storage area's original thresholds.

1.42 RMU Restore Command

This is a positional qualifier.

See the *Oracle Rdb7 Guide to Database Performance and Tuning* for more information on setting SPAM thresholds.

Usage Notes

- To use the RMU Restore command for a database, you must have the RMU\$RESTORE privilege in the root file access control list (ACL) for the database or the OpenVMS SYSPRV or BYPASS privilege.
- The RMU Restore command provides four qualifiers, Directory, Root, File, and Snapshots, that allow you to specify the target for the restored files. The **target** can be just a directory, just a file name, or a directory and file name.

If you use all or some of these four qualifiers, apply them as follows:

- Use the Root qualifier to indicate the target for the restored database root file.
- Use local application of the File qualifier to specify the target for the restored storage area or areas.
- Use local application of the Snapshots qualifier to specify the target for the restored snapshot file or files.
- Use the Directory qualifier to specify a default target directory. The default target directory is the directory to which all files not qualified with the Root, File, or Snapshot qualifier are restored. It is also the default directory for files qualified with the Root, File, or Snapshot qualifier if the target for these qualifiers does not include a directory specification.

Note the following when using these qualifiers:

- Global application of the File qualifier when the target specification includes a file name causes RMU Restore to restore all of the storage areas to different versions of the same file name. This creates a database that is difficult to manage.
- Global application of the Snapshot qualifier when the target specification includes a file name causes RMU Restore to restore all of the snapshot files to different versions of the same file name. This creates a database that is difficult to manage.

1.42 RMU Restore Command

- Specifying a file name or extension with the Directory qualifier is permitted, but causes RMU Restore to restore all of the files (except those specified with the File or Root qualifier) to different versions of the same file name. Again, this creates a database that is difficult to manage.

See Example 17.

- When you restore a database into a directory owned by a resource identifier, the ACE for the directory is applied to the database root file ACL first, and then the Oracle RMU ACE is added. This method is employed to prevent database users from overriding OpenVMS file security. However, this can result in a database which you consider yours, but to which you have no Oracle RMU privileges to access. See the *Oracle Rdb Guide to Database Maintenance* for details.
- If a backup file to tape is created using a single tape device, it must be restored using a single tape device; it cannot be restored using multiple tape devices.

Note

An incremental backup file created for a database running under one version of Oracle Rdb cannot be applied if that database has been restored under another version of Oracle Rdb. For example, if you do the following, step 6 fails with the error message, “XVERREST, Cross version RESTORE is not possible for by-area or incremental functions”:

1. Apply a full backup operation to a Version 7.1 database.
2. Apply updates to the database.
3. Perform an incremental backup operation on the database.
4. Move backup files to a system running Oracle Rdb Version 7.2.
5. Restore the database by using the full backup file.
6. Attempt to apply the incremental backup file created in step 1.

-
- If you apply an incremental backup file, you must specify the Norecovery qualifier when you issue a full RMU Restore command for the corresponding full backup file.

1.42 RMU Restore Command

- If you mistakenly attempt to restore a backup file in a version of Oracle Rdb that is earlier than the version for which the backup file was created, you might receive INVRECTYP errors and your operation will probably terminate with an access violation (ACCVIO) exception. If you receive this error, check the version of the backup file and the version of Oracle Rdb you are running. Be sure the environment version matches, or is greater than, the version under which the backup file was created.
- RMU Restore might create an .rdb file and .rda files when it starts up. If you specify the Log qualifier, these files will be noted in the log file. These are *not* database files until the end of the operation when they have been populated with the backed-up contents. Therefore, if the restore operation aborts or is stopped using Ctrl/Y, you must delete these unpopulated files by using the DCL DELETE command. You know which files to delete by the contents of the backup file and the form of the command issued, or by examining the output in the log file if you specified the Log qualifier. Deleting the files usually requires OpenVMS privileges. Until they are restored, these files are not a database, and Oracle RMU or SQL operations do not function with them.
- RMU Restore preserves any area reservations and after-image journal (.aij) file reservations that exist in the backed-up database.
- If you restore a database without its root file ACL (using the Noacl qualifier with the RMU Restore command, for example), a user who wants to create ACL entries for the database must have the OpenVMS SECURITY or BYPASS privilege.
- The RMU Restore command with the Area and Online qualifiers requires exclusive access to the area files being restored. The RMU Restore command with the Area, Online, and Just_Corrupt qualifiers requires exclusive access to only the pages being restored.
- There are no restrictions on the use of the Nospams qualifier with storage areas that have a mixed page format, but the use of the Nospams qualifier typically causes severe performance degradation. The Nospams qualifier is useful only where updates are rare and batched, and access is primarily by database key (dbkey).
- The RMU Restore command automatically uses the RMU Convert command when restoring the database to a system with a more recent version of Oracle Rdb software. When this is done, the metadata in the Oracle Rdb database changes and invalidates incremental backup files from the previous version. By default, no areas are reserved and one .aij file is reserved. (You can override the after-image journal default reservation by

1.42 RMU Restore Command

using the `Aij_Options` qualifier.) See Section 1.16 for information on the versions of Oracle Rdb that the `Convert` command supports.

- Always back up your Oracle Rdb databases as recommended in the *Oracle Rdb Installation and Configuration Guide* just prior to installing a newer version of Oracle Rdb software. The last backup file made prior to converting to a more recent version of Oracle Rdb should be a full and complete backup file.
- See the *Oracle Rdb Guide to Database Maintenance* for information on the steps `RMU Restore` follows in tape label checking when you restore a database from tape.
- `RMU Restore` might initialize the SPAM thresholds for some data pages of some storage areas that have a uniform page format to values that are not acceptable to the `RMU Verify` command. This occurs when some of the data pages in a logical area are restored before the logical area definition (Area Inventory). This is not a frequent occurrence, and when it does happen, the consequences are usually cosmetic (the `RMU Verify` command issues a warning message for each page affected). However, if many pages are affected, the volume of warnings can cause you to overlook a real problem. Moreover, in some cases, this can result in additional I/O operations when new data is stored in an affected table.

As a workaround, you can use the `RMU Repair` command to reconstruct the SPAM pages in one or more storage areas. The `RMU Repair` command corrects the condition caused by the `RMU Restore` command as well as other SPAM page corruptions. See Section 1.40 for more information on the `RMU Repair` command.

Examples

Example 1

The following example restores the `mf_personnel` database from the backup file `pers_bu.rbf` and requests a new version of the database file. Because the `After_Journal` qualifier has been specified, automatic recovery will not be attempted.

```
$ RMU/RESTORE/NEW_VERSION/AFTER_JOURNAL=AIJ_DISK:[AIJS]PERSAIJ -
_ $ /NOCDD_INTEGRATE/LOG PERS_BU -
_ $ EMP_INFO /THRESHOLDS=(65,75,80)/BLOCKS_PER_PAGE=3
```

1.42 RMU Restore Command

The command changes the .ajj file location and name to AIJ_DISK:[AIJS]PERSAIJ.AIJ, prevents integration with the data dictionary, and displays the progress of the restore operation. For the storage area, EMP_INFO, the command changes the SPAM threshold values to 65%, 75%, and 80%, and increases the number of blocks per page to 3 blocks.

Example 2

Assume that at 10 A.M., Wednesday, October 25, 2005, a disk device hardware failure corrupted all the files on the device, including the mf_personnel.rdb file. The following command restores the full database backup file (pers_full_oct22.rbf) created on the previous Sunday and then restores the incremental backup file made on Tuesday. Note that an incremental database backup file was created on Monday, but each new incremental backup file made since the latest full backup file replaces previous incremental backup files made since the last full backup operation.

```
$ RMU/RESTORE/LOG/NORECOVERY MUA1:PERS_FULL_OCT22.RBF
$ RMU/RESTORE/INCREMENTAL/CONFIRM/LOG/NORECOVERY -
_$ PERS_INCR_OCT24.RBF
```

At this point, the database is current up until 11:30 P.M., Tuesday, when the last incremental backup file was made of mf_personnel. Because after-image journaling is enabled for this database, automatic recovery of the .ajj file could have been employed. However, if the recovery process should fail for some reason or, as in this case, the Norecovery qualifier is specified, you can still use the RMU Recover command to apply the .ajj file that contains changes made to the database from 11:30 P.M., Tuesday, until just before the hardware failure to the restored mf_personnel.rdb file and its storage area files. For example:

```
$ RMU/RECOVER/UNTIL = "25-OCT-2005 09:55:00.00" -
_$ AIJ_DISK:[AIJS]PERSAIJ.AIJ;1
```

Example 3

If a storage area is on a disk that fails, you might want to move that storage area to another disk by using the RMU Restore command. The following RMU Restore command restores only the EMPIDS_OVER storage area from the full backup file of mf_personnel, and moves the EMPIDS_OVER storage area and snapshot (.snp) file to a new location on the 333\$DUA11 disk. The recovery operation is only required if the required .ajj file has been backed up and is no longer in the current ajj state.

1.42 RMU Restore Command

```
$ RMU/RESTORE/AREA 222$DUA20:[BACKUPS]MF_PERS_BU.RBF -
_ $ EMPIDS_OVER /FILE=333$DUA11:[DBS]EMPIDS_OVER.RDA -
_ $ /SNAPSHOT=(FILE=333$DUA11:[DBS]EMPIDS_OVER.SNP)
$ !
$ ! Recovery from the after-image journal is automatic. If
$ ! automatic recovery is not possible, or if the Norecovery
$ ! qualifier had been specified, perform the following:
$ !
$ RMU/RECOVER/AREA AIJ_DISK:PERS.AIJ
```

Example 4

The following example demonstrates how you can use by-area backup and restore operations for a single storage area in the `mf_personnel` database. In addition, it demonstrates the use of the automatic recovery feature of the RMU Restore command.

```
$ !
$ ! Create an .aij file for the database. Because three
$ ! .aij files are created, fixed-size .aij
$ ! journaling will be used.
$ !
$ RMU/SET AFTER_JOURNAL/ENABLE/RESERVE=4 -
_ $ /ADD=(name=AIJ1, FILE=DISK2:[CORP]AIJ_ONE) -
_ $ /ADD=(name=AIJ2, FILE=DISK2:[CORP]AIJ_TWO) -
_ $ /ADD=(NAME=AIJ3, FILE=DISK2:[CORP]AIJ_THREE) -
_ $ MF_PERSONNEL.RDB
%RMU-W-DOFULLBCK, full database backup should be done to
ensure future recovery
$ RMU/BACKUP MF_PERSONNEL DISK3:[BACKUP]MF_PERS.RBF

$ SQL
SQL> ATTACH 'FILENAME MF_PERSONNEL';

SQL> --
SQL> -- On Monday, define a new row in the DEPARTMENTS table. The
SQL> -- new row is stored in the DEPARTMENTS storage area.
SQL> --
SQL> INSERT INTO DEPARTMENTS
cont> (DEPARTMENT_CODE, DEPARTMENT_NAME, MANAGER_ID,
cont> BUDGET_PROJECTED, BUDGET_ACTUAL)
cont> VALUES ('WLNS', 'Wellness Center', '00188', 0, 0);
1 row inserted
SQL>

SQL> COMMIT;
SQL> EXIT;
```

1.42 RMU Restore Command

```
$ !
$ ! Assume that you know that the only storage area ever updated in
$ ! the mf_personnel database on Tuesdays is the SALARY_HISTORY
$ ! storage area, and you decide that you will create an incremental
$ ! backup file of just the SALARY_HISTORY storage area on Tuesday.
$ ! Before you perform the by-area backup operation on the
$ ! SALARY_HISTORY storage area on Tuesday, you must perform a full
$ ! and complete backup operation on the mf_personnel database when
$ ! it is in a known and working state.
$ !

$ RMU/BACKUP MF_PERSONNEL.RDB -
_$ DISK3:[BACKUP]MF_MONDAY_FULL.RBF
$ !

SQL> --
SQL> -- On Tuesday, two rows are updated in
SQL> -- the SALARY_HISTORY storage area.
SQL> --
SQL> UPDATE SALARY_HISTORY
cont>   SET SALARY_END ='20-JUL-2003 00:00:00.00'
cont>   WHERE SALARY_START='14-JAN-1993 00:00:00.00'
cont>   AND EMPLOYEE_ID = '00164';
1 row updated
SQL> UPDATE SALARY_HISTORY
cont>   SET SALARY_START ='5-JUL-2000 00:00:00.00'
cont>   WHERE SALARY_START='5-JUL-1990 00:00:00.00'
cont>   AND EMPLOYEE_ID = '00164';
1 row updated

SQL> COMMIT;
SQL> EXIT;

$ !
$ ! On Tuesday, you create an incremental backup file of the
$ ! SALARY_HISTORY storage area only. Only the SALARY_HISTORY
$ ! storage area is included in the by-area backup file.
$ ! Oracle RMU provides an informational message telling
$ ! you that not all storage areas in the database are included
$ ! in the mf_tuesday_partial.rbf backup file.
```

1.42 RMU Restore Command

```
$ RMU/BACKUP/INCLUDE=(SALARY_HISTORY) -
_ $ /INCREMENTAL/LOG DISK1:[USER]MF_PERSONNEL.RDB -
_ $ DISK3:[BACKUPS]MF_TUESDAY_PARTIAL.RBF
%RMU-I-NOTALLARE, Not all areas will be included in
  this backup file
%RMU-I-LOGLASCOM, Last full and complete backup was dated
  18-JAN-2006 11:19:46.31
%RMU-I-BCKTXT_00, Backed up root file
  DISK1:[DB]MF_PERSONNEL.RDB;1
%RMU-I-BCKTXT_03, Starting incremental backup of
  storage area DISK3:[SA]SALARY_HISTORY.RDA;1 at
  18-JAN-2006 11:20:49.29
%RMU-I-BCKTXT_13, Completed incremental backup of
  storage area DISK3:[SA]SALARY_HISTORY.RDA;1 at
  18-JAN-2006 11:20:49.40
%RMU-I-COMPLETED, BACKUP operation completed at
  18-JAN-2006 11:20:49.59
.
.
.
$ !

SQL> -- Update another row in the SALARY_HISTORY table:
SQL> UPDATE SALARY_HISTORY
cont>   SET SALARY_START = '23-SEP-1991 00:00:00.00'
cont>   WHERE SALARY_START = '21-SEP-1981 00:00:00.00'
cont>   AND EMPLOYEE_ID = '00164';
1 row updated
SQL> COMMIT;
SQL> EXIT;

$ ! Assume that a disk device hardware error occurs here
$ ! and only the SALARY_HISTORY storage area and snapshot
$ ! file is lost. Also assume that the database root (.rdb)
$ ! file and other storage areas in the database are still
$ ! fine and do not need to be restored or recovered.
$ ! Therefore, you do not need to restore the .rdb file or
$ ! other storage areas from the full and complete backup
$ ! file. Because only the SALARY_HISTORY storage area was
$ ! lost, you must do the following:
$ ! 1) Restore the SALARY_HISTORY storage area and snapshot
$ !    file from the last full and complete backup file. Note
$ !    this operation can be done on line. Specify the Norecovery
$ !    qualifier because you still have an incremental restore
$ !    operation to perform.
$ ! 2) Restore the SALARY_HISTORY storage area from the last
$ !    incremental backup file. Note this operation can be
$ !    done on line. This time do not specify the Norecovery
$ !    qualifier so that the automatic recovery provided by
$ !    Oracle RMU will be implemented.
$ !
```

1.42 RMU Restore Command

```
$ RMU/RESTORE/NOCCD_INTEGRATE/ONLINE/LOG/NORECOVERY -
_$ /AREA DISK3:[BACKUP]MF_MONDAY_FULL.RBF SALARY_HISTORY
%RMU-I-REXTXT_21, Starting full restore of storage area
  DISK1:[USER]SALARY_HISTORY.RDA;1 at 18-JAN-2006 11:25:13.17
%RMU-I-REXTXT_24, Completed full restore of storage area
  DISK1:[USER]SALARY_HISTORY.RDA;1 at 18-JAN-2006 11:25:13.86
%RMU-I-REXTXT_01, Initialized snapshot file
  DISK1:[USER]SALARY_HISTORY.SNP;1
%RMU-I-LOGINIFIL,      contains 100 pages, each page is 2
  blocks long
%RMU-I-AIJWASON, AIJ journaling was active when the database
  was backed up
%RMU-I-AIJRECFUL, Recovery of the entire database starts with
  AIJ file sequence 0
%RMU-I-AIJRECARE, Recovery of area SALARY_HISTORY starts with
  AIJ file sequence 0
%RMU-I-COMPLETED, RESTORE operation completed at 18-JAN-2006 11:25:14.51

$ RMU/RESTORE/NOCCD_INTEGRATE/INCREMENTAL/ONLINE/LOG -
_$ /AREA DISK3:[BACKUPS]MF_TUESDAY_PARTIAL.RBF SALARY_HISTORY
DISK1:[USER]MF_PERSONNEL.RDB;1, restore incrementally? [N]:Y
%RMU-I-REXTXT_22, Starting incremental restore of storage area
  DISK1:[USER]SALARY_HISTORY.RDA;1 at 18-JAN-2006 11:29:35.54
%RMU-I-REXTXT_25, Completed incremental restore of storage area
  DISK1:[USER]SALARY_HISTORY.RDA;1 at 18-JAN-2006 11:29:35.64
%RMU-I-REXTXT_01, Initialized snapshot file
  DISK1:[USER]SALARY_HISTORY.SNP;1
%RMU-I-LOGINIFIL,      contains 100 pages, each page is 2
  blocks long
%RMU-I-AIJWASON, AIJ journaling was active when the database
  was backed up
%RMU-I-AIJRECFUL, Recovery of the entire database starts with
  AIJ file sequence 0
%RMU-I-AIJRECARE, Recovery of area SALARY_HISTORY starts with
  AIJ file sequence 0
%RMU-I-AIJBADAREA, inconsistent storage area
  DISK1:[USER]SALARY_HISTORY.RDA;1 needs AIJ sequence number 0
%RMU-I-LOGRECDB, recovering database file
  DISK1:[USER]MF_PERSONNEL.RDB;1
%RMU-I-AIJAUTOREC, starting automatic after-image journal recovery
%RMU-I-LOGOPNAIJ, opened journal file DISK2:[CORP]AIJ_ONE.AIJ;17
%RMU-I-AIJONEDONE, AIJ file sequence 0 roll-forward operations completed
%RMU-I-LOGRECOVR, 1 transaction committed
%RMU-I-LOGRECOVR, 0 transactions rolled back
%RMU-I-LOGRECOVR, 3 transactions ignored
%RMU-I-AIJNOACTIVE, there are no active transactions
%RMU-I-AIJSUCCEC, database recovery completed successfully
%RMU-I-AIJALDONE, after-image journal roll-forward operations completed
%RMU-I-LOGSUMMARY, total 1 transaction committed
%RMU-I-LOGSUMMARY, total 0 transactions rolled back
%RMU-I-LOGSUMMARY, total 3 transactions ignored
%RMU-I-AIJSUCCEC, database recovery completed successfully
```

1.42 RMU Restore Command

Example 5

In the following example, the options file specifies that the storage area (.rda) files are to be restored to different disks. Note that storage area snapshot (.snp) files are restored to different disks from one another and from their associated storage area (.rda) files; this is recommended for optimal performance. (This example assumes that the disks specified for each storage area file in options_file.opt are different from those where the storage area files currently reside.)

```
$ RMU/RESTORE/NOCCD_INTEGRATE/OPTIONS=OPTIONS_FILE.OPT -
_ $ MF_PERS_BCK.RBF
$ TYPE OPTIONS_FILE.OPT
EMPIDS_LOW /FILE=DISK1:[CORPORATE.PERSONNEL]EMPIDS_LOW.RDA -
/SNAPSHOT=(FILE=DISK2:[CORPORATE.PERSONNEL]EMPIDS_LOW.SNP )
EMPIDS_MID /FILE=DISK3:[CORPORATE.PERSONNEL]EMPIDS_MID.RDA -
/SNAPSHOT=(FILE=DISK4:[CORPORATE.PERSONNEL]EMPIDS_MID.SNP )
EMPIDS_OVER /FILE=DISK5:[CORPORATE.PERSONNEL]EMPIDS_OVER.RDA -
/SNAPSHOT=(FILE=DISK6:[CORPORATE.PERSONNEL]EMPIDS_OVER.SNP )
DEPARTMENTS /FILE=DISK7:[CORPORATE.PERSONNEL]DEPARTMENTS.RDA -
/SNAPSHOT=(FILE=DISK8:[CORPORATE.PERSONNEL]DEPARTMENTS.SNP )
SALARY_HISTORY /FILE=DISK9:[CORPORATE.PERSONNEL]SALARY_HISTORY.RDA -
/SNAPSHOT=(FILE=DISK10:[CORPORATE.PERSONNEL]SALARY_HISTORY.SNP )
JOBS /FILE=DISK7:[CORPORATE.PERSONNEL]JOBS.RDA -
/SNAPSHOT=(FILE=DISK8:[CORPORATE.PERSONNEL]JOBS.SNP )
EMP_INFO /FILE=DISK9:[CORPORATE.PERSONNEL]EMP_INFO.RDA -
/SNAPSHOT=(FILE=DISK10:[CORPORATE.PERSONNEL]EMP_INFO.SNP )
RESUME_LISTS /FILE=DISK11:[CORPORATE.PERSONNEL]RESUME_LISTS.RDA -
/SNAPSHOT=(FILE=DISK12:[CORPORATE.PERSONNEL]RESUME_LISTS.SNP )
RESUMES /FILE=DISK9:[CORPORATE.PERSONNEL]RESUMES.RDA -
/SNAPSHOT=(FILE=DISK10:[CORPORATE.PERSONNEL]RESUMES.SNP )
```

Example 6

The following example shows what .aij file sequence to use following an RMU Restore command with the Area qualifier if automatic recovery fails:

```
$ RMU/RESTORE/AREA MFPERS_62691.RBF -
DEPARTMENTS, JOBS
.
.
.
%RMU-I-AIJWASON, AIJ journaling was active when the
database was backed up
%RMU-I-AIJRECFUL, Recovery of the entire database
starts with AIJ file sequence 0
```

1.42 RMU Restore Command

Example 7

The following example shows how to move a single-file database to a new directory, using the RMU Backup and RMU Restore commands:

```
$ RMU/BACKUP PERSONNEL PERS
$!
$ RMU/RESTORE/NOCD/NOAFTER_JOURNAL -
_ $ /DIRECTORY=DISK4:[USER2] PERS
```

Example 8

The following example shows how to rename a single-file database when you move the database by using the RMU Backup and RMU Restore commands:

```
$ RMU/BACKUP PERSONNEL PERS
$!
$ RMU/RESTORE/NOCD/NOAFTER_JOURNAL -
_ $ /DIRECTORY=DISK4:[USER2] TEST_PERSONNEL PERS
```

Example 9

The following example causes the database being restored from the `mf_pers_bck.rbf` backup file to have 60 global buffers, with a limit of 2 buffers for each database user. Because the Enabled option is used, global buffering is in effect for the database immediately after it is restored:

```
$ RMU/RESTORE/NOCD/GLOBAL_BUFFERS=(ENABLED,TOTAL=60,USER_LIMIT=2) -
_ $ MF_PERS_BCK.RBF
```

Example 10

The following command causes the `SALARY_HISTORY` storage area from the database being restored from the `mf_pers_bu.rbf` backup file to be restored as a read-only storage area. None of the other database storage areas are modified as part of this restore operation.

```
$ RMU/RESTORE/NOCD MF_PERS_BU.RBF SALARY_HISTORY /READ_ONLY
```

Example 11

The following example assumes that you are using multiple tape drives to perform a large restore operation. By specifying the `Loader_Synchronization` and `Volumes` qualifiers, this command does not require you to load tapes as each completes. Instead, you can load tapes on a loader or stacker and the RMU restore process will wait until all concurrent tape operations have concluded for one set of tape volumes before assigning the next set of tape volumes. This example assumes that the backup operation used two tape output threads and each thread wrote four tapes.

1.42 RMU Restore Command

This example uses Master qualifiers to indicate that you want the \$111\$MUA0: and \$444\$MUA2: drives to be master drives.

Using this example, you would:

1. Allocate each tape drive.
2. Manually place tapes BACK01 and BACK05 on the \$111\$MUA0: master drive.
3. Manually place tapes BACK02 and BACK06 on the \$333\$MUA2: master drive.
4. Manually place tapes BACK03 and BACK07 on the \$222\$MUA1: slave drive.
5. Manually place tapes BACK04 and BACK08 on the \$444\$MUA3: slave drive.
6. Mount the first volume (BACK01).
7. Perform the restore operation.
8. Dismount the last tape mounted.
9. Deallocate each tape drive.

```
$ ALLOCATE $111$MUA0:
$ ALLOCATE $222$MUA1:
$ ALLOCATE $333$MUA2:
$ ALLOCATE $444$MUA3:
$
$ MOUNT/FOREIGN $111$MUA0:
$
$ RMU/RESTORE/LOG/REWIND/LOADER_SYNCHRONIZATION -
_ $ /LABEL=(BACK01, BACK02, BACK03, BACK04, BACK05, -
_ $ BACK06, BACK07, BACK08) -
_ $ /VOLUMES=8 -
_ $ $111$MUA0:PERS_FULL_MAR30.RBF/MASTER, $222$MUA1: -
_ $ $333$MUA2:/MASTER, $444$MUA3
$
$ DISMOUNT $222$MUA3:
$
$ DEALLOCATE $111$MUA0:
$ DEALLOCATE $222$MUA1:
$ DEALLOCATE $333$MUA2:
$ DEALLOCATE $444$MUA3:
```

1.42 RMU Restore Command

Example 12

The following example demonstrates the automatic .aij recovery mechanism in the RMU Restore command. The example does the following:

- Uses the RMU Set After_Journal command to reserve space for four .aij files, adds three .aij files, and enables after-image journaling
- Performs a backup operation on the database
- Performs database update activity, which will be written to an .aij file
- Determines the database root file is lost
- Restores and recovers the database in one RMU Restore command

```
$ SET DEFAULT DISK1:[USER]
$ !
$ RMU/SET AFTER_JOURNAL/ENABLE/RESERVE=4 -
_$/ADD=(name=AIJ1, FILE=DISK2:[CORP]AIJ_ONE) -
_$/ADD=(name=AIJ2, FILE=DISK2:[CORP]AIJ_TWO) -
_$/ADD=(NAME=AIJ3, FILE=DISK2:[CORP]AIJ_THREE) -
_$/MF_PERSONNEL
%RMU-W-DOFULLBCK, full database backup should be done
to ensure future recovery
$ !
$ ! Back up database, as instructed.
$ !
$ RMU/BACKUP MF_PERSONNEL DISK3:[BACKUPS]MF_PERS.RBF
$ !
$ ! Database update activity occurs.
$ !
```

1.42 RMU Restore Command

```
$!  
$! Database is lost. Issue the RMU Restore command to  
$! restore and recover the database. Because the Norecovery  
$! qualifier is not specified, Oracle RMU will  
$! automatically attempt to recover the database.  
$!  
$ RMU/RESTORE DISK3:[BACKUPS]MF_PERS.RBF/NOCDI_INTEGRATE  
%RMU-I-AIJRSTAVL, 3 after-image journals available for use  
%RMU-I-AIJRSTMOD, 1 after-image journal marked as "modified"  
%RMU-I-AIJISON, after-image journaling has been enabled  
%RMU-W-DOFULLBCK, full database backup should be done  
    to ensure future recovery  
%RMU-I-LOGRECDB, recovering database file  
    DISK1:[USER]MF_PERSONNEL.RDB;1  
%RMU-I-AIJAUOREC, starting automatic after-image  
    journal recovery  
%RMU-I-AIJONEDONE, AIJ file sequence 0 roll-forward  
    operations completed  
%RMU-I-AIJONEDONE, AIJ file sequence 1 roll-forward  
    operations completed  
%RMU-W-NOTRANAPP, no transactions in this journal  
    were applied  
%RMU-I-AIJALDONE, after-image journal roll-forward  
    operations completed  
%RMU-I-AIJSUCCE, database recovery completed successfully  
%RMU-I-AIJFNLSEQ, to start another AIJ file recovery,  
    the sequence number needed will be 1
```

Example 13

The following example demonstrates how to restore and recover all the corrupt pages and areas in the `mf_personnel` database. Assume that the `RMU Show Corrupt_Pages` command shows that the `JOBS` storage area is corrupt and that only page 3 in the `DEPARTMENTS` storage area is corrupt. All the other storage areas are neither corrupt nor inconsistent. Because the `Just_Corrupt` qualifier is specified in the global position, and `mf_personnel.rbf` is a full backup file, the RMU restore process restores all of the `JOBS` storage area and just page 3 in the `DEPARTMENTS` storage area. If after-image journaling is enabled, automatic recovery will be attempted.

```
$ RMU/RESTORE/AREA/JUST_CORRUPT MF_PERSONNEL.RBF
```

Example 14

The following example demonstrates how to restore and recover specific corruptions in the `mf_personnel` database. Like example 12, assume that the `RMU Show Corrupt_Pages` command shows that the `JOBS` storage area is corrupt and that only page 3 in the `DEPARTMENTS` storage area is corrupt. All the other storage areas are neither corrupt nor inconsistent. The backup file, `mf_partial.rbf`, is a by-area backup file containing backups of the `JOBS`,

1.42 RMU Restore Command

DEPARTMENTS, and SALARY_HISTORY storage areas. In this example, the JOBS, DEPARTMENTS, and SALARY_HISTORY areas are specified for restoring. Because the SALARY_HISTORY area contains no corruptions, an informational message is returned. The RMU restore process restores all of the JOBS storage area and just page 3 in the DEPARTMENTS storage area. If after-image journaling is enabled, automatic recovery will be attempted.

```
$ RMU/RESTORE/JUST_CORRUPT/AREA MF_PARTIAL.RBF JOBS, -
_ $ DEPARTMENTS,SALARY_HISTORY
%RMU-I-RESTXT_20, Storage area DISK1:[AREA]SALARY_HISTORY.RDA;1 is not
  corrupt and will not be restored
```

Example 15

The following example demonstrates how to restore and recover specific corruptions in the mf_personnel database along with restoring an area that is not corrupt. Like example 13, assume that the RMU Show Corrupt_Pages command shows that the JOBS storage area is corrupt and that only page 3 in the DEPARTMENTS storage area is corrupt. All the other storage areas are neither corrupt nor inconsistent. The backup file, mf_personnel.rbf, is a full backup file. In this example, the Just_Corrupt qualifier is used locally with the DEPARTMENTS storage area.

The JOBS, DEPARTMENTS, and SALARY_HISTORY areas are specified for restoring. Although the SALARY_HISTORY area contains no corruptions, an informational message is not returned in this case because by specifying the Just_Corrupt qualifier locally with DEPARTMENTS, the Restore command is requesting that the RMU restore process restore the JOBS and SALARY_HISTORY storage areas regardless of corruptions, and the DEPARTMENTS storage area be restored to fix corruptions. The RMU restore process restores all of the JOBS and SALARY_HISTORY storage areas and just page 3 in the DEPARTMENTS storage area. If after-image journaling is enabled, automatic recovery will be attempted.

```
$ RMU/RESTORE/AREA MF_PERSONNEL.RBF JOBS, SALARY_HISTORY, -
_ $ DEPARTMENTS/JUST_CORRUPT
```

Example 16

The following example is the same as example 15, except the Just_Corrupt qualifier is specified locally with the SALARY_HISTORY storage area. Because the SALARY_HISTORY qualifier contains no corruptions, an error message is returned:

```
$ RMU/RESTORE/AREA MF_PERSONNEL.RBF JOBS,SALARY_HISTORY/JUST_CORRUPT, -
_ $ DEPARTMENTS/JUST_CORRUPT
%RMU-I-RESTXT_20, Storage area DISK1:[AREA]SALARY_HISTORY.RDA;1 is
  not corrupt and will not be restored
```

1.42 RMU Restore Command

Example 17

The following example demonstrates the behavior of the RMU Restore command when the `Just_Corrupt` qualifier is used both globally and locally. The global use of the `Just_Corrupt` qualifier overrides an local use of the qualifier. In this case, the RMU restore process restores the `JOBS`, `SALARY_HISTORY`, and `DEPARTMENTS` storage areas only if they contain corruptions; otherwise an error is returned. Assume, like the previous examples, that only the `JOBS` and `DEPARTMENTS` storage areas contain corruptions:

```
$ RMU/RESTORE/JUST_CORRUPT/AREA MF_PERSONNEL.RBF SALARY_HISTORY, -
_ $ JOBS/JUST_CORRUPT, DEPARTMENTS/JUST_CORRUPT
%RMU-I-RESTXT_20, Storage area DISK1:[AREA]SALARY_HISTORY.RDA;1 is
not corrupt and will not be restored
```

Example 18

The following example demonstrates the use of the `Directory`, `File`, and `Root` qualifiers. In this example:

- The default directory is specified as `DISK2:[DIR]`.
- The target directory and file name for the database root file is specified with the `Root` qualifier. The target directory specified with the `Root` qualifier overrides the default directory specified with the `Directory` qualifier. Thus, the RMU restore process restores the database root in `DISK3:[ROOT]` and names it `COPYRDB.RDB`.
- The target directory for the `EMPIDS_MID` storage area is `DISK4:[FILE]`. The RMU restore process restores `EMPIDS_MID` in `DISK4:[FILE]`.
- The target file name for the `EMPIDS_LOW` storage area is `EMPIDS`. Thus, the RMU restore process restores the `EMPIDS_LOW` storage area to the `DISK2:[DIR]` default directory (specified with the `Directory` qualifier), and names the file `EMPIDS.RDA`.
- The target for the `EMPIDS_LOW` snapshot file is `DISK5:[SNAP]EMPIDS.SNP`. Thus, the RMU restore process restores the `EMPIDS_LOW` snapshot file to `DISK5:[SNAP]EMPIDS.SNP`.
- All the other storage area files and snapshot files in the `mf_personnel` database are restored in `DISK2:[DIR]`; the file names for these storage areas and snapshot files remain unchanged.

1.42 RMU Restore Command

```
$ RMU/RESTORE MF_PERSONNEL.RBF -
_ $ /DIRECTORY=DISK2:[DIR] -
_ $ /ROOT=DISK3:[ROOT]MF_PERSONNEL.RDB -
_ $ EMPIDS_MID/FILE=DISK4:[FILE], -
_ $ EMPIDS_LOW/FILE=EMPIDS -
_ $ /SNAPSHOT=(FILE=DISK5:[SNAP]EMPIDS.SNP)
```

Example 19

The following example demonstrates how to restore a database such that the newly restored database will allow read-only transactions only. After the RMU restore process executes the command, the database is ready for you to start Hot Standby replication operations. See the *Oracle Rdb7 and Oracle CODASYL DBMS: Guide to Hot Standby Databases* for details on starting Hot Standby replication operations.

```
$RMU/RESTORE/TRANSACTION_MODE=READ_ONLY MF_PERSONNEL.RBF
```

Example 20

The following example uses the Nocommit qualifier while restoring a backup file of a database that has a structure level of V7.1 in a V7.2 environment.

```
$ RMU/SHOW VERSION
Executing RMU for Oracle Rdb V7.2-00
$ RMU/RESTORE MFP71.RBF /NOCOMMIT/NOCDD/NORECOVER
%RMU-I-AIJRSTAVL, 0 after-image journals available for use
%RMU-I-AIJISOFF, after-image journaling has been disabled
%RMU-I-LOGCONVRT, database root converted to current structure level
%RMU-S-CVTDBSUC, database USER1:[80]MF_PERSONNEL.RDB;1 successfully
converted from version V7.1 to V7.2
%RMU-W-USERECCOM, Use the RMU Recover command. The journals are not
available.
$ RMU/SHOW VERSION
Executing RMU for Oracle Rdb V7.2-00
$ RMU/CONVERT/ROLLBACK MF_PERSONNEL.RDB
%RMU-I-RMUTXT_000, Executing RMU for Oracle Rdb V7.2-00
Are you satisfied with your backup of RDBVMS_USER1:[V71]MF_PERSONNEL.RDB;1
and your backup of any associated .aij files [N]? Y
%RMU-I-LOGCONVRT, database root converted to current structure level
%RMU-I-CVTROLSUC, CONVERT rolled-back for RDBVMS_USER1:[V71]MF_PERSONNEL.
RDB;1 to version V7.1
```

Example 21

The following example uses the Close_Wait qualifier to set the database close mode to TIMED AUTOMATIC, specifying that the database will be closed automatically in 10 minutes.

```
$ RMU/RESTORE/OPEN_MODE=AUTOMATIC/CLOSE_WAIT=10/DIR=DISK:[DIR] TEST_DB.RBF
$ RMU/DUMP/HEADER=PARAMETERS TEST_DB.RDB
```

1.43 RMU Restore Only_Root Command

1.43 RMU Restore Only_Root Command

Permits you to recover more quickly from the loss of a database root (.rdb) file by restoring only the root file. This command is not valid for single-file databases.

Format

RMU/Restore/Only_Root backup-file-spec [storage-area-list]

Command Qualifiers

/Active_IO=max-reads
/[No]After_Journal=file-spec
/[No]Aij_Options=journal-opts
/Directory=directory-spec
/[No]Initialize_Tsns
/Label=(label-name-list)
/Librarian[=options]
/[No]Log
/[No]Media_Loader
/[No]New_Snapshots
/Nodes_Max=number-cluster-nodes
/Options=file-spec
/[No]Rewind
/Root=root-file-spec
/[No]Set_Tsn=Tsn=n,Csn=m
/Transaction_Mode=(modes-list)
/[No]Update_Files
/Users_Max=number-users

Defaults

/Active IO=3
See description
See description
See description
/Noinitialize_Tsns
See description
None
Current DCL verify value
See description
/Nonew_Snapshots
Existing value
None
/Norewind
Existing value
See description
/Transaction_Mode=Current
/Update_Files
Existing value

File or Area Qualifiers

/[No]Blocks_Per_Page=integer
/File=file-spec
/Read_Only
/Read_Write
/Snapshot=(Allocation=n,File=file-spec)
/[No]Spams
/Thresholds=(val1[,val2[,val3]])

Defaults

/Noblocks_Per_Page
See description
Current value
Current value
See description
Current value
Existing area file value

1.43 RMU Restore Only_Root Command

Description

The RMU Restore Only_Root command rebuilds only the database root (.rdp) file from a backup file, produced earlier by an RMU Backup command, to the condition the .rdp file was in when the backup operation was performed. Use the command qualifiers to update the .rdp file. The area qualifiers alter only the .rdp file, not the storage areas themselves. Use the area qualifiers to correct the restored backup root file so that it contains storage area information that was updated since the last backup operation was performed on the database. This is useful when you need to match the root from an older backup file of your database with the area information in the more recent backup file of your database in order to have a usable database.

When the .rdp file is restored by itself, be sure that you correctly set the transaction state of the database with the Initialize_Tsns qualifier or the Set_Tsn qualifier. If the database transaction sequence number (TSN) and commit sequence number (CSN) are not set to the same values as those that were in the lost .rdp file, there will be an inconsistency in the journaling if after-image journaling is enabled. Therefore, you cannot recover the database by using journal files created before you used either the Initialize_Tsns qualifier or the Set_Tsn qualifier in a restore-only-root operation.

You should set the TSN to a value equal to or greater than the value that was in the lost .rdp file. If the TSN is set to a lower value than the value stored in the lost database root file, the database is corrupted, and it might return incorrect data or result in application failures. If the number you have selected is less than the Next CSN and Next TSN values, you will receive a fatal error message as follows:

```
%RMU-F-VALLSSMIN, value (0:40) is less than minimum allowed
value (0:74) for Set_Tsn=tsn
```

After the set TSN and reinitialize TSN operations complete, and after you have verified the .rdp file, enabled after-image journaling, and the new .ajj file is created, all .ajj records are based on the new starting TSN and CSN numbers in the .rdp file.

Although Oracle Corporation recommends that your backup strategy ensures that you maintain a current full and complete database backup file, it is possible to restore the database from current full by-area backup files only. This is accomplished by restoring the root and specifying the Noupdate_Files and Noset_Tsn qualifiers. When you specify the Noset_Tsn qualifier, the TSN and CSN values on the restored database will be the same as those recorded in the backup file. When you specify the Noupdate_Files qualifier, the database root is restored but RMU Restore Only_Root will not link that restored root to any of the area files, nor will it create or update the snapshot (.snp) files.

1.43 RMU Restore Only_Root Command

By specifying the `Noupdate_Files` and `Noset_Tsn` qualifiers with the `RMU Restore Only_Root` command, you can use the following strategy to restore your database:

1. Restore the root from the most recent full by-area backup file.
2. Restore the storage areas by applying the by-area backup files in reverse order to their creation date.

Apply the most recent by-area backup file first and the oldest by-area backup file last. (Be sure you do not restore any area more than once.)

3. Recover the database by applying the after-image journal (.aij) files.
You can recover the .aij files manually by using the `RMU Recover` command. Or, if the state of your .aij files permits it, you can allow `RMU Restore Only_Root` to automatically recover the .aij files by *not* specifying the `Norecovery` qualifier with the last `RMU Restore` command you issue. For details on the automatic recovery feature of the `RMU Restore` command, see Section 1.42. (The automatic recovery feature is not available for the `RMU Restore Only_Root` command.)

When you use this strategy, be sure that the first `RMU Restore` command after the `RMU Restore Only_Root` command includes the most recent `RDB$SYSTEM` storage area. The `RDB$SYSTEM` storage area contains the structures needed to restore the other database storage areas. For this reason, Oracle Corporation suggests that you back up the `RDB$SYSTEM` storage area in every by-area backup operation you perform.

See Example 6 in the Examples section for a demonstration of this method.

Note that the database backup file must be recent—differences between the database and backup file must be known, and the number of storage areas must be unchanged since the backup file was created. If you have moved a storage area, use the `File` qualifier to show its new location and the `Snapshot` qualifier to indicate the current version of the area's .snp file.

Note

You must perform a full and complete backup operation on your database when the `RMU Restore Only_Root` command completes. Oracle Corporation recommends that you define a new after-image journal configuration with the `RMU Restore Only_Root` command by using either the `After_Journal` or the `Aij_Options` qualifier. This action ensures that the new .aij file can be rolled forward in the event that another database restore operation becomes necessary.

1.43 RMU Restore Only_Root Command

Command Parameters

backup-file-spec

A file specification for the backup file produced by a previous RMU Backup command. The default file extension is .rbf.

Note that you cannot perform a remote restore operation on an .rbf file that has been backed up to tape and then copied to disk. When copying .rbf files to disk from tape, be sure to copy them onto the system on which you will be restoring them.

Depending on whether you are performing a restore operation from magnetic tape, disk, or multiple disks, the backup file specification should be specified as follows:

- Restoring from magnetic tape

If you used multiple tape drives to create the backup file, the backup-file-spec parameter must be provided with (and only with) the first tape drive name. Additional tape drive names must be separated from the first and subsequent tape drive names with commas, as shown in the following example:

```
$ RMU/RESTORE /REWIND $111$MUA0:PERS_FULLL_NOV30.RBF,$112$MUA1:
```

- Restoring from multiple or single disk files

If you used multiple disk files to create the backup file, the backup-file-spec parameter must be provided with (and only with) the first disk device name. Additional disk device names must be separated from the first and subsequent disk device names with commas. You must include the Disk_file qualifier. For example:

```
RMU/RESTORE/ONLY_ROOT/DISK_FILE DISK1:[DIR1]MFP.RBF,DISK2:[DIR2],  
DISK3:[DIR3]
```

As an alternative to listing the disk device names on the command line (which can exceed the line-limit length for a command line if you use several devices), you can specify an options file in place of the backup-file-spec. For example:

```
$ RMU/RESTORE/ONLY-ROOT/DISK_FILE" @DEVICES.OPT"
```

The contents of devices.opt might appear as follows:

```
DISK1:[DIR1]MFP.RBF  
DISK2:[DIR2]  
DIS3:[DIR3]
```

1.43 RMU Restore Only_Root Command

The backup files referenced from such an options file are:

```
DISK1: [DIR1]MFP.RBF
DISK2: [DIR2]MFP01.RBF
DISK3: [DIR3]MFP02.RBF
```

storage-area-list

This option is a list of storage area names from the database. Use it in the following situations:

- When you need to change the values for thresholds with the `Thresholds` qualifier or blocks per page with the `Blocks_Per_Page` qualifier
- When you need to change the names or version numbers specified with the `Snapshot` or the `File` qualifier for the restored database

To use the `storage-area-list` option, specify the storage area *name*, not the system file name for the storage area. By restoring the database root only, you save the additional time normally needed to restore all the storage areas. Place commas between each storage area name in the list.

If the storage area parameters have changed since the file was last backed up, the `storage-area-list` option updates the `.rdb` file parameters so they agree with the current storage area parameters in terms of location and file version.

Command Qualifiers

Active_IO=max-reads

Specifies the maximum number of read operations to the backup file that the `RMU Restore Only_Root` command will attempt simultaneously. The value of the `Active_IO` qualifier can range from 1 to 5. The default value is 3.

After_Journal=file-spec

Noafter_Journal

Note

This qualifier is maintained for compatibility with versions of Oracle Rdb prior to Version 6.0. You might find it more useful to specify the `Aij_Options` qualifier, unless you are only interested in creating extensible `.aij` files.

1.43 RMU Restore Only_Root Command

Specifies how RMU Restore Only_Root is to handle after-image journaling and .ajj file creation, using the following rules:

- If you specify the `After_Journal` qualifier and provide a file specification, RMU Restore Only_Root creates a new extensible .ajj file and enables journaling.
- If you specify the `After_Journal` qualifier but you do not provide a file specification, RMU Restore Only_Root creates a new extensible .ajj file with the same name as the journal that was active at the time of the backup operation.
- If you specify the `Noafter_Journal` qualifier, RMU Restore Only_Root disables after-image journaling and does not create a new .ajj file. Note that if you specify the `Noafter_Journal` qualifier, there will be a gap in the sequence of .ajj files. For example, suppose your database has .ajj file sequence number 1 when you back it up. If you issue an RMU Restore Only_Root command with the `Noafter` qualifier, the .ajj file sequence number will be changed to 2. This means that you cannot (and do not want to) apply the original .ajj file to the restored database (doing so would result in a sequence mismatch).
- If you do not specify an `After_Journal`, `Noafter_Journal`, `Aij_Options`, or `Noaij_Options` qualifier, RMU Restore Only_Root recovers the journal state (enabled or disabled) and tries to reuse the .ajj file or files.

If you choose this option, take great care to either set the database root TSN and CSN correctly, or create a full and complete backup file of the database. Failure to do so might make it impossible for you to recover your database from the .ajj file should it become necessary.

However, if the .ajj file or files are not available (for example, they have been backed up), after-image journaling is disabled.

You cannot use the `After_Journal` qualifier to create fixed-size .ajj files; use the `Aij_Options` qualifier.

Aij_Options=journal-opts

Noaij_Options

Specifies how RMU Restore Only_Root is to handle after-image journaling and .ajj file creation, using the following rules:

- If you specify the `Aij_Options` qualifier and provide a journal-opts file, RMU Restore Only_Root enables journaling and creates the .ajj file or files you specify for the restored database. If only one .ajj file is created for the restored database, it will be an extensible .ajj file. If two or more .ajj files

1.43 RMU Restore Only_Root Command

are created for the database copy, they will be fixed-size .aij files (as long as at least two .aij files are always available).

- If you specify the Aij_Options qualifier, but do not provide a journal-opt file, RMU Restore Only_Root disables journaling and does not create any new .aij files.
- If you specify the Noaij_Options qualifier, RMU Restore Only_Root disables journaling and does not create any new .aij files.
- If you do not specify an After_Journal, Noafter_Journal, Aij_Options, or Noaij_Options qualifier, RMU Restore Only_Root recovers the journaling state (enabled or disabled) and tries to reuse the .aij file or files.

If you choose this option, take great care to either set the database root TSN and CSN correctly, or create a full and complete backup file of the database. Failure to do so might make it impossible for you to recover your database from the .aij file should it become necessary.

However, if the .aij file or files are not available (for example, they have been backed up), after-image journaling is disabled.

See Section 1.61.1 for information on the format of a journal-opt-file.

Directory=directory-spec

Specifies the default directory for the database root and the default directory for where the root can expect to find the database storage areas and snapshot files.

See the Usage Notes for information on how this qualifier interacts with the Root, File, and Snapshot qualifiers and for warnings regarding restoring database files into a directory owned by a resource identifier.

Initialize_Tsns

Noinitialize_Tsns

Initializes all transaction sequence number (TSN) values for the entire database by setting the values to zero. Each time a transaction is initiated against a database, a TSN is issued. The numbers are incremented sequentially over the life of the database.

TSN and CSN values are each contained in a quadword with the following decimal format:

```
high longword : low longword
```

The high longword can hold a maximum user value of 32768 (2^{15}) and the low longword can hold a maximum user value of 4,294,967,295 (2^{32}). A portion of the high longword is used by Oracle Rdb for overhead.

1.43 RMU Restore Only_Root Command

When you specify a TSN or CSN, you can omit the high longword and the colon if the TSN or CSN fits in the low longword. For example 0:444 and 444 are both valid input values.

As your next TSN value approaches the maximum value allowed, you should initialize the TSNs. You can determine the next TSN and next commit sequence number (CSN) values by dumping the database root file, using the RMU Dump command with the Header and Option=Debug qualifiers.

The Initialize_Tsns qualifier takes much more time to execute because all TSN values in the database are set to zero, which requires writing to every page in the database. When the database TSNs are reset, using the Initialize_Tsns qualifier, you should use the After_Journal qualifier or the Aij_Options qualifier and immediately perform a full database backup operation and create a new .aj file. This ensures continuity of journaling and the ability to recover the database.

The default Noinitialize_Tsns qualifier does not initialize the database TSNs.

Note that you cannot use the Initialize_Tsns with the Set_Tsn or Noset_Tsn qualifier in the same command. This restriction is required because Initialize_Tsns directs RMU Restore Only_Root to reset the TSN value to zero, while Set_Tsn directs RMU Restore Only_Root to reset the TSN to the value you have indicated, and Noset_Tsn leaves the TSN value unchanged.

CAUTION

Never use the Initialize_Tsns qualifier if the Replication Option for Rdb transfers have been defined for the database. The Initialize_Tsns qualifier does not reset the Replication Option for Rdb transfers.

Label=(label-name-list)

Specifies the 1- to 6-character string with which the volumes of the backup file have been labeled. The Label qualifier is applicable only to tape volumes. You must specify one or more label names when you use the Label qualifier.

You can specify a list of tape labels for multiple tapes. If you list multiple tape label names, separate the names with commas, and enclose the list of names within parentheses.

In a normal restore operation, the Label qualifier you specify with the RMU Restore Only_Root command should be the same Label qualifier you specified with the RMU Backup command you used to back up your database.

1.43 RMU Restore Only_Root Command

The Label qualifier can be used with indirect file references. See Section 1.3 for more information.

Librarian[=options]

Use the Librarian qualifier to restore files from data archiving software applications that support the Oracle Media Management interface. The file name specified on the command line identifies the stream of data to be retrieved from the Librarian utility. If you supply a device specification or a version number it will be ignored.

Oracle RMU supports retrieval using the Librarian qualifier only for data that has been previously stored by Oracle RMU using the Librarian qualifier.

The Librarian qualifier accepts the following options:

- **Trace_file=file-specification**
The Librarian utility writes trace data to the specified file.
- **Level_Trace=n**
Use this option as a debugging tool to specify the level of trace data written by the Librarian utility. You can use a pre-determined value of 0, 1, or 2, or a higher value defined by the Librarian utility. The pre-determined values are :
 - Level 0 traces all error conditions. This is the default.
 - Level 1 traces the entry and exit from each Librarian function.
 - Level 2 traces the entry and exit from each Librarian function, the value of all function parameters, and the first 32 bytes of each read/write buffer, in hexadecimal.
- **Logical_Names=(logical_name=equivalence-value,...)**
You can use this option to specify a list of process logical names that the Librarian utility can use to specify catalogs or archives where Oracle Rdb backup files are stored, Librarian debug logical names, and so on. See the specific Librarian documentation for the definition of logical names. The list of process logical names is defined by Oracle RMU prior to the start of any Oracle RMU command that accesses the Librarian application.

The following OpenVMS logical names must be defined for use with a Librarian utility before you execute an Oracle RMU backup or restore operation. Do not use the Logical_Names option provided with the Librarian qualifier to define these logical names.

- **RMU\$LIBRARIAN_PATH**

1.43 RMU Restore Only_Root Command

This logical name must be defined so that the shareable Librarian image can be loaded and called by Oracle RMU backup and restore operations. The translation must include the file type (for example, .exe), and must not include a version number. The shareable Librarian image must be an installed (known) image. See the Librarian implementation documentation for the name and location of this image and how it should be installed.

- **RMU\$DEBUG_SBT**

This logical name is not required. If it is defined, Oracle RMU will display debug tracing information messages from modules that make calls to the Librarian shareable image.

You cannot use device specific qualifiers such as Rewind, Density, or Label with the Librarian qualifier because the Librarian utility handles the storage media, not Oracle RMU.

Log

Nolog

Specifies whether the processing of the command is reported to SYS\$OUTPUT. Specify the Log qualifier to request that the progress of the restore operation be written to SYS\$OUTPUT and the Nolog qualifier to suppress this report. If you specify neither, the default is the current setting of the DCL verify switch. (The DCL SET VERIFY command controls the DCL verify switch.)

Media Loader

Nomedia Loader

Use the Media Loader qualifier to specify that the tape device from which the backup file is being read has a loader or stacker. Use the Nomedia Loader qualifier to specify that the tape device does not have a loader or stacker.

By default, if a tape device has a loader or stacker, RMU Restore Only_Root should recognize this fact. However, occasionally RMU Restore Only_Root does not recognize that a tape device has a loader or stacker. Therefore, when the first tape has been read, RMU Restore Only_Root issues a request to the operator for the next tape, instead of requesting the next tape from the loader or stacker. Similarly, sometimes RMU Restore Only_Root behaves as though a tape device has a loader or stacker when actually it does not.

If you find that RMU Restore Only_Root is not recognizing that your tape device has a loader or stacker, specify the Media Loader qualifier. If you find that RMU Restore Only_Root expects a loader or stacker when it should not, specify the Nomedia Loader qualifier.

1.43 RMU Restore Only_Root Command

New_Snapshots

Nonew_Snapshots

Allows you to specify whether to create new snapshot (.snp) files as part of a Restore Only_Root operation.

The default is the Nonew_Snapshots qualifier, which causes the command to initialize the existing .snp files.

If you specify the New_Snapshots qualifier, the command creates and initializes new .snp files. When you specify the New_Snapshots qualifier, you should either delete the existing .snp files before the restore operation or purge the .snp files afterwards.

Nodes_Max=number-cluster-nodes

Specifies a new upper limit on the number of VMSccluster nodes from which users can access the restored database. The Nodes_Max qualifier will accept values between 1 and 96 VMSccluster nodes. The actual maximum is the highest number of VMSccluster nodes possible in the current version of OpenVMS. The default value is the limit defined for the database before it was backed up.

Options=file-spec

Specifies the options file that contains storage area names, followed by the storage area qualifiers that you want applied to that storage area.

You can direct RMU Restore Only_Root to create an options file for use with this qualifier by specifying the Restore_Options qualifier with the RMU Backup, RMU Dump, and RMU Dump Backup commands. See Section 1.10, Section 1.19, and Section 1.21 for details.

If you create your own options file, *do not* separate the storage area names with commas. Instead, put each storage area name on a separate line in the file. The storage area qualifiers that you can include in the options file are: Blocks_Per_Page, File, Snapshot, and Thresholds. You can use the DCL line continuation character, a hyphen (-), or the comment character (!) in the options file. The default file extension is .opt. See Example 5 in the Examples section.

Rewind

Norewind

Specifies whether the tape that contains the backup file will be rewound before processing begins. The Norewind qualifier, the default, causes the search for the backup file to begin at the current tape position.

1.43 RMU Restore Only_Root Command

The Rewind and Norewind qualifiers are applicable only to tape devices. RMU Restore Only_Root returns an error message if you use these qualifiers and the device is not a tape device.

Root=root-file-spec

Requests that the database root (.rdb) be restored to the specified location.

See the Usage Notes for information on how this qualifier interacts with the Directory, File, and Snapshot qualifiers and for warnings regarding restoring database files into a directory owned by a resource identifier.

The Root qualifier is only meaningful when used with a multifile database.

Set_Tsn=(Tsn=n, Csn=m)

Noset_Tsn

The Set_Tsn qualifier sets the database transaction sequence number (TSN) and commit sequence number (CSN) to the specified values. The correct value can be extracted from the original .rdb file if it is still accessible, or from the last .ajj file if one is available. If that fails, you can use a TSN value larger than the maximum number of transactions applied to the database since it was created, or since TSNs were last initialized.

The TSN and CSN values do not have to be the same value. However, you need to choose new values that are greater than the last values assigned to a transaction. Set_Tsn values are expected to be multiples of eight. If you specify a value that is not a multiple of eight, RMU Restore Only_Root assigns the next highest value that is a multiple of eight. (For example, if you specify Set_Tsn=(Tsn=90, Csn=90), RMU Restore Only_Root assigns the Next TSN a value of 96.)

The default value for the Set_Tsn qualifier is the TSN and CSN values stored in the backup file plus 1,000,000 when TSNs are not being initialized. The new TSN and CSN values for most database applications should be larger than the number of transactions committed since the database was last backed up. Set the TSN and CSN values higher than this default increment value plus the value in the backup file when needed. You can determine the next TSN and CSN values by dumping the .rdb file, using the Option=Debug qualifier.

The TSN and CSN values are each contained in a quadword with the following decimal format:

```
high longword : low longword
```

The high longword can hold a maximum user value of 32768 (2^{15}) and the low longword can hold a maximum user value of 4,294,967,295 (2^{32}). A portion of the high longword is used by Oracle Rdb for overhead.

1.43 RMU Restore Only_Root Command

When you specify a TSN or CSN, you can omit the high longword and the colon if the TSN fits in the low longword. For example 0:444 and 444 are both valid TSN input values.

The `Noset_Tsn` qualifier specifies that the root will be restored with the same TSN state as was recorded in the backup file.

When you use the `Noset_Tsn` qualifier in conjunction with the `Noupdate_Files` qualifier, you can use a backup strategy that uses recent by-area full backup files in place of a recent full and complete backup file of the entire database. See Example 6 in the Examples section.

Note that you cannot use the `Initialize_Tsns` with the `Set_Tsn` or `Noset_Tsn` qualifier in the same command. This restriction is required because `Initialize_Tsns` directs RMU Restore Only_Root to reset the TSN value to zero, while `Set_Tsn` directs RMU Restore Only_Root to reset the TSN to the value you have indicated, and `Noset_Tsn` leaves the TSN value unchanged.

Transaction_Mode=(mode-list)

Sets the allowable transaction modes for the database root file created by the restore operation. The mode-list can include one or more of the following transaction modes:

- All - Enables all transaction modes
- Current - Enables all transaction modes that are set for the source database. This is the default transaction mode.
- None - Disables all transaction modes
- [No]Batch_Update
- [No]Read_Only
- [No]Exclusive
- [No]Exclusive_Read
- [No]Exclusive_Write
- [No]Protected
- [No]Protected_Read
- [No]Protected_Write
- [No]Read_Write
- [No]Shared
- [No]Shared_Read

1.43 RMU Restore Only_Root Command

- [No]Shared_Write

If you specify more than one transaction mode in the mode-list, enclose the list in parenthesis and separate the transaction modes from one another with a comma. Note the following:

- When you specify a negated transaction mode, for example Noexclusive_Write, it indicates that exclusive write is not an allowable access mode for the copied database.
- If you specify the Shared, Exclusive, or Protected transaction mode, Oracle RMU assumes you are referring to both reading and writing in that transaction mode.
- No mode is enabled unless you add that mode to the list, or you use the All option to enable all transaction modes.
- You can list one transaction mode that enables or disables a particular mode followed by another that does the opposite. For example, Transaction_Mode=(Noshared_Write, Shared) is ambiguous because the first value disables Shared_Write access and the second value enables Shared_Write access. Oracle RMU resolves the ambiguity by first enabling the modes as specified in the modes-list and then disabling the modes as specified in the modes-list. The order of items in the list is irrelevant. In the example presented previously, Shared_Read is enabled and Shared_Write is disabled.

Update_Files

Noupdate_Files

The Update_Files qualifier specifies that the root will be restored, and RMU Restore Only_Root will attempt to link that restored root to the area files. In addition, the snapshot (.snp) file will be updated or created. This is the default.

The Noupdate_Files qualifier specifies that the restore operation will restore the root, but it will not link that restored root to any of the area files, nor will it create or update the .snp files.

When you use the Noupdate_Files qualifier in conjunction with the Noset_Tsn qualifier, you can use a backup strategy that uses recent by-area full backup files in place of a recent full and complete backup file of the entire database. See Example 6 in the Examples section.

Users_Max=number-users

Specifies a new upper limit on the number of users that can simultaneously access the restored database. The valid range is between 1 and 2032 users. The default value is the value defined for the database before it was backed up.

1.43 RMU Restore Only_Root Command

Note

Use these qualifiers to reconcile the information in the database root file with the storage area files on disk. These values can get out of synchronization when changes have been made to storage areas or snapshot files after the backup from which you are restoring the database root file was created.

Setting these parameters updates the data in the root file only; it does not change the attributes of the storage areas or snapshot files themselves.

File or Area Qualifiers

Blocks_Per_Page=integer

Noblocks_Per_Page

Updates the database root file with the number of blocks per page for the storage area. Use this qualifier to update the root when the blocks per page for a storage area has changed since the backup file from which you are restoring was created. This qualifier does not change the page size of a storage area itself; its purpose is to update the database root file with corrected information.

If you use the default, the Noblocks_Per_Page qualifier, RMU Restore Only_Root takes the page size for the storage area from the page size specified for the database you backed up. This is a positional qualifier. This qualifier conflicts with storage areas that have a uniform page format.

File=file-spec

Updates the database root file with the file specification for the storage-area-name parameter it qualifies. Use this qualifier to update the root when the file specification for a storage area has changed since the backup file from which you are restoring the root was created. (For example, if you have used the RMU Move_Area command since the backup file was created.) This qualifier does not change the file specification of the storage area it qualifies; its purpose is to update the database root file with corrected information. When you specify the File qualifier, you must supply a file name.

See the Usage Notes for information on how this qualifier interacts with the Root, Snapshot, and Directory qualifiers.

This qualifier is not valid for single-file databases. This is a positional qualifier.

1.43 RMU Restore Only_Root Command

Read_Only

Updates the database root file to reflect the read-only attribute for the storage area it qualifies. Use this qualifier to update the root when the read/write or read-only attribute has changed since the backup file from which you are restoring has changed. This qualifier does not change the attribute of the storage area it qualifies; its purpose is to update the database root file with corrected information.

If you do not specify the `Read_Only` or the `Read_Write` qualifier, the storage areas is restored with the read/write attributes that were in effect when the database was backed up.

Read_Write

Updates the database root file to reflect the read/write attribute for the storage area it qualifies. Use this qualifier to update the root when the read/write or read-only attribute has changed since the backup file from which you are restoring has changed. This qualifier does not change the attribute of the storage area it qualifies; its purpose is to update the database root file with corrected information.

If you do not specify the `Read_Only` or the `Read_Write` qualifier, the storage areas is restored with the read/write attributes that were in effect when the database was backed up.

Snapshot=(Allocation=n,File=file-spec)

Updates the database root file to reflect the snapshot allocation or snapshot file specification (or both) for the area it qualifies. Use this qualifier to update the root when the snapshot attributes have changed since the backup file from which you are restoring the database root has changed. This qualifier does not change the attributes of the snapshot file it qualifies; its purpose is to update the database root file with corrected information.

See the Usage Notes for information on how this qualifier interacts with the `Root`, `Snapshot`, and `Directory` qualifiers.

The `Snapshot` qualifier is a positional qualifier.

When you do not specify the `Snapshot` qualifier, `RMU Restore Only_Root` restores snapshot areas according to the information stored in the backup file.

Spams

Nospams

Updates the database root file to reflect the space area management (SPAM) information for the storage areas in the storage-area-list. Use this qualifier when the setting of SPAM pages (enabled or disabled) has changed since the backup file from which you are restoring the root was created. This qualifier

1.43 RMU Restore Only_Root Command

does not change the attributes of the storage area it qualifies; its purpose is to update the database root file with corrected information.

Use the Spams qualifier to update the root file information to indicate that SPAM pages are enabled for the storage areas qualified; use the Nospams qualifier to update the root file information to indicate that SPAM pages are disabled for the storage areas qualified. The default is to leave the attribute unchanged from the setting recorded in the backup file. This is a positional qualifier.

Thresholds=(val1[,val2[,val3]])

Updates the database root file to reflect the threshold information for the storage areas in the storage-area-list. Use this qualifier when the threshold values have changed since the backup file from which you are restoring the root was created. This qualifier does not change the attributes of the storage area it qualifies; its purpose is to update the database root file with corrected information.

This is a positional qualifier.

The Thresholds qualifier applies only to storage areas with a mixed page format.

If you do not use the Thresholds qualifier with the RMU Restore Only_Root command, Oracle Rdb uses the storage area's thresholds as recorded in the backup file.

See the *Oracle Rdb7 Guide to Database Performance and Tuning* for more information on SPAM thresholds.

Usage Notes

- To use the RMU Restore Only_Root command for a database, you must have the RMU\$RESTORE privilege in the root file access control list (ACL) for the database or the OpenVMS SYSPRV or BYPASS privilege.
- The RMU Restore Only_Root command provides two qualifiers, Directory, and Root, that allow you to specify the target for the restored database root file. In addition, the Directory, File, and Snapshot file qualifiers allow you to specify a target for updates to the database root for the storage area and snapshot file locations. The **target** can be just a directory, just a file name, or a directory and file name.

1.43 RMU Restore Only_Root Command

If you use all or some of these qualifiers, apply them as follows:

- Use the Root qualifier to indicate the target for the restored database root file.
- Use local application of the File qualifier to specify the current location of a storage area file if its location has changed since the database was backed up. The storage area is not affected by this qualifier. This qualifier updates the location of the storage area as recorded in the database root file.
- Use local application of the Snapshots qualifier to specify the current location of a snapshot file if its location has changed since the database was backed up. The snapshot file is not affected by this qualifier. This qualifier updates the location of the snapshot file as recorded in the database root file.
- Use the Directory qualifier to specify a default target directory for the root file and as a default directory for where the storage areas and snapshot files currently reside. The default target directory is where the database root file is restored if a directory specification is not specified with the Root qualifier. The default directory for the storage area and snapshot files is the directory specification with which the root file is updated if these files are not qualified with the Root, File, or Snapshot qualifier. It is also the default directory with which the Root file is updated for files qualified with the Root, File, or Snapshot qualifier if these qualifiers do not include a directory specification.

Note the following when using these qualifiers:

- Global application of the File qualifier when the target specification includes a file name causes RMU Restore Only_Root to update the file name recorded in the database root file for all storage areas to be the same file name.
- Global application of the Snapshot qualifier when the target specification includes a file name causes RMU Restore Only_Root to update the file name recorded in the database root file for all snapshot files to be the same file name.
- Specifying a file name or extension with the Directory qualifier is permitted, but causes RMU Restore Only_Root to restore the database root file to the named directory and file and update the file name recorded in the database root file for all the storage areas and snapshot files to be the same directory and file specification.

1.43 RMU Restore Only_Root Command

- When you restore a database root into a directory owned by a resource identifier, the ACE for the directory is applied to the database root file ACL first, and then the Oracle RMU ACE is added. This method is employed to prevent database users from overriding OpenVMS file security. However, this can result in a database which you consider yours, but to which you have no Oracle RMU privileges to access. See the *Oracle Rdb Guide to Database Maintenance* for details.
- Only the database parameter values and the storage area parameter values for which there are qualifiers can be updated in the database root (.rdb) file using the restore-only-root operation. All other database and storage area parameter values that have changed since the database was last backed up must be reapplied to the .rdb file using the SQL ALTER DATABASE statement.
- There are no restrictions on the use of the Nospams qualifier option with storage areas that have a mixed page format, but the use of the Nospams qualifier typically causes severe performance degradation. The Nospams qualifier is useful only where updates are rare and batched, and access is primarily by database key (dbkey).
- You must set both TSN and CSN values at the same time. You cannot set the TSN value lower than the CSN value; however, you can set a CSN value higher than the TSN value.
- The RMU Restore Only_Root command cannot be used if any storage area has been extended since the backup operation was done. You can use the RMU Dump Backup command with the Option=Root qualifier to determine if this is the case.

Examples

Example 1

To prevent corruption of your databases, check your CSN and TSN values and set them to zero based on when they approach the maximum. First, enter an RMU Dump command to display the next CSN and next TSN values:

1.43 RMU Restore Only_Root Command

```
$ RMU/DUMP/HEADER=(SEQUENCE_NUMBERS) MF_PERSONNEL
.
.
.
Sequence Numbers...
- Transaction sequence number
  Next number is 0:256
  Group size is 0:32
- Commit sequence number
  Next number is 0:256
  Group size is 0:32
```

If the next CSN and the next TSN values are approaching the maximum number allowed, you must perform the following operations to initialize all TSN and CSN values to the value zero in your database. The operation might take some time to execute as it writes to every page in the database.

First, create a backup file for the database. Then restore the database and initialize the CSN and TSN values with the Initialize_Tsns qualifier. Then, enter an RMU Dump command again to examine the next CSN and next TSN values. This example shows that both values have been set to zero. If you displayed the database pages, you would also notice that all TSN and CSN values are set to zero.

```
$ RMU/BACKUP MF_PERSONNEL MF_PER_124.RBF
$ RMU/RESTORE/ONLY_ROOT /INITIALIZE_TSNS MF_PER_124.RBF
$ RMU/DUMP/HEADER=(SEQUENCE_NUMBERS) MF_PERSONNEL
.
.
.
Sequence Numbers...
- Transaction sequence number
  Next number is 0:0
  Group size is 0:32
- Commit sequence number
  Next number is 0:0
  Group size is 0:32
```

Example 2

Perform the following to set the TSN and CSN values to a number that you select; a number that is greater than or equal to the next CSN and next TSN values. If the number you have selected is less than the next CSN and next TSN values recorded in the database header, you receive an error as follows:

1.43 RMU Restore Only_Root Command

```
$ RMU/RESTORE/ONLY_ROOT/SET_TSN=(TSN=40,CSN=40)
_ $ MF_PERSONNEL.RBF
%RMU-F-TSNLSSMIN, value (0:40) is less than minimum
  allowed value (0:224) for /SET_TSN=TSN
%RMU-F-FTL_RSTR, Fatal error for RESTORE operation
  at 18-JUN-1997 16:59:19.32
```

Enter a number equal to or greater than the next CSN and next TSN values recorded in the database header:

```
$ RMU/RESTORE/ONLY_ROOT/SET_TSN=(TSN=274,CSN=274) -
_ $ MF_PERSONNEL.RBF
```

Enter an RMU Dump command to see the next CSN and next TSN values:

```
$ RMU/DUMP/HEADER=(SEQUENCE_NUMBERS) MF_PERSONNEL
.
.
.
Sequence Numbers...
- Transaction sequence number
  Next number is 0:288
  Group size is 0:32
- Commit sequence number
  Next number is 0:288
  Group size is 0:32
- Database bind sequence number
  Next number is 0:288
```

Example 3

The following RMU Restore Only_Root command restores the database root file from the database backup file (.rbf) to another device:

```
$ RMU/RESTORE/ONLY_ROOT/ROOT=DXXV9:[BIGLER.TESTING]MF_PERSONNEL -
_ $ MF_PERSONNEL_BACKUP.RBF
```

The following DIRECTORY command confirms that the MF_PERSONNEL.RDB file was restored in the specified directory:

```
$ DIRECTORY DXXV9:[BIGLER.TESTING]MF_PERSONNEL.RDB
Directory DXXV9:[BIGLER.TESTING]
MF_PERSONNEL.RDB;1 21-JAN-1991 14:37:36.87
Total of 1 file.
```

1.43 RMU Restore Only_Root Command

Example 4

Use the File=file-spec qualifier to update the .rdb file with a storage area's new location. If you have moved a storage area to a new location, use the File qualifier to show its new location and the Snapshot qualifier to indicate the current version of the area's snapshot (.snp) file. Enter the following RMU commands to execute a series of operations that use the File and Snapshot qualifiers in a restore-only-root operation to update the .rdb file with new information since the database was last backed up.

Back up the database file:

```
$ RMU/BACKUP MF_PERSONNEL MFPERS_122.RBF.
```

Move the area to another directory:

```
$ RMU/MOVE_AREA MF_PERSONNEL JOBS -  
_$_ /FILE=[BIGLER.MFTEST.TEST1]JOBS.RDA
```

With the RMU Restore Only_Root command, give the area name, and specify both the storage area file specification and its new location. Also specify the snapshot (.snp) file with its correct version. Note that .snp file version numbers increment with the RMU Move_Area command.

```
$ RMU/RESTORE/ONLY_ROOT MFPERS_122.RBF JOBS -  
_$_ /FILE=[BIGLER.MFTEST.TEST1]JOBS.RDA -  
_$_ /SNAPSHOT=(FILE=[BIGLER.V41MFTEST]JOBS.SNP;2)
```

Display the .rdb file header and note that the file is correctly updated.

The dump of the database root file lists these file specifications:

```
$ RMU/DUMP/HEADER MF_PERSONNEL  
DXXV9: [BIGLER.MFTEST.TEST1]JOBS.RDA;1  
DXXV9: [BIGLER.MFTEST]JOBS.SNP;2
```

Verify the .rdb file to be certain that it has been properly and completely updated relative to the files and their version numbers that comprise the database.

```
$ RMU/VERIFY/ROOT MF_PERSONNEL
```

Example 5

The following command achieves the same results as the RMU Restore Only_Root command in Example 4, but uses an options file to specify the current location of the JOBS storage area and the associated .snp file.

1.43 RMU Restore Only_Root Command

```
$ RMU/RESTORE/ONLY_ROOT MFPERS_122.RBF -
_ $ JOBS/OPTIONS=OPTIONS_FILE.OPT
$ !
$ TYPE OPTIONS_FILE.OPT
JOBS /FILE=[BIGLER.V41MFTTEST.TEST1]JOBS.RDA -
      /SNAPSHOT=(FILE=BIGLER.V41MFTTEST)JOBS.SNP)
```

Example 6

The following example demonstrates the use of the `Noset_Tsn` qualifier and the `Noupdate_Files` qualifier to restore a database using by-area backup files. In addition, it demonstrates the automatic recovery feature of the RMU Restore command.

```
$ !
$ SET DEFAULT DISK1:[USER]
$ !
$ ! Create .aij files for the database. Because three .aij files are
$ ! created, fixed-size after-image journaling will be used.
$ !
$ RMU/SET AFTER_JOURNAL/ENABLE/RESERVE=4      -
_ $ /ADD=(name=AIJ1, FILE=DISK2:[CORP]AIJ_ONE)  -
_ $ /ADD=(name=AIJ2, FILE=DISK2:[CORP]AIJ_TWO)  -
_ $ /ADD=(NAME=AIJ3, FILE=DISK2:[CORP]AIJ_THREE) -
_ $ MF_PERSONNEL
%RMU-W-DOFULLBCK, full database backup should be done to
  ensure future recovery
$ !
$ !
$ ! For the purposes of this example, assume the backup operation
$ ! recommended in the preceding warning message is done, but
$ ! that the time between this backup operation and the following
$ ! operations is several months so that this backup file is too
$ ! old to use in an efficient restore operation.
$ !
$ ! Update the DEPARTMENTS table.
$ !
$ SQL
SQL> ATTACH 'FILENAME MF_PERSONNEL';
SQL> --
SQL> -- On Monday, insert a new row in the DEPARTMENTS table. The
SQL> -- new row is stored in the DEPARTMENTS storage area.
SQL> --
SQL> INSERT INTO DEPARTMENTS
cont>   (DEPARTMENT_CODE, DEPARTMENT_NAME, MANAGER_ID,
cont>   BUDGET_PROJECTED, BUDGET_ACTUAL)
cont>   VALUES ('WLNS', 'Wellness Center', '00188', 0, 0);
1 row inserted
SQL>
```

1.43 RMU Restore Only_Root Command

```
SQL> COMMIT;
SQL> DISCONNECT DEFAULT;
SQL> EXIT
$ !
$ ! Perform a by-area backup operation, including half of the
$ ! storage areas from the mf_personnel database.
$ !
$ RMU/BACKUP/INCLUDE=(RDB$SYSTEM, EMPIDS_LOW, EMPIDS_MID, -
_$ EMPIDS_OVER, DEPARTMENTS) MF_PERSONNEL -
_$ DISK3:[BACKUP]MONDAY_FULL.RBF
%RMU-I-NOTALLARE, Not all areas will be included in
  this backup file
$ !
$ ! Update the SALARY_HISTORY table.
$ !
$ SQL
SQL> ATTACH 'FILENAME MF_PERSONNEL';
SQL> --
SQL> -- On Tuesday, one row is updated in the
SQL> -- SALARY_HISTORY storage area.
SQL> --
SQL> UPDATE SALARY_HISTORY
cont>   SET SALARY_END ='20-JUL-1993 00:00:00.00'
cont>   WHERE SALARY_START='14-JAN-1983 00:00:00.00'
cont>   AND EMPLOYEE_ID = '00164';
1 row updated
SQL> COMMIT;
SQL> DISCONNECT DEFAULT;
SQL> EXIT
$ !
$ ! On Tuesday, back up the other half of the storage areas.
$ !
$ RMU/BACKUP/INCLUDE=(SALARY_HISTORY, JOBS, EMP_INFO, -
_$ MF_PERS_SEGSTR, RDB$SYSTEM) MF_PERSONNEL -
_$ DISK3:[BACKUP]TUESDAY_FULL.RBF
%RMU-I-NOTALLARE, Not all areas will be included in this
  backup file
$ !
$ ! On Wednesday, perform additional updates.
$ !
$ SQL
SQL> ATTACH 'FILENAME MF_PERSONNEL';
SQL> --
SQL> -- Update another row in the SALARY_HISTORY table:
SQL> UPDATE SALARY_HISTORY
cont>   SET SALARY_START ='23-SEP-1991 00:00:00.00'
cont>   WHERE SALARY_START='21-SEP-1981 00:00:00.00'
cont>   AND EMPLOYEE_ID = '00164';
1 row updated
SQL> COMMIT;
SQL> DISCONNECT DEFAULT;
SQL> EXIT
```

1.43 RMU Restore Only_Root Command

```
$ !
$ ! Assume the database is lost on Wednesday.
$ !
$ ! Restore the database root from the latest full-area backup file.
$ !
$ RMU/RESTORE/ONLY_ROOT/NOUPDATE_FILES/NOSET_TSN -
_$ DISK3:[BACKUP]TUESDAY_FULL.RBF/LOG
%RMU-I-AIJRSTBEG, restoring after-image journal "state" information
%RMU-I-AIJRSTJRN, restoring journal "AIJ1" information
%RMU-I-AIJRSTSEQ, journal sequence number is "0"
%RMU-I-AIJRSTSUC, journal "AIJ1" successfully restored from
file "DISK2:[CORP]AIJ_ONE.AIJ;1"
%RMU-I-AIJRSTJRN, restoring journal "AIJ2" information
%RMU-I-AIJRSTNMD, journal has not yet been modified
%RMU-I-AIJRSTSUC, journal "AIJ2" successfully restored from
file "DISK2:[CORP]AIJ_TWO.AIJ;1"
%RMU-I-AIJRSTJRN, restoring journal "AIJ3" information
%RMU-I-AIJRSTNMD, journal has not yet been modified
%RMU-I-AIJRSTSUC, journal "AIJ3" successfully restored from
file "DISK2:[CORP]AIJ_THREE.AIJ;1"
%RMU-I-AIJRSTEND, after-image journal "state" restoration complete
%RMU-I-RESTXT_00, Restored root file
DISK1:[USER]MF_PERSONNEL.RDB;1
%RMU-I-AIJRECBEG, recovering after-image journal "state" information
%RMU-I-AIJRSTAVL, 3 after-image journals available for use
%RMU-I-AIJRSTMOD, 1 after-image journal marked as "modified"
%RMU-I-LOGMODSTR, activated after-image journal "AIJ2"
%RMU-I-AIJISON, after-image journaling has been enabled
%RMU-W-DOFULLBCK, full database backup should be done to
ensure future recovery
%RMU-I-AIJRECEND, after-image journal "state" recovery complete
```

1.43 RMU Restore Only_Root Command

```
$ !
$ ! Restore the database areas, starting with the most recent
$ ! full-area backup file. (If the RDB$SYSTEM area is not in the
$ ! most recent full-area backup file, however, it must be restored
$ ! first.) Do not restore any area more than once.
$ !
$ ! Specify the Norecovery qualifier since there are additional
$ ! backup files to apply.
$ !
$ RMU/RESTORE/AREA/NOCD/NORECOVER -
_$ DISK3:[BACKUP]TUESDAY_FULL.RBF -
_$ RDB$SYSTEM, SALARY_HISTORY, JOBS, -
_$ EMP_INFO, MF_PERS_SEGSTR/LOG
%RMU-I-RESTXT_21, Starting full restore of storage area
  DISK1:[USER]MF_PERS_DEFAULT.RDA;1 at 18-JUN-1997 16:14:40.88
%RMU-I-RESTXT_21, Starting full restore of storage area
  DISK1:[USER]SALARY_HISTORY.RDA;1 at 18-JUN-1997 16:14:41.28
%RMU-I-RESTXT_21, Starting full restore of storage area
  DISK1:[USER]JOBS.RDA;1 at 18-JUN-1997 16:14:41.83
%RMU-I-RESTXT_21, Starting full restore of storage area
  DISK1:[USER]EMP_INFO.RDA;1 at 18-JUN-1997 16:14:42.06
%RMU-I-RESTXT_21, Starting full restore of storage area
  DISK1:[USER]MF_PERS_SEGSTR.RDA;1 at 18-JUN-1997 16:14:42.27
%RMU-I-RESTXT_24, Completed full restore of storage area
  DISK1:[USER]JOBS.RDA;1 at 18-JUN-1997 16:14:42.49
%RMU-I-RESTXT_24, Completed full restore of storage area
  DISK1:[USER]EMP_INFO.RDA;1 at 18-JUN-1997 16:14:42.74
.
.
%RMU-I-RESTXT_01, Initialized snapshot file
  DISK1:[USER]MF_PERS_DEFAULT.SNP;1
%RMU-I-LOGINIFIL,      contains 100 pages, each page
  is 2 blocks long
%RMU-I-RESTXT_01, Initialized snapshot file
  DISK1:[USER]EMP_INFO.SNP;1
%RMU-I-LOGINIFIL,      contains 100 pages, each page
  is 2 blocks long
.
.
%RMU-I-AIJWASON, AIJ journaling was active when
  the database was backed up
%RMU-I-AIJRECFUL, Recovery of the entire database
  starts with AIJ file sequence 0
%RMU-I-COMPLETED, RESTORE operation completed
  at 18-JUN-1997 16:14:46.82
```

1.43 RMU Restore Only_Root Command

```
$ !
$ ! Complete restoring database areas by applying the most
$ ! recent full-area backup file. However, do not include
$ ! the RDB$SYSTEM table because that was already restored
$ ! in the previous restore operation. This restore
$ ! operation will attempt an automatic recovery of the .aij files.
$ !
$ RMU/RESTORE/AREA/NOCD DISK3:[BACKUP]MONDAY_FULL.RBF -
_$ EMPIDS_LOW, EMPIDS_MID, EMPIDS_OVER, DEPARTMENTS/LOG
%RMU-I-RESTXT_21, Starting full restore of storage area
DISK1:[USER]EMPIDS_OVER.RDA;1 at 18-JUN-1997 16:20:05.08
%RMU-I-RESTXT_21, Starting full restore of storage area
DISK1:[USER]EMPIDS_MID.RDA;1 at 18-JUN-1997 16:20:05.40
%RMU-I-RESTXT_21, Starting full restore of storage area
DISK1:[USER]EMPIDS_LOW.RDA;1 at 18-JUN-1997 16:20:05.91
%RMU-I-RESTXT_21, Starting full restore of storage area
DISK1:[USER]DEPARTMENTS.RDA;1 at 18-JUN-1997 16:20:06.01
%RMU-I-RESTXT_24, Completed full restore of storage area
DISK1:[USER]EMPIDS_OVER.RDA;1 at 18-JUN-1997 16:20:06.24
.
.
.
%RMU-I-RESTXT_01, Initialized snapshot file
DISK1:[USER]DEPARTMENTS.SNP;1
%RMU-I-LOGINIFIL, contains 100 pages, each page
is 2 blocks long
%RMU-I-RESTXT_01, Initialized snapshot file
DISK1:[USER]EMPIDS_LOW.SNP;1
%RMU-I-LOGINIFIL, contains 100 pages, each page
is 2 blocks long
.
.
.
%RMU-I-AIJWASON, AIJ journaling was active when
the database was backed up
%RMU-I-AIJRECFUL, Recovery of the entire database
starts with AIJ file sequence 0
%RMU-I-AIJRECARE, Recovery of area DEPARTMENTS starts
with AIJ file sequence 0
%RMU-I-AIJRECARE, Recovery of area EMPIDS_LOW starts
with AIJ file sequence 0
%RMU-I-AIJRECARE, Recovery of area EMPIDS_MID starts
with AIJ file sequence 0
%RMU-I-AIJRECARE, Recovery of area EMPIDS_OVER starts
with AIJ file sequence 0
%RMU-I-AIJBADAREA, inconsistent storage area
DISK1:[USER]DEPARTMENTS.RDA;1 needs AIJ sequence number 0
%RMU-I-AIJBADAREA, inconsistent storage area
DISK1:[USER]EMPIDS_LOW.RDA;1 needs AIJ sequence number 0
.
.
.
```

1.43 RMU Restore Only_Root Command

```
%RMU-I-LOGRECDB, recovering database file
  DISK1:[USER]MF_PERSONNEL.RDB;1
%RMU-I-AIJAUTOREC, starting automatic after-image
  journal recovery
%RMU-I-LOGOPNAIJ, opened journal file DISK2:[CORP]AIJ_ONE.AIJ;1
%RMU-I-AIJONEDONE, AIJ file sequence 0 roll-forward
  operations completed
%RMU-I-LOGRECOVR, 1 transaction committed
%RMU-I-LOGRECOVR, 0 transactions rolled back
%RMU-I-LOGRECOVR, 2 transactions ignored
%RMU-I-AIJNOACTIVE, there are no active transactions
%RMU-I-AIJSUCCESS, database recovery completed successfully
%RMU-I-AIJALLDONE, after-image journal roll-forward
  operations completed
%RMU-I-LOGSUMMARY, total 1 transaction committed
%RMU-I-LOGSUMMARY, total 0 transactions rolled back
%RMU-I-LOGSUMMARY, total 2 transactions ignored
%RMU-I-AIJSUCCESS, database recovery completed successfully
%RMU-I-AIJGOODAREA, storage area
  DISK1:[USER]DEPARTMENTS.RDA;1 is now consistent
%RMU-I-AIJGOODAREA, storage area
  DISK1:[USER]EMPIDS_LOW.RDA;1 is now consistent
%RMU-I-AIJGOODAREA, storage area
  DISK1:[USER]EMPIDS_MID.RDA;1 is now consistent
  .
  .
  .
%RMU-I-AIJFNLSEQ, to start another AIJ file recovery,
  the sequence number needed will be 0
%RMU-I-COMPLETED, RESTORE operation completed at
  18-JUN-1997 16:20:11.45
$ !
$ ! The database is now restored and recovered. However, if
$ ! for some reason the automatic .aij file recovery was not
$ ! possible (for example, if you had backed up the .aij files),
$ ! apply the .aij files in the same order in
$ ! which they were created. That is, if .aij files were backed
$ ! up each night, apply aij_mon.aij first and aij_tues.aij second.
```

Example 7

The following example demonstrates the use of the Directory, File, and Root qualifiers. First, the database is backed up, then a couple storage area files and a snapshot file are moved. The restore-only-root operation does the following:

- The default directory is specified as DISK2:[DIR].
- The target directory and file name for the database root file is specified with the Root qualifier. The target directory specified with the Root qualifier overrides the default directory specified with the Directory

1.43 RMU Restore Only_Root Command

qualifier. Thus, the RMU Restore Only_Root process restores the database root in DISK3:[ROOT] and names it COPYRDB.RDB.

- The target directory for the EMPIDS_MID storage area is DISK4:[FILE]. The RMU Restore Only_Root process updates the database root file to indicate that EMPIDS_MID currently resides in DISK4:[FILE].
- The target for the EMPIDS_MID snapshot file is DISK5:[SNAP]EMPIDS_MID.SNP. Thus, the RMU Restore Only_Root process updates the database root file to indicate that the EMPIDS_MID snapshot file currently resides in DISK5:[SNAP]EMPIDS_MID.SNP.
- The target file name for the EMPIDS_LOW storage area is EMPIDS. Thus, the RMU Restore Only_Root process updates the database root file to indicate that the EMPIDS_LOW storage area currently resides in the DISK2 default directory (specified with the Directory qualifier), and the file is currently named EMPIDS.RDA.
- The target for the EMPIDS_LOW snapshot file is DISK5:[SNAP]EMPIDS.SNP. Thus, the RMU Restore Only_Root process updates the database root file to indicate that the EMPIDS_LOW snapshot file currently resides in DISK5:[SNAP]EMPIDS.SNP.
- Data for all the other storage area files and snapshot files remain unchanged in the database root file.

```
$ ! Back up the database:
$ !
$ RMU/BACKUP MF_PERSONNEL.RDB MF_PERSONNEL.RBF
$ !
$ ! Move a couple of storage areas and a snapshot file:
$ !
$ RMU/MOVE_AREA MF_PERSONNEL.RDB -
_ $ /DIRECTORY=DISK2:[DIR] -
_ $ EMPIDS_MID/FILE=DISK4:[FILE] -
_ $ /SNAPSHOT=(FILE=DISK3:[SNAP]EMPIDS_MID.SNP) , -
_ $ EMPIDS_LOW/FILE=EMPIDS -
_ $ /SNAPSHOT=(FILE=DISK5:[SNAP]EMPIDS.SNP)
$ !
$ ! Database root is lost. Restore the root and update the
$ ! locations of the moved storage areas and snapshot file as
$ ! recorded in the database root file because the locations
$ ! recorded in the backup file from which the root is restored
$ ! are not up-to-date:
$ !
```

1.43 RMU Restore Only_Root Command

```
$ RMU/RESTORE/ONLY_ROOT MF_PERSONNEL.RBF -  
_$_ /ROOT=DISK3:[ROOT]MF_PERSONNEL.RDB -  
_$_ EMPIDS_MID/FILE=DISK4:[FILE] -  
_$_ /SNAPSHOT=(FILE=DISK2:[DIR]EMPIDS_MID.SNP), -  
_$_ EMPIDS_LOW/FILE=DISK2:[DIR]EMPIDS -  
_$_ /SNAPSHOT=(FILE=DISK5:[SNAP]EMPIDS.SNP)
```

1.44 RMU Server After_Journal Reopen_Output Command

1.44 RMU Server After_Journal Reopen_Output Command

Allows you to close the current AIJ log server (ALS) output file for the specified database and open a new one. This allows you to see the current contents of the original ALS output file.

Format

RMU/Server After_Journal Reopen_Output root-file-spec

Description

The RMU Server After_Journal Reopen_Output command allows you to reopen an ALS output file that was previously created with an RMU Server After_Journal Start command with the Output qualifier. (The ALS output file is opened for exclusive access by the ALS process.)

Reopening the output file results in the current output file being closed and a new output file being created. The new output file has the same file name as the original output file, but its version number is incremented by one.

The ALS is an optional process that flushes log data to the after-image journal (.aij) file. All database servers deposit transaction log data in a cache located in the database global section. If the ALS is active, it continuously flushes the log data to disk. Otherwise, server processes might block temporarily if the cache in the global section is full.

Parameters

root-file-spec

Specifies the database root file for which you want to reopen the ALS output file.

Usage Notes

- To use the RMU Server After_Journal Reopen_Output command for a database, you must have RMU\$OPEN privilege in the root file access control list (ACL) for the database or the OpenVMS WORLD privilege.

1.44 RMU Server After_Journal Reopen_Output Command

- To issue the RMU Server After_Journal Reopen_Output command successfully, the database must be opened. Other users can be attached to the database when this command is issued.
- To determine whether the ALS is running, use the RMU Show Users command.

Examples

Example 1

In the following example the first Oracle RMU command starts the log server and specifies an output file. The second Oracle RMU command reopens the ALS output file, so you can view the data that is contained in the ALS output file so far.

```
$ RMU/SERVER AFTER_JOURNAL START MF_PERSONNEL/OUT=ALS
$ ! Database updates occur
$ RMU/SERVER AFTER_JOURNAL REOPEN_OUTPUT MF_PERSONNEL
$ ! View the ALS.OUT;-1 file:
$ TYPE ALS.OUT;-1
-----
16-OCT-1995 13:02:05.21 - Oracle Rdb V7.0-00 database utility started
-----
.
.
.
```

1.45 RMU Server After_Journal Start Command

1.45 RMU Server After_Journal Start Command

Allows you to manually start the AIJ log server (ALS) for the specified database and specify a file for the AIJ log server output.

Format

RMU/Server After_Journal Start root-file-spec

<u>Command Qualifier</u>	<u>Default</u>
/Output=file-spec	See description

Description

The ALS is an optional process that flushes log data to the after-image journal (.aij) file. All database servers deposit transaction log data in a cache located in the database global section. If the ALS is active, it continuously flushes the log data to disk. Otherwise, server processes might block temporarily if the cache in the global section is full. The ALS should be started only when AIJ processing is a bottleneck. Typically, multiuser databases with medium to high update activity can benefit from using the ALS.

You can start the ALS either manually, using the RMU Server After_Journal Start command, or automatically when the database is opened (by specifying LOG SERVER IS AUTOMATIC in the SQL ALTER DATABASE command). By default, the ALS startup is set to manual.

Command Parameters

root-file-spec

Specifies the database root file for which you want to start the ALS.

Command Qualifiers

Output=file-spec

Specifies the file for the ALS output file. Use this qualifier in anticipation of issuing an RMU Server After_Journal Reopen_Output command. By specifying the output file, you will know the location of, and therefore can view, the ALS output file.

By default, the ALS output file is not available to the user.

1.45 RMU Server After_Journal Start Command

Usage Notes

- To use the RMU Server After_Journal Start command for a database, you must have RMU\$OPEN privilege in the root file access control list (ACL) for the database or the OpenVMS WORLD privilege.
- The ALS can be started only if the database is open and if after-image journaling is enabled.
- The RMU Server After_Journal Start command can be issued while users are attached to the database.
- If the ALS process stops abnormally, regardless of whether the current setting of the ALS is automatic or manual, the only way to restart it is to use the RMU Server After_Journal Start command.
- To determine whether the ALS is running, use the RMU Show Users command.
- Any errors encountered when you try to start the ALS are logged in the monitor log file. Use the RMU Show System command to find the location of the monitor log file.

Examples

Example 1

The following Oracle RMU command starts the log server.

```
$ RMU/SERVER AFTER_JOURNAL START MF_PERSONNEL
```

1.46 RMU Server After_Journal Stop Command

1.46 RMU Server After_Journal Stop Command

Allows you to manually stop the AIJ log server (ALS) for the specified database.

Format

RMU/Server After_Journal Stop root-file-spec

Command Qualifiers Defaults

/Output=file-name See description

Description

The ALS is an optional process that flushes log data to the after-image journal (.aij) file. All database servers deposit transaction log data in a cache located in the database global section. If the ALS is active, it continuously flushes the log data to disk. Otherwise, server processes might block temporarily if the cache in the global section is full.

Command Parameters

root-file-spec

Specifies the database root file for which you want to stop the ALS.

Command Qualifiers

Output=file-name

Allows you to specify the file where the operational log is to be created. The operational log records the transmission and receipt of network messages.

If you do not include a directory specification with the file name, the log file is created in the database root file directory. It is invalid to include a node name as part of the file name specification.

Note that all Hot Standby bugcheck dumps are written to the corresponding bugcheck dump file; bugcheck dumps are not written to the file you specify with the Output qualifier.

1.46 RMU Server After_Journal Stop Command

Usage Notes

- To use the RMU Server After_Journal Stop command for a database, you must have RMU\$OPEN privilege in the root file access control list (ACL) for the database or the OpenVMS WORLD privilege.
- To issue the RMU Server After_Journal Stop command successfully, the database must be open. Other users can be attached to the database.
- If the ALS process stops abnormally, regardless of whether the current setting of the ALS is automatic or manual, the only way to restart it is to use the RMU Server After_Journal Start command.
- To determine whether the ALS is running, use the RMU Show Users command.
- If database replication is active and you attempt to stop the database AIJ log server, Oracle Rdb returns an error. You must stop database replication before attempting to stop the server.

Examples

Example 1

The following example stops the log server.

```
$ RMU/SERVER AFTER_JOURNAL STOP MF_PERSONNEL
```

1.47 RMU Server Backup_Journal Resume Command

1.47 RMU Server Backup_Journal Resume Command

Allows you to reinstate the ability to perform AIJ backup operations after they have been manually suspended with the RMU Server Backup_Journal Suspend command.

Format

RMU/Server Backup_Journal Resume root-file-spec

<u>Command Qualifiers</u>	<u>Defaults</u>
/[No]Log	Current DCL verify value

Description

When you issue the RMU Server Backup_Journal Suspend command, after-image journal (AIJ) backup operations are temporarily suspended. Use the RMU Server Backup_Journal Resume command to reinstate the ability to backup .aij files.

The RMU Server Backup_Journal Resume command must be issued from the same node from which AIJ backup operations were originally suspended. If you attempt to resume AIJ backup operations from another database node, the following errors are returned:

```
%RDMS-F-CANTRESUMEABS, error resuming AIJ backup operations
-RDMS-F-ABSNSUSPENDED, AIJ backup operations not suspended
%RMU-F-FATALRDB, Fatal error while accessing Oracle Rdb.
```

Command Parameters

root-file-spec

Specifies the database root file for which you want to resume AIJ backup operations.

Command Qualifiers

Log

Nolog

Specifies whether the processing of the command is reported to SYS\$OUTPUT. Specify the Log qualifier to request log output and the Nolog qualifier to prevent it. If you specify neither, the default is the current setting of the

1.47 RMU Server Backup_Journal Resume Command

DCL verify switch. (The DCL SET VERIFY command controls the DCL verify switch.)

Usage Notes

- To use the RMU Server Backup_Journal Resume command for a database, you must have RMU\$OPEN privilege in the root file access control list (ACL) for the database or the OpenVMS WORLD privilege.
- To determine whether AIJ backup operations have been suspended, use the RMU Show Users command.

Examples

Example 1

The following example demonstrates how to reinstate the ability to perform backup operations.

```
$ RMU/SERVER BACKUP_JOURNAL RESUME MF_PERSONNEL.RDB
```

1.48 RMU Server Backup_Journal Suspend Command

1.48 RMU Server Backup_Journal Suspend Command

Allows you to temporarily suspend .aij backup operations on all database nodes. While suspended, you cannot back up .aij files manually (with the RMU Backup After_Journal command) nor will the AIJ backup server (ABS) perform .aij backup operations.

Format

RMU/Server Backup_Journal Suspend root-file-spec

<u>Command Qualifiers</u>	<u>Default</u>
/[No]Log	Current DCL verify value

Description

When you issue the RMU Server Backup_Journal Suspend command, after-image journal (AIJ) backup operations are temporarily suspended. However, the suspended state is not stored in the database root file. Thus, if the node from which the AIJ backup operations were suspended fails, then AIJ backup operations by the AIJ Backup Server (ABS) are automatically resumed (assuming the ABS was running prior to the suspension).

The purpose of RMU Server Backup_Journal Suspend command is to temporarily suspend AIJ backup operations during a period of time when backing up .aij files would prevent subsequent commands from operating properly. For example, if you have a Hot Standby database, the time from when the master database is backed up to the time that database replication could commence might be long. During this period, .aij backup operations would prevent the replication from starting. (See the *Oracle Rdb7 and Oracle CODASYL DBMS: Guide to Hot Standby Databases* for information on Hot Standby databases.)

The solution to this problem is to use the RMU Server Backup_Journal Suspend command to suspend AIJ backups from the time just prior to beginning the database backup until after database replication commences.

AIJ backup operations are suspended until any of the following events occur:

- The database is closed on the node from which AIJ backup operations were suspended.
- The node fails from which AIJ backup operations were suspended.

1.48 RMU Server Backup_Journal Suspend Command

- Database replication is started on the node from which AIJ backup operations were suspended, as a master database.
- AIJ backup operations are explicitly resumed on the node from which AIJ backup operations were suspended. (This occurs when you issue the RMU Server Backup_Journal Resume command. See Section 1.47 for details.)

Command Parameters

root-file-spec

Specifies the database root file for which you want to suspend AIJ backup operations.

Command Qualifiers

Log

Nolog

Specifies whether the processing of the command is reported to SYS\$OUTPUT. Specify the Log qualifier to request log output and the Nolog qualifier to prevent it. If you specify neither, the default is the current setting of the DCL verify switch. (The DCL SET VERIFY command controls the DCL verify switch.)

Usage Notes

- To use the RMU Server Backup_Journal Suspend command for a database, you must have RMU\$OPEN privilege in the root file access control list (ACL) for the database or the OpenVMS WORLD privilege.
- To determine whether AIJ backup operations have been suspended, use the RMU Show Users command.

Examples

Example 1

The following example first suspends .aij backup operations, then issues the RMU Show Users command to confirm that suspension has occurred. If you attempt an .aij backup operation, you receive the %RMU-F-LCKCNFLCT error message.

1.48 RMU Server Backup_Journal Suspend Command

```
$ RMU/SERVER BACKUP_JOURNAL SUSPEND MF_PERSONNEL.RDB
$ RMU/SHOW USERS MF_PERSONNEL.RDB
. . .
  * After-image backup operations temporarily suspended
    from this node
. . .
$ RMU/BACKUP/AFTER_JOURNAL MF_PERSONNEL.RDB AIJ_BACKUP.AIJ
%RMU-F-LCKCNFLCT, lock conflict on AIJ backup
```

1.49 RMU Server Record_Cache Checkpoint Command

1.49 RMU Server Record_Cache Checkpoint Command

Allows the database administrator to force the Record Cache Server (RCS) process to checkpoint all modified rows from cache back to the database.

Format

RMU/Server Record_Cache Checkpoint root-file-spec

<u>Command Qualifier</u>	<u>Defaults</u>
/[No]Log	Current DCL verify value
/[No]Wait	/NoWait

Description

When you use row caches, it is possible for a large number of database records to be modified in row cache areas. These modified records must be written to the physical database files on disk at various times, such as backing up or verifying the database, or when closing the database. The RMU Server Record_Cache Checkpoint command causes the RCS process to immediately write all modified records from all row cache areas back to the physical database files on disk.

If there are a large number of modified records to be written back to the database, this operation can take a long time.

Command Parameters

root-file-spec

Specifies the database root file for which you want to checkpoint all modified rows.

Command Qualifiers

Log

Nolog

Specifies whether the processing of the command is reported to SYS\$OUTPUT. Specify the Log qualifier to request log output and the Nolog qualifier to prevent it. If you specify neither, the default is the current setting of the DCL verify switch. (The DCL SET VERIFY command controls the DCL verify switch.)

1.49 RMU Server Record_Cache Checkpoint Command

Wait

Nowait

Specifies whether the Oracle RMU operation completes right away (**Nowait**) or whether RMU waits for the record cache server to complete the checkpoint before returning to the user. The default is **Nowait**.

1.50 RMU Set After_Journal Command

1.50 RMU Set After_Journal Command

Allows you to do any of the following with respect to after-image journal (.aij) files:

- Enable or disable after-image journaling.
- Alter an .aij file (occurs only if .aij file is re-created).
- Add, drop, modify, or reserve .aij files.
- Suppress the use of an .aij file.
- Add AIJ caches.
- Set the initial .aij file allocation.
- Set the .aij file extent (for extensible journals).
- Enable or disable .aij file overwriting.
- Send OpenVMS operator communication manager (OPCOM) messages when specific after-image journal events occur.
- Set the shutdown timeout period.

Note

Prior to Oracle Rdb Version 6.0, the ability to alter an .aij file name was provided through the RdbALTER DEPOSIT ROOT command. Beginning with Oracle Rdb Version 6.0, the RdbALTER DEPOSIT ROOT command no longer provides this capability; use the Alter qualifier with the RMU Set After_Journal command instead.

1.50 RMU Set After_Journal Command

Format

RMU/Set After_Journal root-file-spec

Command Qualifiers

/Add=(keyword[,...])
/Aij_Options=OptionsFile
/Allocation=number-blocks
/Alter=(keyword[,...])
/Backups=(keyword_list)
/[No]Cache=file
/Disable
/Drop=(Name=name)
/Enable
/Extent=number-blocks
/[No]Log
/[No]Notify=(operator-class-list)
/[No]Overwrite
/Reserve=number-journals
/Shutdown_Timeout=minutes
/Suppress=(Name=name)
/Switch_Journal

Defaults

No journals added
None
See description
No journals altered
See description
See description
None
No journals deleted
None
See description
Current DCL verify value
See description
None
None
60 minutes
No journals suppressed
None

Description

Many of the RMU Set After_Journal functions are also available through the use of the following SQL ALTER DATABASE clauses:

ADD JOURNAL clause
DROP JOURNAL clause
ALTER JOURNAL clause

Command Parameters

root-file-spec

Specifies the database root file for which you want to enable journaling or set .aij file characteristics.

Command Qualifiers

Add=(keyword, ...)

Adds an .aij file to the after-image journal file configuration. You can add an .aij file while users are attached to the database. If you specify the Suppress, Drop, or Alter qualifiers in the same RMU Set After_Journal command, they

1.50 RMU Set After_Journal Command

are processed before the Add qualifier. The Add qualifier can appear several times in the same command.

Specify an .aij file to add by using the following keywords:

- **Name=name**
Specifies a unique name for the after-image journal object to be added. An after-image journal object is the .aij file specification plus all of its attributes, such as allocation, extent, and backup file name.
This keyword is required.
- **File=file**
Specifies the file for the journal to be added. This keyword is required. If you do not provide a full file specification, and only the file name, the file is placed in your current directory. If more than one journal resides in the same directory, each journal must have a unique file name. However, each fixed-size journal file should be located on a separate device. This minimizes risks associated with journal loss or unavailability should a device fail or be brought off line. For example, if two or more journal files reside on the same failed device, the loss of information or its unavailability is far greater than that of a single journal file.
- **Backup_File=file**
Specifies the file to be used for automatic backup operations. This keyword is optional. If you specify a file name, but not a file extension, the .aij file extension is used by default. If you supply only a file name (not a complete file specification), the backed up .aij file is placed in the database root file directory.
- **Edit_Filename=(option)**
Specifies an edit string to apply to the backup file when an .aij is backed up automatically. This keyword is optional. However, if it is specified, the Backup_File=file keyword must be specified also. When you specify the Edit_Filename=(options) keyword, the .aij backup file name is modified by appending the options you specify.
See the description of the Edit_Filename keyword for the Backups qualifier for a list of the available keyword options.
This keyword and the options you specify affect the backup file name of the .aij file specified with the associated Name keyword only. If you want the same edit string applied to all backed up .aij files, you might find it more efficient to use the Backups qualifier with the Edit_Filename keyword instead of the Add qualifier with the Edit_Filename keyword.

1.50 RMU Set After_Journal Command

If you use a combination of the `Edit_Filename` keyword with the `Add` qualifier and the `Edit_Filename` keyword with the `Backups` qualifier, the `Add` qualifier keyword takes precedence over the `Backups` qualifier keyword for the named `.ajj` file. In other words, the options you specify with `Edit_Filename` keyword to the `Backups` qualifier are applied to all backed up `.ajj` files except those for which you explicitly specify the `Edit_Filename` keyword with the `Add` qualifier. See Example 6.

This keyword is useful for creating meaningful file names for your backup files and makes file management easier.

- **Allocation=number-blocks**

Sets the initial size, in disk blocks, of the `.ajj` file. If this keyword is omitted, the default allocation is used. The minimum valid value is 512, the maximum value is eight million. The default is 512.

See the *Oracle Rdb Guide to Database Maintenance* for guidance on setting the allocation size.

- **Extent=number-blocks**

Specifies the maximum size to extend an `.ajj` file if it is, or becomes, an extensible `.ajj` file (in blocks). (If the number of available after-image journal files falls to one, extensible journaling is employed.)

If there is insufficient free space on the `.ajj` file device, the journal is extended using a smaller extension value than specified. However, the minimum, and default, extension size is 512 blocks.

See the *Oracle Rdb Guide to Database Maintenance* for guidance on setting the extent size.

AIJ_Options=OptionsFile

Specifies an options file name. The default extension is `.opt`. The `OptionsFile` is the same as that generated by an `RMU Show After_Journal` command and is also used by the `RMU Copy_Database`, `Move_Area`, `Restore`, and `Restore Only_Root` commands. The `AIJ_Options` qualifier may be used alone or in combination with other `RMU Set After_Journal` command qualifiers.

Allocation=number-blocks

Sets the default `.ajj` file allocation. You can change the allocation while users are attached to the database. If the `Allocation` qualifier is omitted, the default allocation is unchanged.

The minimum value you can specify is 512. The default is also 512.

See the *Oracle Rdb Guide to Database Maintenance* for guidance on setting the allocation size.

1.50 RMU Set After_Journal Command

Alter=(keyword,...)

Specifies that an after-image journal object be altered.

You can alter an after-image journal object while users are attached to the database. The Alter qualifier can be used several times within the same RMU Set After_Journal command. If you specify a previously suppressed .aij file with the Alter qualifier, that named .aij file is unsuppressed. Oracle RMU performs this unsuppress action as soon as the command is processed.

The changes specified by the Alter qualifier are stored in the database root file (and thus are visible in the dump file if you issue an RMU Dump command), but the changes are not applied to the .aij file until it is re-created (or backed up, in the case of the Backup_File= file keyword). A new extensible .aij file is re-created, for example, when the following are true:

- Fast commit is enabled.
- Extensible after-image journaling is being used.
- Users are actively updating the database.
- You issue an RMU Backup After_Journal command with the Noquiet_Point qualifier.

Backing up an extensible .aij file does not ensure that a new .aij file will be created. In most cases, the existing .aij file is truncated and reused.

Specify an after-image journal object to alter by using the following keywords:

- Name=name

Specifies the name of the after-image journal object. This is a required keyword that must match the name of an existing after-image journal object.

- File=file

This option only takes effect if a journal is, or becomes, an extensible .aij file and only when that journal is re-created. This option allows you to supply a new .aij file specification to be used for the extensible .aij file if and when it is re-created. This can be used to move the re-created .aij file to a new location. If you do not provide a full file specification, and only the file name, the file is placed in your current directory. See the general description of the Alter qualifier for an example of when an extensible .aij file is re-created.

This option cannot be used to move a fixed-size .aij file. To move a fixed-size .aij file, you must first create a new .aij file and then drop the existing .aij file.

This keyword is optional.

1.50 RMU Set After_Journal Command

- **Backup_File=file**
Specifies a new file to be used for automatic backup operations.
This keyword is optional.
- **Edit_Filename=(options)**
Specifies a new edit string to apply to the backup file name of the named .aij file when the .aij is backed up automatically. This keyword is optional. See the description of the Edit_Filename keyword for the Backups qualifier for a list of the available keyword options.
- **Allocation=number-blocks**
Specifies the initial size of the .aij file that is re-created if that file is, or becomes, a fixed-size .aij file.
- **Extent=number-blocks**
Specifies the extent size of the .aij file that is re-created if it is, or becomes, extensible.

See the *Oracle Rdb Guide to Database Maintenance* for guidance on setting the extent size.

Backups=(keyword_list)

Specifies options to control the AIJ backup server. You can select one or more of the following keywords:

- **Automatic**
Specifies that the AIJ backup server will run automatically, as required. You cannot specify both the Automatic and Manual keywords. If neither the Automatic nor the Manual keyword is specified, the backup server state is unchanged.
- **Manual**
Specifies that the RMU Backup After_Journal command will be used to back up the .aij files. The AIJ backup server will not run automatically. You cannot specify both Automatic and Manual keywords. If neither the Automatic nor the Manual keyword is specified, the backup server state is unchanged.
- **Backup_File=file**
Specifies a default file specification for the AIJ backup server to use as the backup file name if no backup file name is associated with the .aij file to be backed up.

1.50 RMU Set After_Journal Command

- **Nobackup_File**
Specifies that there is no default backup file specification. Omission of this keyword retains the current default backup file specification.
- **Edit_Filename=(options)**
The **Edit_Filename** keyword specifies an edit string to apply to .aij files when they are backed up automatically. When the **Edit_Filename=(options)** keyword is used, the .aij backup file names are edited by appending any or all of the values specified by the following options to the backup file name:
 - **Day_Of_Year**
The current day of the year expressed as a 3-digit integer (001 to 366).
 - **Day_Of_Month**
The current day of the month expressed as a 2-digit integer (01 to 31).
 - **Hour**
The current hour of the day expressed as a 2-digit integer (00 to 23).
 - **Julian_Date**
The number of days passed since 17-Nov-1858.
 - **Minute**
The current minute of the hour expressed as a 2-digit integer (00 to 59).
 - **Month**
The current month expressed as a 2-digit integer (01 to 12).
 - **Sequence**
The journal sequence number of the first journal in the backup operation.
 - **Vno**
Synonymous with the **Sequence** option. See the description of the **Sequence** option.
 - **Year**
The current year (A.D.) expressed as a 4-digit integer.If you specify more than one option, place a comma between each option.

1.50 RMU Set After_Journal Command

The edit is performed in the order specified. For example, the file backup.ajj and the keyword EDIT_FILENAME=(HOUR, MINUTE, MONTH, DAY_OF_MONTH, SEQUENCE) creates a file with the name backup_160504233.ajj when journal 3 is backed up at 4:05 P.M. on April 23rd.

You can make the name more readable by inserting quoted strings between each Edit_Filename option. For example, the option shown in the following code adds the string "\$30_0155-2" to the .ajj file name if the day of the month is the 30th, the time is 1:55 and the version number is 2:

```
/EDIT_FILENAME=( "$", DAY_OF_MONTH, "_", HOUR, MINUTE, "-", SEQUENCE)
```

This keyword is useful for creating meaningful file names for your backup files and makes file management easier.

If you use a combination of the Edit_Filename keyword with the Add qualifier and the Edit_Filename keyword with the Backups qualifier, the Add qualifier keyword takes precedence over the Backups qualifier keyword for the named .ajj file. In other words, the options you specify with Edit_Filename keyword to the Backups qualifier are applied to all .ajj back up files except those for which you explicitly specify the Edit_Filename keyword with the Add qualifier. See Example 6.

- **Quiet_Point**
Specifies that the after-image journal backup operation is to acquire the quiet-point lock prior to performing an .ajj backup operation for the specified database. This option (as with all the other Backup options) affects only the database specified in the RMU Set After_Journal command line. For information on specifying that the quiet-point lock be acquired before any .ajj backup operation is performed on a system, see the Usage Notes.
- **Noquiet_Point**
Specifies that the after-image journal backup operation will not acquire the quiet-point lock prior to performing an .ajj backup operation for the specified database. This option (as with all the other Backup options) affects only the database specified in the RMU Set After_Journal command line. For information on specifying that the quiet-point lock will not be acquired prior to any .ajj backup operations performed on a system, see the Usage Notes.

1.50 RMU Set After_Journal Command

Cache=file

Nocache

Specifies an after-image journal cache file specification on a solid-state disk. If the Cache qualifier is specified, after-image journal caches are enabled. If you specify a file name, but not a file extension, the file extension .aij is used by default.

If the Nocache qualifier is specified, AIJ caches are disabled. You can use this qualifier only when users are detached from the database.

This file must be written to a solid-state disk. If a solid-state disk is not available, after-image journal caching should not be used. Unless you are involved in a high performance, high-volume environment, you probably do not need the features provided by this qualifier.

You can determine whether the cache file is accessible by executing the RMU Dump command with the Header qualifier. If caching is enabled, but the cache file is unavailable, the cache file is marked inaccessible and after-image journaling continues as if caching was disabled. Once the cache file has been marked inaccessible, it will remain so marked until either the existing cache file is dropped from the database, or a new cache file is added to the database (even if this is the same cache file as was previously used).

If this qualifier is omitted, the AIJ cache state remains unchanged.

Disable

Disables after-image journaling if it has already been enabled. If after-image journaling has already been disabled, this qualifier has no effect. You can specify the Disable qualifier only when users are detached from the database.

When the Disable qualifier and other qualifiers are specified with the RMU Set After_Journal command, after-image journaling is disabled before other requested operations.

There is no default for the Disable qualifier. If you do not specify either the Disable or Enable qualifier, the after-image journaling state remains unchanged.

Drop=(Name=name)

Specifies that the named after-image journal object be deleted. You can drop an after-image journal object while users are attached to the database, but the named after-image journal object must not be the current .aij file or be waiting to be backed up. When the Drop qualifier is specified with the Alter or Add qualifiers on the RMU Set After_Journal command, the named after-image journal object is dropped before any after-image journal objects are altered or added.

1.50 RMU Set After_Journal Command

Each after-image journal object to be deleted is specified by the required keyword, `Name=name`. This specifies the name of the after-image journal object to be dropped, which must match the name of an existing after-image journal object.

Enable

Enables after-image journaling if it has been disabled. You can specify the `Enable` qualifier only when users are detached from the database and at least one unmodified `.aj` file is available (unless you also specify the `Overwrite` qualifier). After-image journaling is enabled after other specified qualifiers have been processed.

Extent=number-blocks

Sets the size, in blocks, of the default `.aj` file extension. This qualifier has no effect on fixed-length `.aj` files. This qualifier can be used while users are attached to the database.

The minimum valid `number-blocks` value is 512. The default is also 512.

If the `Extent` qualifier is omitted, the default extension remains unchanged.

See the *Oracle Rdb Guide to Database Maintenance* for guidance on setting the extent size.

Log

Nolog

Specifies whether the processing of the command is reported to `SYS$OUTPUT`. Specify the `Log` qualifier to request log output and the `Nolog` qualifier to prevent it. If you specify neither, the default is the current setting of the `DCL verify` switch. (The `DCL SET VERIFY` command controls the `DCL verify` switch.)

Notify=(operator-class-list)

Nonotify

Sets the operator notification state for after-image journaling and selects the operators to be notified when the journaling state changes. Oracle RMU uses the OpenVMS operator communication manager (OPCOM). The following events evoke operator notification:

- An error writing to an `.aj` file.
- No `.aj` file is available for write operations.
- The `.aj` file has been overwritten.
- The RMU Backup `After_Journal` command fails.

1.50 RMU Set After_Journal Command

You can use this qualifier while users are attached to the database. If you specify the Nonotify qualifier, operator notification is disabled. If the qualifier is omitted, the operator notification state is unchanged.

The operator classes follow:

- [No]All
The All operator class broadcasts a message to all terminals that are attached to the system or cluster. These terminals must be turned on and have broadcast-message reception enabled. The Noall operator class inhibits the display of messages to the entire system or cluster.
- [No]Central
The Central operator class broadcasts messages to the central system operator. The Nocentral operator class inhibits the display of messages to the central system operator.
- [No]Disks
The Disks operator class broadcasts messages pertaining to mounting and dismounting disk volumes. The Nodisks operator class inhibits the display of messages pertaining to mounting and dismounting disk volumes.
- [No]Cluster
The Cluster operator class broadcasts messages from the connection manager pertaining to cluster state changes. The Nocluster operator class inhibits the display of messages from the connection manager pertaining to cluster state changes.
- [No]Security
The Security operator class displays messages pertaining to security events. The Nosecurity operator class inhibits the display of messages pertaining to security events.
- [No]Oper1 through [No]Oper12
The Oper1 through Oper12 operator classes display messages to operators identified as OPER1 through OPER12. The Nooper1 through Nooper12 operator classes inhibit messages from being sent to the specified operator.

Note

Use the Notify qualifier conservatively. Be sure that messages regarding a private database are not broadcast to an entire system or cluster of users who may not be interested in the broadcast information.

1.50 RMU Set After_Journal Command

Similarly, be conservative regarding even a clusterwide database. You do not want to overload the operators with insignificant messages.

Overwrite

Nooverwrite

The Overwrite qualifier specifies that .ajj files can be overwritten without first being backed up. The Nooverwrite qualifier specifies that only an .ajj file that has been backed up can be overwritten. You can specify the Nooverwrite qualifier only when users are detached from the database. If you do not specify either the Overwrite qualifier or the Nooverwrite qualifier, the Overwrite characteristic remains unchanged.

This qualifier is ignored if only one .ajj file is available. When you specify the Overwrite qualifier, it is only activated when two or more .ajj files are, or become, available.

Note that if you use the Overwrite qualifier, you will be unable to perform a rollforward from a restored backup file. Most users will not want to use the Overwrite qualifier; it is provided for layered applications that might want to take advantage of some performance features provided by Oracle Rdb that require after-image journaling, but where the use of after-image journaling is not required for the application to run reliably.

Reserve=number-journals

Reserves additional space in the after-image journal configuration for the specified number of .ajj files. You can specify the Reserve qualifier only when users are detached from the database. If you do not specify the Reserve qualifier, no space is reserved for additional .ajj files.

Note that you cannot reserve space in a single-file database for .ajj files by using this qualifier with the RMU Set After_Journal command. After-image journal file reservations for a single-file database can be made only when you use the RMU Convert, RMU Restore, or RMU Copy_Database commands.

Note that once you reserve space in the journal configuration (using the Reserve=n qualifier), the reservations are permanent. There is no way to unreserve this space unless you back up and restore the database. Specify fewer reservations with RMU Restore command After_Journal qualifier.

Each reservation uses two blocks of space in the root file and the run-time global sections.

When you reserve journals slots to create additional journals for your journal system, the reserve operation is not journaled. Therefore, you should perform a full database backup operation to ensure database consistency.

1.50 RMU Set After_Journal Command

Shutdown_Timeout=minutes

Modifies the after-image journal shutdown time in the event that after-image journaling becomes unavailable. The after-image journaling shutdown time is the period, in minutes, between the point when after-image journaling becomes unavailable and the point when the database is shut down. During the after-image journaling shutdown period, all database update activity is stalled.

If operator notification has been enabled, operator messages are broadcast to all enabled operator classes and to the RMU Show Statistics screen at 1-minute intervals.

To recover from the after-image journaling shutdown state and to resume normal database operations, you must make an .aij file available for use. You can do this by backing up an existing modified journal, or, if you have a journal reservation available, by adding a new journal to the after-image journaling configuration. If you do not make a journal available before the after-image journal shutdown time expires, the database is shut down and all active database attaches are terminated.

The after-image journaling shutdown period is only in effect when fixed-size AIJ journaling is used. When a single extensible .aij file is used, the default action is to shut down all database operations when the .aij file becomes unavailable.

If you do not specify the Shutdown_Timeout qualifier, the database shuts down 60 minutes after the after-image journaling configuration becomes unavailable. The maximum value you can specify for the Shutdown_Timeout qualifier is 4320 minutes (3 days).

Suppress=(Name=name)

Prevents further use of the named after-image journal object. The named after-image journal object must be an existing after-image journal object.

This qualifier is useful when you want to temporarily disallow the use of an .aij file. For example, suppose the disk containing the next .aij file to use goes off line. You do not want the database to attempt to access that file until the disk is back on line. Use the Suppress qualifier so the database does not attempt to access the specified .aij file. When the disk is back on line, use the RMU Set After_Journal command with the Alter qualifier to unsuppress the after-image journal object that references this .aij file.

1.50 RMU Set After_Journal Command

You can specify the Suppress qualifier while users are attached to the database, but the .aij file referenced by the after-image journal object must not be the current journal or be waiting to be backed up. You must back up the referenced .aij file before the after-image journal object that references it can be suppressed.

The Suppress qualifier is processed prior to any Drop, Add, or Alter qualifiers specified with the same command.

Switch_Journal

Changes the currently active .aij file to the next available .aij file in a fixed-size after-image journaling configuration.

In an extensible journal file configuration, the Switch_Journal qualifier has no effect and is ignored if specified.

The Switch_Journal qualifier is useful for forcing a switch to an .aij file on another disk when you want to perform maintenance on the disk containing the currently active journal file.

You cannot specify the Switch_Journal qualifier and the Enable or the Disable qualifier on the same command line. In addition, after-image journaling must be enabled when you issue the Switch_Journal qualifier.

It is seldom necessary to specify this option because normally a switch occurs automatically.

Usage Notes

- You must have the RMU\$ALTER, RMU\$BACKUP, or RMU\$RESTORE privilege in the root file access control list (ACL) for the database or the OpenVMS SYSPRV or BYPASS privilege to use the RMU Set After_Journal command.
- Use the RMU Dump command with the Header qualifier to see if after-image journaling additions or changes you have made have been recorded as you expect. However, note that although the AIJ attributes change as you specify, the changed .aij file might be flagged as unmodified in the dump of the header. This occurs because the transaction containing your changes to the .aij file is captured in the current .aij file, not the .aij file for which you specified modifications.

1.50 RMU Set After_Journal Command

- When you use RMU Set After_Journal to specify a fixed-size journal configuration, specify a different disk for each .aij file, if possible. Using this method, you can suppress a journal on a given disk if that disk should start to fail.
- If the disk fails on which the current .aij file resides, Oracle Rdb immediately starts using a new .aij file if your journal configuration contains more than one journal. For example, if AIJ_DISK1 contains AIJ_ONE, the current .aij file, and AIJ_DISK1 fails, Oracle Rdb will immediately start using AIJ_TWO, the .aij file on AIJ_DISK2.
- Execute a full database backup operation after issuing an RMU Set After_Journal command that displays the RMU-W-DOFULLBCK warning message (such as a command that includes the Reserve or the Enable qualifier).
- Use the Alter qualifier to unsuppress an .aij file that has been suppressed with the Suppress qualifier.
- Use the Backup=(Quiet_Point) qualifier to specify that the quiet-point lock must be acquired prior to performing an .aij backup operation for the *specified database*. (Use the Backup=(Noquiet_Point) qualifier to specify that the quiet-point lock will not be acquired prior to an .aij backup operation for the specified database.)
- Use the RDM\$BIND_ABS_QUIET_POINT logical to specify whether or not the quiet-point lock must be acquired prior to performing any .aij backup operation on *any database* on a cluster.

Define the value for the logical to be 1 to specify that the quiet-point lock must be acquired prior to performing .aij backup operations; define the value to be 0 to specify that the quiet-point lock need not be acquired prior to .aij backup operations. You must define this logical in the system table on all nodes in the cluster as shown in the following example:

```
$ DEFINE/SYSTEM RDM$BIND_ABS_QUIET_POINT 1
```

- The selection of which journal in a set of fixed-size journal files is used by Oracle RMU is unpredictable and depends on availability. For example, while a journal is temporarily unavailable, it cannot be selected as the next journal file. Thus, a journal file might be reused before all journals in the set have been used once.

1.50 RMU Set After_Journal Command

Examples

Example 1

The following command reserves space for three .aij files, adds two .aij files to the mf_personnel database, and then enables after-image journaling:

```
$ RMU/SET AFTER_JOURNAL/ENABLE/RESERVE=3 -
_$_ /ADD=(NAME=AIJ2, FILE=DISK1:[JOURNAL]AIJ_TWO) -
_$_ /ADD=(NAME=AIJ3, FILE=DISK2:[JOURNAL]AIJ_THREE) -
_$_ MF_PERSONNEL
%RMU-W-DOFULLBCK, full database backup should be done to
ensure future recovery
```

Example 2

The following example demonstrates how to switch the current .aij file from DISK1:[DB]AIJ1 to the next available journal file in a fixed-size journal configuration, and then suppress the original journal in anticipation of maintenance on the disk that contains it. The last Oracle RMU command moves AIJ1 to a new disk and implicitly unsuppresses it.

```
$ RMU/DUMP/HEADER=(JOURNAL) MF_PERSONNEL
.
.
.
AIJ Journaling...
- After-image journaling is enabled
- Database is configured for 5 journals
- Reserved journal count is 5
- Available journal count is 3
- Journal switches to next available when full
- 1 journal has been modified with transaction data
- 2 journals can be created while database is active
- Journal "AIJ1" is current
- All journals are accessible
.
.
.
$ RMU/SET AFTER_JOURNAL/SWITCH_JOURNAL MF_PERSONNEL/LOG
%RMU-I-OPERNOTIFY, system operator notification: Oracle Rdb Database
USER1:[DB]MF_PERSONNEL.RDB;1 Event Notification
After-image journal 0 switch-over in progress (to 1)
%RMU-I-OPERNOTIFY, system operator notification: Oracle Rdb Database
USER1:[DB]MF_PERSONNEL.RDB;1 Event Notification
After-image journal switch-over complete
%RMU-I-LOGMODSTR, switching to after-image journal "AIJ2"
```

1.50 RMU Set After_Journal Command

```
.  
. .  
$ RMU/BACKUP/AFTER_JOURNAL MF_PERSONNEL DISK1:[DB]AIJ1_BCK/LOG  
%RMU-I-AIJBCKBEG, beginning after-image journal backup operation  
%RMU-I-OPERNOTIFY, system operator notification: Oracle Rdb Database  
  USER1:[DB]MF_PERSONNEL.RDB;1 Event Notification  
AIJ backup operation started  
%RMU-I-AIJBCKSEQ, backing up after-image journal sequence number 2  
%RMU-I-LOGBCKAIJ, backing up after-image journal AIJ1 at 10:59:58.83  
%RMU-I-LOGCREBCK, created backup file DISK1:[DB]AIJ1_BCK.AIJ;1  
%RMU-I-OPERNOTIFY, system operator notification: Oracle Rdb Database  
  USER1:[DB]MF_PERSONNEL.RDB;1 Event Notification  
AIJ backup operation completed  
  
%RMU-I-AIJBCKEND, after-image journal backup operation completed  
  successfully  
%RMU-I-LOGAIJJRN, backed up 1 after-image journal at 11:00:02.59  
%RMU-I-LOGAIJBLK, backed up 254 after-image journal blocks  
  at 11:00:02.59  
$ RMU/SET AFTER_JOURNAL/SUPPRESS=(NAME=AIJ1) MF_PERSONNEL/LOG  
%RMU-I-LOGMODSTR,      suppressed after-image journal "AIJ1"  
$ RMU/SET AFTER_JOURNAL MF_PERSONNEL -  
  _$ /ALTER=(NAME=AIJ1,FILE=DISK2:[DB]AIJ1)/LOG  
%RMU-I-LOGMODSTR,      unsuppressed after-image journal "AIJ1"
```

1.50 RMU Set After_Journal Command

Example 3

The following example turns on the automatic backup server for .aij files and defines a default backup file name:

```
$ RMU/SET AFTER_JOURNAL /BACKUPS=(AUTOMATIC, -
_ $ BACKUP_FILE=DISK:[AIJ_BACKUPS]AIJ_BACKUP.AIJ) -
_ $ DB$DISK:[DIRECTORY]MF_PERSONNEL.RDB
```

Example 4

The following example turns off the automatic backup server for .aij files and removes the default backup file name:

```
$ RMU/SET AFTER_JOURNAL /BACKUPS=(MANUAL,NOBACKUP_FILE) -
_ $ DB$DISK:[DIRECTORY]MF_PERSONNEL.RDB
```

Example 5

The following example changes the .aij backup file name without changing the setting of the AIJ backup server:

```
$ RMU/SET AFTER_JOURNAL /BACKUPS= -
_ $ (BACKUP_FILE=NEW_DISK:[AIJ_BACKUPS]BETTER_BACKUP_NAME.AIJ) -
_ $ DB$DISK:[DIRECTORY]MF_PERSONNEL.RDB
```

Example 6

The following example sets a local and a global edit string for .aij backup files. When AIJ_ONE is backed up, it is appended with the string _LOCAL. When AIJ_TWO or AIJ_THREE are backed up, they are appended with the string _GLOBAL. Although it is unlikely that you would select these edit strings, they demonstrate the behavior of the Edit_Filename keyword when it is used with the Backup qualifier (global effect) versus the behavior of the Edit_Filename keyword when it is used with the Add qualifier (local effect).

```
$ RMU/SET AFTER_JOURNAL/ENABLE/RESERVE=5 -
_ $ /BACKUP=EDIT_FILENAME=("_GLOBAL")/ADD=(NAME=AIJ1, -
_ $ FILE=DISK1:[AIJS]AIJ_ONE, -
_ $ BACKUP_FILE=AIJ1BCK, -
_ $ EDIT_FILENAME=("_LOCAL")) -
_ $ /ADD=(NAME=AIJ2, -
_ $ FILE=DISK1:[AIJS]AIJ_TWO, -
_ $ BACKUP_FILE=AIJ2BCK) -
_ $ /ADD=(NAME=AIJ3, -
_ $ FILE=DISK1:[AIJS]AIJ_THREE, -
_ $ BACKUP_FILE=AIJ3BCK) -
_ $ MF_PERSONNEL
```

1.50 RMU Set After_Journal Command

```
$ !  
$ ! After these .aij files are backed up:  
$ !  
$ DIR .AIJ  
AIJ1BCK_LOCAL.AIJ;1  
AIJ2BCK_GLOBAL.AIJ;1  
AIJ3BCK_GLOBAL.AIJ;1  
AIJ_ONE.AIJ;1  
AIJ_THREE.AIJ;1  
AIJ_TWO.AIJ;1
```

1.51 RMU Set Audit Command

Enables Oracle Rdb security auditing. When security auditing is enabled, Oracle Rdb sends security alarm messages to terminals that have been enabled as security operators and makes entries in the database's security audit journal whenever specified audit events are detected.

Format

RMU/Set Audit root-file-spec

Command Qualifiers

/Disable=enable-disable-options
 /Enable=enable-disable-options
 /[No]Every
 /First
 /[No]Flush
 /Start
 /Stop
 /Type={Alarm|Audit}

Defaults

See description
 See description
 /Every
 Synonym for /Noevery
 /Noflush
 See description
 See description
 Alarm and Audit

Description

The RMU Set Audit command is the Oracle Rdb equivalent to the DCL SET AUDIT command. Because Oracle Rdb security auditing uses many OpenVMS system-level auditing mechanisms, certain auditing characteristics (such as /FAILURE_MODE) can only be set and modified by using the DCL SET AUDIT command, which requires the OpenVMS SECURITY privilege.

Command Parameters

root-file-spec

The file specification of the database root for which auditing information will be modified.

Command Qualifiers

Disable=enable-disable-options

Disables security auditing for the specified audit event classes. To disable alarms and audits for all classes, specify the All option. You can also selectively disable alarms and audits for one or more classes that are currently enabled. You must specify at least one class when you specify the Disable qualifier. See

1.51 RMU Set Audit Command

the Enable qualifier description for a list of the classes you can specify with the Disable qualifier.

When you specify audit classes with the Disable qualifier, the events you specify are immediately disabled. For other audit events that have not been explicitly disabled with the Disable qualifier, records continue to be recorded in the security audit journal and alarms continue to be sent to security-enabled terminals, as specified.

When processing the RMU Set Audit command, Oracle Rdb processes the Disable qualifier last. If you accidentally specify both Enable and Disable for the same event type in the same command, the Disable qualifier prevails.

Enable=enable-disable-options

Enables security auditing for the specified audit event classes. To enable alarms and audits for all events, specify the All option. You can also selectively enable alarms and audits for one or more classes that are currently disabled. You must specify at least one class when you specify the Enable qualifier.

When you specify audit classes with the Enable qualifier, the audit events you specify are immediately enabled, so that audit events of currently attached users are recorded in the security audit journal and alarms are sent to security-enabled terminals, as specified.

With the Enable and Disable qualifiers, you can specify one or more of the following six valid class options: All, Daccess, Daccess=object-type, Identifier=(identifier-list), Protection, and Rmu. If you specify more than one class, separate the classes with commas, and enclose the list of classes within parentheses. The following list provides a description of each option:

- All
Enables or disables all possible audit event classes.
- Daccess
Enables or disables DACCESS (discretionary access) audit events.
A DACCESS audit event occurs whenever a user issues a command that causes a check to be made for the existence of the appropriate privilege in an access privilege set (APS). To monitor access to a particular database object or group of objects, use the Daccess=object-type option to specify that a DACCESS audit record be produced whenever an attempt is made to access the object.

1.51 RMU Set Audit Command

Specifying the general Daccess option enables or disables the general DACCESS audit event type. If DACCESS event auditing is enabled and started for specific objects, auditing takes place immediately after you issue the RMU Set Audit command with the Enable=Daccess qualifier. Auditing starts for any users specified in the Identifier=(identifier-list) option who are attached to the database when the command is issued.

- Daccess=object-type[(object name)]/Privileges=(privilege-list)

Allows you to audit access to database objects by users in the Identifier=(identifier-list) option with the privileges you specify.

A DACCESS type event record indicates the command issued, the privilege used by the process issuing the command, and whether the attempt to access the object was successful.

The object-type option enables or disables DACCESS auditing for the specified object type. You can specify one or more object types in an RMU Set Audit command. The three valid object types are:

- DATABASE

When you specify the DATABASE object type, you must use the Privileges qualifier to specify one or more privileges to be audited for the database. Do not specify an object name with the DATABASE object type.

- TABLE

Specify the TABLE option for both tables and views. When you specify the TABLE object type, you must specify one or more table names with the object name parameter. You must also use the Privileges qualifier to specify one or more privileges to be audited for the specified tables.

- COLUMN

When you specify the COLUMN object type, you must specify one or more column names with the object name parameter. Specify the table name that contains the column by using the following syntax:

table-name.column-name

If you specify more than one column, separate the list of table-name.column-names with commas, and enclose the list within parentheses. You must also use the Privileges qualifier to specify one or more privileges to be audited for the specified columns.

The object name parameter enables or disables DACCESS auditing for the specified object or objects. If you specify more than one object name, separate the object names with commas, and enclose the list of object names within parentheses.

1.51 RMU Set Audit Command

If you specify one or more object names, you must select one or more privileges to audit. Use the Privileges=privilege-list qualifier to select the privileges that are to be audited for each of the objects in the object name list when the selected objects are accessed. The privileges that can be specified with the Privileges qualifier are listed in Table 1–13.

Privilege names SUCCESS and FAILURE can be used as a convenient way to specify that all successful or failed accesses to that object for all privileges should be audited. The privilege name All can be used with the Enable or Disable qualifier to turn on or turn off auditing for all privileges applicable to the object.

If you specify a privilege that does not apply to an object, Oracle Rdb allows it, but will not produce any auditing for that privilege. You can specify only SQL privileges with the Privileges=(privilege-list) qualifier. The privileges that can be specified for each Oracle Rdb object type are shown in Table 1–13. The Relational Database Operator (RDO) privileges that correspond to the SQL privileges are included in Table 1–13 to help RDO users select the appropriate SQL privileges for auditing.

Table 1–13 DACCESS Privileges for Database Objects

SQL Privilege	RDO Privilege	Database	Table/View	Column
ALTER	CHANGE	Y	Y	N
CREATE	DEFINE	Y	Y	N
DBADM	ADMINISTRATOR	Y	N	N
DBCTRL	CONTROL	Y	Y	N
DELETE	ERASE	N	Y	N
DISTRIBTRAN	DISTRIBTRAN	Y	N	N
DROP	DELETE	Y	Y	N
INSERT	WRITE	N	Y	N
REFERENCES	REFERENCES	N	Y	Y
SECURITY	SECURITY	Y	N	N
SELECT	READ	Y	Y	N
UPDATE	MODIFY	N	Y	Y

(continued on next page)

1.51 RMU Set Audit Command

Table 1–13 (Cont.) DACCESS Privileges for Database Objects

SQL Privilege	RDO Privilege	Database	Table/View	Column
SUCCESS	SUCCESS	Y	Y	Y
FAILURE	FAILURE	Y	Y	Y
ALL	ALL	Y	Y	Y

- Identifier=(identifier-list)

Enables or disables auditing of user access to objects listed in the Enable=Daccess=object-type qualifier. If you do not specify this option, no users are audited for the DACCESS event. Any user whose identifier you specify is audited for accessing the database objects with the privileges specified. You can specify wildcard characters within the identifiers to identify groups of users. The [*,*] identifier indicates public, and causes all users to be audited. If you specify a nonexistent identifier, you receive an error message.

The order of identifiers in the identifier list is not significant. A user is audited if he or she holds any of the identifiers specified in the identifier list.

You can specify user identification code (UIC) identifiers, general identifiers, and system-defined identifiers in the identifier list. For more information on identifiers, see the *Oracle Rdb Guide to Database Design and Definition*.

If you specify more than one identifier, separate the identifiers with commas, and enclose the identifier list within parentheses. UIC identifiers with commas such as [RDB,JONES] must be enclosed within quotation marks as follows:

```
IDENTIFIER=(INTERACTIVE, "[RDB,JONES]", SECRETARIES)
```

When you use Identifier=(identifier-list) to specify one or more identifiers to be audited, those identifiers are audited whenever they access any object for which auditing has been enabled.

- Protection

Allows you to audit changes made to access privilege sets for database objects by means of the SQL GRANT and REVOKE statements.

- Rmu

Audits the use of Oracle RMU commands by users with the privilege to use them.

1.51 RMU Set Audit Command

Every Noevery

Sets the granularity of DACCESS event auditing for the database. When you specify the Every qualifier, every access check for the specified objects using the specified privilege or privileges during a database attachment is audited. When you specify the Noevery qualifier, each user's first access check for the specified audit objects using the specified privilege or privileges during a database attachment is audited. The First qualifier is a synonym for the Noevery qualifier; the two qualifiers can be used interchangeably.

The default is the Every qualifier.

First

Specifies that when DACCESS event auditing is enabled, each user's first access check for the specified audit objects using the specified privilege or privileges during a database attachment is audited. The First qualifier is a synonym for the Noevery qualifier; the two qualifiers can be used interchangeably.

Flush Noflush

Indicates whether forced writes of audit journal records are currently enabled for the database. Forced writes will cause Oracle Rdb to write (flush) the audit journal record immediately out to disk when the audit record is produced, rather than waiting for the audit server to flush the audit records at specified intervals of seconds.

The default is the Noflush qualifier, which flushes audit records every interval of seconds. To specify the interval, use the DCL command SET AUDIT /INTERVAL=JOURNAL_FLUSH=time.

Start

Starts Oracle Rdb security auditing for the database. The Start qualifier by itself starts both security alarms and security audit journal records. Also, you can supply the Type=Alarm qualifier or the Type=Audit qualifier to start security alarms only or security audit journaling only.

When you specify the Start qualifier, auditing starts immediately for all audit event classes that are currently enabled. Any subsequent audit events of currently attached users are recorded in the security audit journal, or alarms are sent to security-enabled terminals, or both, depending on what you have specified for your database.

1.51 RMU Set Audit Command

Stop

Stops Oracle Rdb security auditing for the database. The Stop qualifier by itself stops both security alarms and security audit journal records. Also, you can supply the Type=Alarm qualifier or the Type=Audit qualifier to stop security alarms only or security audit journaling only.

When you specify the Stop qualifier, the alarms or audits (or both) of all audit event classes are immediately stopped (depending on whether you specified the Type=Alarm qualifier, the Type=Audit qualifier, or neither). The audit event classes previously specified with the Enable qualifier remain enabled, and you can start them again by using the Start qualifier.

Type=option

Specifies that security alarms or security audit journal records (or both) be enabled or disabled. The following options are available with the Type qualifier:

- Alarm
Causes subsequent qualifiers in the command line (Start, Stop, Enable, and Disable) to generate or affect security alarm messages that are sent to all terminals enabled as security operator terminals.
- Audit
Causes subsequent qualifiers in the command line (Start, Stop, Enable, and Disable) to generate or affect security audit journal records that are recorded in the security audit journal file.

If you do not specify the Type qualifier with the RMU Set Audit command, Oracle RMU enables or disables both security alarms and security audit journal records.

Usage Notes

- To use the RMU Set Audit command for a database, you must have the RMU\$SECURITY privilege in the root file ACL for the database or the OpenVMS SECURITY or BYPASS privilege.
- Audit journal records collected on a database can be stored only in the database from which they were collected. The database name specified with the RMU Load command with the Audit qualifier identifies to Oracle Rdb both the audit records to be loaded and the database into which they are to be loaded.

1.51 RMU Set Audit Command

- There is very little overhead associated with security auditing; no extra disk I/O is involved. Therefore, you need not be concerned about the impact to database performance should you decide to enable security auditing.
- You can use the `Daccess=object-type` option to enable `DACCESS` checking for specific objects, but the general `DACCESS` class is not enabled until you explicitly enable it by using the `Enable=Daccess` qualifier with the `RMU Set Audit` command. Also, you need to use the `Start` qualifier with the `RMU Set Audit` command to start the auditing and alarms that have been enabled.
- Alarms are useful for real-time tracking of auditing information. At the moment an alarm occurs, text messages regarding the alarm are displayed on security-enabled terminals.

To enable a terminal to receive Oracle Rdb security alarms, enter the `DCL REPLY/ENABLE=SECURITY` command. You must have both the OpenVMS `SECURITY` and OpenVMS `OPER` privileges to use the `REPLY/ENABLE=SECURITY` command.

- Audit records are useful for periodic reviews of security events. Audit records are stored in a security audit journal file, and can be reviewed after they have been loaded into a database table with the `RMU Load` command with the `Audit` qualifier. Use the `DCL SHOW AUDIT/JOURNAL` command to determine the security audit journal file being used by your database.
- The `AUDIT` class is always enabled for both alarms and audit records, but does produce any alarms or audit records until auditing is started. The `AUDIT` class cannot be disabled.
- When you specify the `Daccess=object-type` option and one or more other options in an options list, the `Privileges=(privilege-list)` qualifier must begin after the closing parenthesis for the options list.
- To display the results of an `RMU Set Audit` command, enter the `RMU Show Audit` command.
- You can use the `Disable` and `Enable` qualifiers with indirect file references. See Section 1.3 for more information.
- When the `RMU Set Audit` command is issued for a closed database, the command executes without other users being able to attach to the database.

1.51 RMU Set Audit Command

Examples

Example 1

In the following example, the first command enables alarms for the RMU and PROTECTION classes. The second command shows that alarms for the RMU and PROTECTION classes are enabled but not yet started. The AUDIT class is always enabled and cannot be disabled. The third command starts alarms for the RMU and PROTECTION classes. The fourth command shows that alarms for the RMU and PROTECTION classes are enabled and started.

```
$ ! Enable alarms for RMU and PROTECTION classes:
$ RMU/SET AUDIT/TYPE=ALARM/ENABLE=(RMU,PROTECTION) MF_PERSONNEL
$ !
$ ! Show that alarms are enabled, but not yet started:
$ RMU/SHOW AUDIT/ALL MF_PERSONNEL
Security auditing STOPPED for:
    PROTECTION (disabled)
    RMU (disabled)
    AUDIT (enabled)
    DACCESS (disabled)

Security alarms STOPPED for:
    PROTECTION (enabled)
    RMU (enabled)
    AUDIT (enabled)
    DACCESS (disabled)

Audit flush is disabled

Audit every access

Enabled identifiers:
    None

$ ! Start alarms for the enabled RMU and PROTECTION classes:
$ RMU/SET AUDIT/START/TYPE=ALARM MF_PERSONNEL
$ !
$ ! Show that alarms are started for the RMU and PROTECTION classes:
$ RMU/SHOW AUDIT/ALL MF_PERSONNEL
Security auditing STOPPED for:
    PROTECTION (disabled)
    RMU (disabled)
    AUDIT (enabled)
    DACCESS (disabled)

Security alarms STARTED for:
    PROTECTION (enabled)
    RMU (enabled)
    AUDIT (enabled)
    DACCESS (disabled)

Audit flush is disabled

Audit every access

Enabled identifiers:
    None
```

1.51 RMU Set Audit Command

Example 2

In this example, the first command shows that alarms are started and enabled for the RMU class. The second command disables alarms for the RMU class. The third command shows that alarms for RMU class are disabled.

```
$ ! Show that alarms are enabled and started for the RMU class:
$ RMU/SHOW AUDIT/ALL MF_PERSONNEL
Security auditing STOPPED for:
  PROTECTION (disabled)
  RMU (disabled)
  AUDIT (enabled)
  DACCESS (disabled)

Security alarms STARTED for:
  PROTECTION (disabled)
  RMU (enabled)
  AUDIT (enabled)
  DACCESS (disabled)

Audit flush is disabled

Audit every access

Enabled identifiers:
  None

$ ! Disable alarms for the RMU class:
$ RMU/SET AUDIT/TYPE=ALARM/DISABLE=RMU MF_PERSONNEL
$ !
$ ! Show that alarms are disabled for the RMU class:
$ RMU/SHOW AUDIT/ALL MF_PERSONNEL
Security auditing STOPPED for:
  PROTECTION (disabled)
  RMU (disabled)
  AUDIT (enabled)
  DACCESS (disabled)

Security alarms STARTED for:
  PROTECTION (disabled)
  RMU (disabled)
  AUDIT (enabled)
  DACCESS (disabled)

Audit flush is disabled

Audit every access

Enabled identifiers:
  None
```

Example 3

In this example, the first command enables auditing for users with the [SQL,USER1] and [RDB,USER2] identifiers. The second command shows the enabled identifiers. The third command enables DACCESS checks requiring SELECT and INSERT privileges for the EMPLOYEES and COLLEGES tables. The fourth command displays the DACCESS checks that have been specified

1.51 RMU Set Audit Command

for the COLLEGES and EMPLOYEES tables. Note that because the general DACCESS type has not been enabled, DACCESS for the EMPLOYEES and COLLEGES tables is displayed as disabled.

```
$ ! Enable auditing for users with the [SQL,USER1] and
$ ! [RDB,USER2] identifiers:
$ RMU/SET AUDIT/ENABLE=IDENTIFIER=("[SQL,USER1]", "[RDB,USER2]") -
_$ MF_PERSONNEL
$ !
$ ! Show that [SQL,USER1] and [RDB,USER2] are enabled identifiers:
$ RMU/SHOW AUDIT/ALL MF_PERSONNEL
Security auditing STOPPED for:
    PROTECTION (disabled)
    RMU (disabled)
    AUDIT (enabled)
    DACCESS (disabled)

Security alarms STOPPED for:
    PROTECTION (disabled)
    RMU (disabled)
    AUDIT (enabled)
    DACCESS (disabled)

Audit flush is disabled

Audit every access

Enabled identifiers:
    (IDENTIFIER=[SQL,USER1])
    (IDENTIFIER=[RDB,USER2])

$ ! Enable and start DACCESS checks for the SELECT and INSERT
$ ! privileges for the COLLEGES and EMPLOYEES tables:
$ RMU/SET AUDIT/ENABLE=DACCESS=TABLE=(COLLEGES,EMPLOYEES) -
_$ /PRIVILEGES=(SELECT,INSERT)/START MF_PERSONNEL
$ !
$ ! Display the DACCESS checks that are enabled and
$ ! started for the COLLEGES and EMPLOYEES tables:
$ RMU/SHOW AUDIT/DACCESS=TABLE MF_PERSONNEL
Security auditing STARTED for:
    DACCESS (disabled)
        TABLE : EMPLOYEES
            (SELECT,INSERT)
        TABLE : COLLEGES
            (SELECT,INSERT)

Security alarms STARTED for:
    DACCESS (disabled)
        TABLE : EMPLOYEES
            (SELECT,INSERT)
        TABLE : COLLEGES
            (SELECT,INSERT)
```

1.51 RMU Set Audit Command

Example 4

In this example, the first command enables auditing of the JOBS and EMPLOYEES tables for DACCESS checks for users with the [SQL,USER1] or BATCH identifier. The Privileges=All qualifier specifies that auditing will be produced for every privilege. The second command shows that auditing is enabled for users with the [SQL,USER1] or BATCH identifier. The third command shows that DACCESS checking for the JOBS and EMPLOYEES tables for all privileges is specified. The fourth command enables the general DACCESS class. The fifth command's output shows that the general DACCESS class is now enabled. The sixth command starts the auditing that is enabled, and the seventh command shows that the enabled auditing is started.

```
$ ! Enable DACCESS checks for users with the [SQL,USER1] or
$ ! BATCH identifier for the JOBS and EMPLOYEES tables:
$ RMU/SET AUDIT/TYPE=AUDIT -
_ $ /ENABLE=(IDENTIFIER=("[SQL,USER1]",BATCH), -
_ $ DACCESS=TABLE=(JOBS,EMPLOYEES)) /PRIVILEGES=ALL MF_PERSONNEL
$ !
$ ! Show that auditing is enabled for users with the [SQL,USER1]
$ ! or BATCH identifiers:
$ RMU/SHOW AUDIT/ALL MF_PERSONNEL
Security auditing STOPPED for:
  PROTECTION (disabled)
  RMU (disabled)
  AUDIT (enabled)
  DACCESS (disabled)

Security alarms STOPPED for:
  PROTECTION (disabled)
  RMU (disabled)
  AUDIT (enabled)
  DACCESS (disabled)

Audit flush is disabled

Audit every access

Enabled identifiers:
  (IDENTIFIER=[SQL,USER1])
  (IDENTIFIER=BATCH)

$ ! Show that DACCESS checking for all privileges for the
$ ! JOBS and EMPLOYEES tables is enabled:
$ RMU/SHOW AUDIT/DACCESS=TABLE MF_PERSONNEL
Security auditing STOPPED for:
  DACCESS (disabled)
    TABLE : EMPLOYEES
      (ALL)
    TABLE : JOBS
      (ALL)

Security alarms STOPPED for:
  DACCESS (disabled)
```

1.51 RMU Set Audit Command

```
$ ! Enable the general DACCESS class:
$ RMU/SET AUDIT/ENABLE=DACCESS MF_PERSONNEL
$ !
$ ! Show that the general DACCESS class is enabled:
$ RMU/SHOW AUDIT/DACCESS=TABLE MF_PERSONNEL
Security auditing STOPPED for:
  DACCESS (enabled)
    TABLE : EMPLOYEES
      (ALL)
    TABLE : JOBS
      (ALL)

Security alarms STOPPED for:
  DACCESS (enabled)

$ ! Start the auditing that is enabled:
$ RMU/SET AUDIT/START MF_PERSONNEL
$ !
$ ! Show that the enabled auditing is started:
$ RMU/SHOW AUDIT/ALL MF_PERSONNEL
Security auditing STARTED for:
  PROTECTION (disabled)
  RMU (disabled)
  AUDIT (enabled)
  DACCESS (enabled)

Security alarms STARTED for:
  PROTECTION (disabled)
  RMU (disabled)
  AUDIT (enabled)
  DACCESS (enabled)

Audit flush is disabled

Audit every access

Enabled identifiers:
  (IDENTIFIER=[SQL,USER1])
  (IDENTIFIER=BATCH)
```

Example 5

In this example, the first command enables DACCESS checks requiring the INSERT privilege for the mf_personnel database, for the EMPLOYEES table, and for the EMPLOYEE_ID column of the EMPLOYEES table. The second command shows that the DACCESS check for the INSERT privilege is enabled for the specified objects.

```
$ ! Enable a DACCESS check for the INSERT privilege for the
$ ! MF_PERSONNEL database, EMPLOYEES table, and EMPLOYEE_ID
$ ! column of the EMPLOYEES table:
$ RMU/SET AUDIT -
_$/ENABLE=DACCESS=(DATABASE, TABLE=EMPLOYEES, -
_$/COLUMN=EMPLOYEES.EMPLOYEE_ID) -
_$/PRIVILEGES=(INSERT) MF_PERSONNEL
```

1.51 RMU Set Audit Command

```
$ !
$ ! Show that the DACCESS check for the INSERT privilege is
$ ! enabled for the specified objects. (The general DACCESS
$ ! class remains disabled until you issue an
$ ! RMU/SET AUDIT/ENABLE=Daccess command without specifying
$ ! any object-type parameter to the Daccess option.
$ ! See the fourth Oracle RMU command in Example 4.)
$ !
$ RMU/SHOW AUDIT/DACCESS=(DATABASE, TABLE, COLUMN) MF_PERSONNEL
Security auditing STOPPED for:
  DACCESS (disabled)
    DATABASE
      (INSERT)
    TABLE : EMPLOYEES
      (INSERT)
    COLUMN : EMPLOYEES.EMPLOYEE_ID
      (INSERT)

Security alarms STOPPED for:
  DACCESS (disabled)
    DATABASE
      (INSERT)
    TABLE : EMPLOYEES
      (INSERT)
    COLUMN : EMPLOYEES.EMPLOYEE_ID
      (INSERT)
```

Example 6

In this example, the first command enables a DACCESS check requiring the INSERT privilege for the EMPLOYEES and COLLEGES tables, as well as for the EMPLOYEE_ID and LAST_NAME columns of the EMPLOYEES table and the COLLEGE_CODE column of the COLLEGES table in the mf_personnel database. The second command shows that the DACCESS check for the INSERT privilege is enabled for the specified objects.

```
$ ! Enable a DACCESS check for the INSERT privilege for the
$ ! EMPLOYEES and COLLEGES table, the LAST_NAME and EMPLOYEE_ID
$ ! column of the EMPLOYEES table, and the COLLEGE_CODE column
$ ! of the COLLEGES table:
$ RMU/SET AUDIT -
_$/ENABLE=DACCESS=(TABLE=(EMPLOYEES, COLLEGES), -
_$/COLUMN=(EMPLOYEES.EMPLOYEE_ID, -
_$/EMPLOYEES.LAST_NAME, -
_$/COLLEGES.COLLEGE_CODE)) -
_$/PRIVILEGES=(INSERT) MF_PERSONNEL
$ !
$ ! Show that the DACCESS check for the INSERT privilege is
$ ! enabled for the specified objects. (The general DACCESS
$ ! class remains disabled until you issue an
$ ! RMU/SET AUDIT/ENABLE=Daccess command without specifying
$ ! any object-type parameter to the Daccess option.
$ ! See the fourth Oracle RMU command in Example 4.)
$ !
```

1.51 RMU Set Audit Command

```
$ RMU/SHOW AUDIT/DACCESS=(DATABASE, TABLE, COLUMN) MF_PERSONNEL
Security auditing STOPPED for:
  DACCESS (disabled)
    DATABASE
      (NONE)
    TABLE : COLLEGES
      (INSERT)
    TABLE : EMPLOYEES
      (INSERT)
    COLUMN : COLLEGES.COLLEGE_CODE
      (INSERT)
    COLUMN : EMPLOYEES.EMPLOYEE_ID
      (INSERT)
    COLUMN : EMPLOYEES.LAST_NAME
      (INSERT)

Security alarms STOPPED for:
  DACCESS (disabled)
    DATABASE
      (NONE)
    TABLE : COLLEGES
      (INSERT)
    TABLE : EMPLOYEES
      (INSERT)
    COLUMN : COLLEGES.COLLEGE_CODE
      (INSERT)
    COLUMN : EMPLOYEES.EMPLOYEE_ID
      (INSERT)
    COLUMN : EMPLOYEES.LAST_NAME
      (INSERT)
```

1.52 RMU Set Buffer_Object Command

1.52 RMU Set Buffer_Object Command

On a database basis, controls which database objects use the OpenVMS Fast I/O and Buffer Objects features.

Format

RMU/Set Buffer_Object root-file-spec

<u>Command Qualifiers</u>	<u>Defaults</u>
/Disable=enable-disable-options	See description
/Enable=enable-disable-options	See description
/[No]Log	Current DCL verify value

Description

Use the RMU Set Buffer_Object command to control, on a database basis, which database objects use the OpenVMS Fast I/O and Buffer Objects features.

Command Parameters

root-file-spec

The root file specification of the database. The default file extension is .rdb.

Command Qualifiers

Disable=enable-disable-options

Disables buffer objects for the specified Oracle Rdb buffers. You can specify one or more of the following buffer objects: Page, AIJ, RUJ, and Root. Refer to Table 1–14 for more information about these keywords. If you specify more than one object, separate the objects with commas, and enclose the list of objects within parentheses.

Enable=enable-disable-options

Enables buffer objects for the specified Oracle Rdb buffers. You can specify one or more of the following buffer objects: Page, AIJ, RUJ, and Root. Refer to Table 1–14 for more information about these keywords. If you specify more than one object, separate the objects with commas, and enclose the list of objects within parentheses.

1.52 RMU Set Buffer_Object Command

If you specify the Enable and Disable qualifiers for the same buffer object, the Enable option prevails and the buffer object state is enabled for the specified object type.

Table 1–14 Buffer Object Control

Object	Keyword	Logical Name
Data pages	PAGE	RDM\$BIND_PAGE_BUFOBJ_ENABLED
AIJ output	AIJ	RDM\$BIND_AIJ_BUFOBJ_ENABLED
RUJ	RUJ	RDM\$BIND_RUJ_BUFOBJ_ENABLED
Root file	ROOT	RDM\$BIND_ROOT_BUFOBJ_ENABLED

Note

If a logical is defined as "1" then the corresponding buffer will be created as an OpenVMS buffer object.

Log

Nolog

Specifies whether the processing of the command is reported to SYS\$OUTPUT. Specify the Log qualifier to request log output and the Nolog qualifier to prevent it. If you specify neither, the default is the current setting of the DCL verify switch.

Usage Notes

- The Enable and Disable qualifiers are mutually exclusive.
- The RMU Set Buffer_Object command requires exclusive database access; that is, the database cannot be open or be accessed by other users.
- Buffer objects are memory resident and thus reduce the amount of physical memory available to OpenVMS for other uses. Buffer object use requires that the user be granted the VMS\$BUFFER_OBJECT_USER rights identifier. The system parameter MAXBOBMEM needs to be large enough to allow all buffer objects for all users to be created. For further information regarding Fast I/O, consult the OpenVMS documentation.

1.52 RMU Set Buffer_Object Command

Example

The following example demonstrates enabling ROOT buffer objects and disabling PAGE buffer objects. The RMU /DUMP /HEADER command is used to validate the change.

```
$RMU /SET BUFFER_OBJECT /ENABLE=(ROOT) /DISABLE=(PAGE) MF_PERSONNEL
%RMU-I-MODIFIED, Buffer objects state modified
%RMU-W-DOFULLBCK, full database backup should be done to ensure futur
$ RMU/DUMP/HEAD MF_PERSONNEL
.
.
.
- OpenVMS Alpha Buffer Objects are enabled for
  Root I/O Buffers
```

1.53 RMU Set Corrupt_Pages Command

1.53 RMU Set Corrupt_Pages Command

Allows you to set pages, storage areas, and snapshot files as either corrupt or consistent in the corrupt page table (CPT). A corrupt page is one that contains meaningless data; an inconsistent page is one that contains old data (data that is not at the same transaction level as the database root file). Corrupt pages are logged to the CPT, which is maintained in the database root file. When the CPT becomes full (due to a large number of pages being logged), the area containing the most corrupt pages is marked as corrupt and the individual corrupt pages for that area are removed from the corrupt page table. The Oracle RMU Set Corrupt_Pages operation is an offline operation.

If you reset a page or storage area in the CPT to consistent it does not remove any true corruption or inconsistencies. However, if you reset a snapshot file in the CPT to consistent, Oracle RMU initializes the snapshot file and thus removes any true corruption or inconsistency.

Caution

Use the RMU Set Corrupt_Pages command only after you fully understand the internal data structure and know the information the database should contain. Setting a page in a storage area that is truly corrupt or inconsistent to consistent does not remove the corruption or inconsistency. Setting truly corrupt or inconsistent pages in a storage area to consistent and continuing to access those pages can result in unrecoverable corruptions to the database.

The RMU Restore and RMU Recover commands should be used first and should be part of your normal operating procedure.

Note

This command replaces two RdbALTER statements: MAKE CONSISTENT and UNCORRUPT. Both the RdbAlter statements, MAKE CONSISTENT and UNCORRUPT, are deprecated commands that may be removed in future versions.

1.53 RMU Set Corrupt_Pages Command

When a storage area is restored from backup files on a by-area basis, it does not reflect data that has been updated since the backup operation. The transaction level of the restored area reflects the transaction level of the backup file, not the transaction level of the database. Therefore, the transaction level of the restored area differs from that of the database. Oracle Rdb marks the area by setting a flag in the storage area file to inconsistent.

You can perform a recovery by area to upgrade the transaction level of the restored area to that of the database. (After-image journaling must be enabled in order to restore by area.) If you are certain that no updates have been made to the database since the backup operation, you can use the RMU Set Corrupt_Pages command to change the setting of the flag from inconsistent to consistent.

In addition, storage areas are corrupted by attempting an SQL rollback with one or more storage areas opened in batch-update transaction mode.

The RMU Set Corrupt_Pages command allows you to access a database that is in an uncertain condition. Accordingly, the following message and question are displayed when you enter it to correct a corrupt or inconsistent storage area or storage area page. (This message is not displayed if you enter it to correct a corrupt or inconsistent snapshot file.)

```
***** WARNING! *****
```

```
Marking a storage area or page consistent does not
remove the inconsistencies. Remove any inconsistencies
or corruptions before you proceed with this action.
```

```
Do you wish to continue? [N]
```

Format

RMU/Set Corrupt_Pages root-file-spec

<u>Command Qualifiers</u>	<u>Defaults</u>
/Area=identity	None
/Consistent	None
/Corrupt	None
/Disk=device	None
/Page=(n,...)	None

1.53 RMU Set Corrupt_Pages Command

Description

The RMU Set Corrupt_Pages command allows you to override the required RMU Recover command after a by-area restore operation. Although Oracle RMU cannot determine when the recover operation is superfluous, you might have that knowledge. If you are certain of this knowledge, you can abridge the requirement for the recover operation by using the RMU Set Corrupt_Pages command to set corrupt pages to consistent.

Similarly, sometimes you might know of a problem that Oracle RMU does not recognize. For example, you might find that a page contains an index node that causes a bugcheck dump each time it is accessed. You can use the RMU Set Corrupt_Pages command to mark this page as corrupt and then follow your usual procedure for recovering from database corruption.

Note that the RMU Set Corrupt_Pages command with the Consistent qualifier does not make truly corrupt storage area pages usable. Corrupt storage area pages detected during normal operation are logged in the CPT, and likely have an invalid checksum value. The RMU Set Corrupt_Pages command with the Consistent qualifier removes the specified pages from the CPT, but the next time a user tries to touch that storage area page, it is logged in the CPT again because it is still physically corrupt. To correct a storage area page that is truly corrupt, you must restore it from a backup file.

The RMU Set Corrupt_Pages command with the Consistent qualifier does make truly corrupt or inconsistent pages in a snapshot file usable. When you use this command and specify a snapshot file with the areas qualifier, Oracle RMU initializes the specified snapshot file.

Command Parameters

root-file-spec

The file specification of the database root file for which you want to set pages or areas to corrupt or consistent.

Command Qualifiers

Area=identity

Specifies a particular storage area file or snapshot file. The identity for a storage area can be either the area name (for example, EMPIDS_OVER), or a storage area ID number (for example, 5). The identity for a snapshot file must be the snapshot file ID number. Use the RMU Dump command with the Header qualifier to display the ID numbers associated with a storage area file or a snapshot file.

1.53 RMU Set Corrupt_Pages Command

When you use the Area qualifier with the Page=(n,...) qualifier, the command specifies the named pages in the named storage area or snapshot file. When you specify the Area qualifier without the Page qualifier, the command specifies all pages of the specified storage area or snapshot file.

The Area qualifier cannot be used with the Disk qualifier.

Consistent

Specifies that the pages, areas, or snapshot files specified with the Page, Area, or Disk qualifier are to be considered consistent with the remainder of the database.

If you make a storage area or page in a storage area consistent while it is marked in the database as not corrupt, but inconsistent, you receive a warning and are required to confirm your request to carry out this operation before the operation will complete.

You cannot use the Consistent qualifier with the Corrupt qualifier.

Corrupt

Specifies that the pages, areas, or snapshot files specified with the Page, Area, or Disk qualifier are to be considered corrupt.

You cannot use the Corrupt qualifier with the Consistent qualifier.

Disk=device

Specifies all the pages, all the storage areas, and all the snapshot files on the named device be set as you indicate with the Corrupt or the Consistent qualifier.

You cannot use the Disk qualifier with the Page or the Area qualifier.

Page=(n,...)

Specifies the listed page numbers.

You must specify the Area qualifier when you use the Page qualifier.

You cannot use the Page qualifier with the Disk qualifier.

Usage Notes

- You must have the RMU\$ALTER, RMU\$BACKUP, or RMU\$RESTORE privilege in the root file access control list (ACL) for a database or the OpenVMS SYSPRV or BYPASS privilege to use the RMU Set Corrupt_Pages command for the database.

1.53 RMU Set Corrupt_Pages Command

- You can issue the RMU Set Corrupt_Pages command while users are attached to the database.
- You must specify either the Corrupt or the Consistent qualifier (but not both) when you use the RMU Set Corrupt_Pages command.
- When you use the RMU Set Corrupt_Pages command to mark a page as corrupt or consistent, the database is marked as having been altered.

Examples

Example 1

The following command sets storage area EMPIDS_MID in the mf_personnel database as corrupt:

```
$ RMU/SET CORRUPT_PAGES/AREA=EMPIDS_MID/CORRUPT MF_PERSONNEL
%RMU-I-AREAMARKED, Area 4 was marked corrupt.
```

Example 2

The following command marks EMPIDS_MID as consistent. This is the area that was marked as corrupt in Example 1. However, in this case, instead of using the storage area name in the Oracle RMU command, the storage area identifier is used.

```
$ RMU/SET CORRUPT_PAGES/AREA=4/CONSISTENT MF_PERSONNEL
```

```
***** WARNING! *****
```

```
Marking a storage area or page consistent does not
remove the inconsistencies. Remove any inconsistencies
or corruptions before you proceed with this action.
```

```
Do you wish to continue? [N] Y
```

```
%RMU-I-AREAMARKED, Area 4 was marked consistent .
```

Example 3

The following command marks page 1 in area 3 in the mf_personnel database as corrupt. Using the RMU Show Corrupt_Pages command confirms that the page has been marked as expected.

```
$ RMU/SET CORRUPT_PAGES/AREA=3/PAGE=1/CORRUPT MF_PERSONNEL
%RMU-I-PAGEMARKED, Page 1 in area 3 was marked corrupt.
```

1.53 RMU Set Corrupt_Pages Command

```
$ RMU/SHOW CORRUPT_PAGES MF_PERSONNEL.RDB
*-----*
* Oracle Rdb V7.0-00                               3-JUL-1996 17:01:20.62
*
* Dump of Corrupt Page Table
* Database: USER1:[DB]MF_PERSONNEL.RDB;1
*
*-----*

Entries for storage area EMPIDS_LOW
-----

Page 1
- AIJ recovery sequence number is -1
- Live area ID number is 3
- Consistency transaction sequence number is 0:0
- State of page is: corrupt

*-----*
* Oracle Rdb V7.0-00                               3-JUL-1996 17:01:20.82
*
* Dump of Storage Area State Information
* Database: USER1:[DB]MF_PERSONNEL.RDB;1
*
*-----*

All storage areas are consistent.
```

Example 4

The following example sets page 4 of the snapshot file for EMPIDS_OVER to consistent. Because Oracle RMU initializes snapshot files specified with the Set Corrupt_Pages command, the snapshot file is removed from the corrupt page table and is now usable.

```
$ RMU/SET CORRUPT_PAGES MF_PERSONNEL.RDB/AREA=14/PAGE=3/CONSISTENT
%RMU-I-PAGEMARKED, Page 3 in area 14 was marked consistent.
```

1.54 RMU Set Galaxy Command

Allows you to enable or disable the database utilization of an OpenVMS Galaxy configuration without requiring that the database be open.

Format

RMU/Set Galaxy root-file-spec

<u>Command Qualifiers</u>	<u>Defaults</u>
/Disable	See description
/Enable	See description
/[No]Log	Current DCL verify value

Description

Use this command to enable or disable Galaxy features on an Oracle Rdb database. Databases opened on multiple copies of the OpenVMS operating system within a Galaxy system can share, in memory, database structures including global buffers, row caches, and root file objects.

Command Parameters

root-file-spec

The root file specification of the database. The default file extension is .rdb.

Command Qualifiers

Disable

Specifies that Galaxy features are to be disabled for the database.

Enable

Specifies that Galaxy features are to be enabled for the database.

Log

Nolog

Displays a log message at the completion of the RMU Set Galaxy operation.

1.54 RMU Set Galaxy Command

Usage Notes

- The Enable and Disable qualifiers are mutually exclusive.
- The RMU Set Galaxy command requires exclusive database access; that is, the database cannot be open or be accessed by other users.

Example

The following example enables the Galaxy features for the specified database.

```
$ RMU /SET GALAXY /ENABLE root-file-spec
```

1.55 RMU Set Global_Buffers Command

1.55 RMU Set Global_Buffers Command

Allows you to control the database global buffers feature without requiring that the database be open.

Format

RMU/Set Global_Buffers root-file-spec

<u>Command Qualifiers</u>	<u>Defaults</u>
/Disabled	None
/Enabled	None
/Large_Memory={Enabled Disabled}	None
/Log	None
/Number=n	None
/User_Limit=n	None

Description

If you move a database from one system to another, or when memory usage or system parameters change, you may have to modify the global buffer parameters for a database when it is not possible to open the database. This situation could occur, for example, if you have insufficient available physical or virtual memory.

The RMU Set Global_Buffers command allows you to alter some of the global buffer-related parameters without opening the database. This allows you to reconfigure the database so that it can be opened and accessed on the system.

Command Parameters

root-file-spec

Specifies the database root file for which you want to modify the global buffers feature.

Command Qualifiers

Disabled

Disables global buffers for the specified database.

Enabled

Enables global buffers for the specified database.

1.55 RMU Set Global_Buffers Command

Large_Memory={Enabled | Disabled}

Large_Memory=Enabled enables global buffers in large memory (VLM).

Large_Memory=Disabled disables global buffers in large memory (VLM).

Log

Displays a log message at the completion of the RMU Set Global_Buffers command.

Number=n

Sets the number of global buffers.

User_Limit=n

Sets the global buffers user limit value.

Usage Notes

- This command requires exclusive database access (the database cannot be open or accessed by other users).
- The Enabled and Disabled qualifiers are mutually exclusive.
- The Large_Memory=Enabled and Large_Memory=Disabled qualifiers are mutually exclusive.
- Changes made by the RMU Set Global_Buffers command are not journaled. You should make a subsequent full database backup to ensure recovery.
- When global buffers are set to reside in large memory (Large_Memory=Enabled), the process that opens the database must be granted the VMS\$MEM_RESIDENT_USER rights identifier. Oracle Corporation recommends that you use the RMU Open command when you utilize this feature.

1.56 RMU Set Logminer Command

Allows you to change the LogMiner state of a database.

Format

RMU/Set Logminer root-file-spec

Command Qualifiers

/Continuous
/Disable
/Enable
/[No]Log

Defaults

/NoContinuous
See description
See description
Current DCL verify value

Description

Use this command to enable or disable LogMiner operations on an Oracle Rdb database. When LogMiner is enabled, the Oracle Rdb database software writes additional information to the after-image journal file when records are added, modified, and deleted from the database. This information is used during the unload operation.

Command Parameters

root-file-spec

The root file specification of the database. The default file extension is .rdb.

Command Qualifiers

Continuous

NoContinuous

Enables the database for the Continuous LogMiner feature when used in conjunction with the Enable qualifier. Use the NoContinuous qualifier with the Enable qualifier to disable use of the Continuous LogMiner feature.

The RMU Set Logminer /Disable command explicitly disables the Continuous LogMiner feature as well as the base LogMiner functionality. To enable the Continuous LogMiner feature again, the entire RMU Set Logminer /Enable /Continuous command must be used.

1.56 RMU Set Logminer Command

Disable

Specifies that LogMiner operations are to be disabled for the database. When LogMiner is disabled, the Oracle Rdb software does not journal information required for LogMiner operations. When LogMiner is disabled for a database, the RMU Unload After_Journal command is not functional on that database.

Enable

Specifies that LogMiner operations are to be enabled for the database. When LogMiner is enabled, the Oracle Rdb database software logs additional information to the after-image journal file. This information allows LogMiner to extract records. The database must already have after-image journaling enabled.

Log

Nolog

Specifies that the setting of the LogMiner state for the database be reported to SYS\$OUTPUT. The default is the setting of the DCL VERIFY flag, which is controlled by the DCL SET VERIFY command.

Usage Notes

- To use the RMU Set Logminer command, you must have the RMU\$BACKUP, RMU\$RESTORE, or RMU\$ALTER privilege in the root file access control list (ACL) for the database or the OpenVMS SYSPRV or BYPASS privilege.
- The RMU Set Logminer command requires offline access to the database. The database must be closed and no other users may be accessing the database.
- Execute a full database backup operation after issuing an RMU Set Logminer command that displays the RMU-W-DOFULLBCK warning message. Immediately after enabling LogMiner, you should perform a database after-image journal backup using the RMU Backup After_Journal command.

Examples

Example 1

The following example enables a database for LogMiner for Rdb operation.

```
$ RMU /SET LOGMINER /ENABLE OLTPDB.RDB
```

1.57 RMU Set Privilege Command

1.57 RMU Set Privilege Command

Allows you to modify the root file access control list (ACL) for a database.

A database's root file ACL determines the Oracle RMU commands that users can execute for the associated database.

Format

RMU/Set Privilege root-file-spec

Command Qualifiers

/Acl[=(ace[,...])]
/Acl_File=filename
/After=ace
/Delete[=All]
/Edit
/[No]Journal[=file-spec]
/Keep[=(Recovery_Journal)]
/Like=source-root-file-spec
/[No]Log
/Mode=[No]Prompt
/New
/[No]Recover[=file-spec]
/Replace=(ace[,...])

Defaults

See description
See description
See description
See description
No editor invoked
/Journal
See description
None
/Nolog
/Mode=Prompt
None
/Norecover
None

Description

The RMU Set Privilege command allows you to manipulate an entire root file ACL, or to create, modify, or delete access control entries (ACEs) in a root file ACL. See the *Oracle Rdb Guide to Database Design and Definition* for introductory information on ACEs and ACLs.

Use the RMU Set Privilege command to add ACEs to a root file ACL by specifying the ACEs with the Acl qualifier.

Table 1–1 shows the privileges a user must have to access each Oracle RMU command.

If the database root file you specify with RMU Set Privilege command does not have an ACL, Oracle RMU creates one.

1.57 RMU Set Privilege Command

The RMU Set Privilege command provides the following qualifiers to manipulate ACEs and ACLs in various ways:

- After
- Delete
- Like
- New
- Replace

By default, any ACEs you add to a root file ACL are placed at the top of the ACL. Whenever Oracle RMU receives a request for Oracle RMU access for a database that has a root file ACL, it searches each entry in the ACL from the first to the last for the first match it can find, and then stops searching. If another match occurs further down in the root file ACL, it has no effect. Because the position of an ACE in a root file ACL is so important, you can use the After qualifier to correctly position an ACE. When you use the After qualifier, any additional ACEs are added after the specified ACE.

You can delete ACEs from an ACL by including the Delete qualifier and specifying the ACEs with the Acl qualifier. To delete all the ACEs, include the Delete qualifier and specify the Acl qualifier without specifying any ACEs.

You can copy an ACL from one root file to another by using the Like qualifier. The ACL of the root file specified with the Like qualifier replaces the ACL of the root file specified with the root-file-spec parameter.

Use the New qualifier to delete all ACEs before adding any ACEs specified by the Acl, Like, or Replace qualifiers.

You can replace existing ACEs in a root file ACL by using the Replace qualifier. Any ACEs specified with the Acl qualifier are deleted and replaced by those specified with the Replace qualifier.

The existing ACE can be abbreviated when you use the Delete, Replace, or After qualifiers.

Use the RMU Set Privilege command with the Edit qualifier to invoke the ACL editor. You can specify the following qualifiers only when you specify the Edit qualifier also:

- Journal
- Keep
- Mode
- Recover

For more information on the ACL editor, see the OpenVMS documentation set.

1.57 RMU Set Privilege Command

Command Parameters

root-file-spec

The root file for the database whose root file ACL you are modifying.

Command Qualifiers

Acl[(=ace[,...])]

Specifies one or more ACEs to be modified. When no ACE is specified, the entire ACL is affected. Separate multiple ACEs with commas. When you include the Acl qualifier, the specified ACEs are inserted at the top of the ACL unless you also specify the After qualifier. You cannot specify the Acl qualifier and the Acl_File qualifier on the same RMU command line.

The format of an ACE is as follows:

(Identifier=user-id, Access=access_mask)

The user-id must be one of the following types of identifier:

- A user identification code (UIC) in [group-name,member-name] alphanumeric format
- A user identification code (UIC) in [group-number,member-number] numeric format
- A general identifier, such as SECRETARIES
- A system-defined identifier, such as DIALUP
- Wildcard characters in [*,*] format

Names are not case sensitive. In addition, the Identifier and Access keywords can be abbreviated to one character. For example, the following ACE is valid:

(I=isteward, A=RMU\$ALL)

The access_mask can be any of the following:

- One or more of the Oracle RMU privileges listed in Table 1–1
If more than one privilege is specified, a plus sign (+) must be placed between the privileges.
- The keyword RMU\$ALL
These keywords indicate that you want the user to have all of the RMU privileges. (This keyword has no effect on system file privileges.)

1.57 RMU Set Privilege Command

- The keyword `None`
This keyword indicates that you do not want the user to have any RMU or OpenVMS privileges. If you specify `Acl=(id=username, access=READ+NONE)`, the specified user will have no RMU privileges and no `READ` privileges for the database files.

Acl_File=filename

Specifies a file containing a list of ACEs, with one ACE specified per line. You can use continuation characters to continue an ACE on the next line, and you can include commented lines within the file. Within this file, use the dash (-) as a continuation character and the exclamation point (!) to indicate a comment.

You cannot specify the `Acl_File` qualifier and the `Acl` qualifier on the same RMU command line.

After=ace

Indicates that all ACEs specified with the `Acl` qualifier are to be added after the ACE specified with the `After` qualifier. By default, any ACEs added to the ACL are always placed at the top of the list.

You cannot use this qualifier with the `Edit` qualifier.

Delete[=All]

Indicates that the ACEs specified with the `Acl` qualifier are to be deleted. If no ACEs are specified with the `Acl` qualifier, the entire ACL is deleted. If you specify an ACE that was not specified with the `Acl` qualifier, you are notified that the ACE does not exist, and the delete operation continues.

You cannot use this qualifier with the `Edit` qualifier.

Edit

Invokes the ACL editor and allows you to use the `Journal`, `Keep`, `Mode`, or `Recover` qualifiers. Oracle RMU ignores any other qualifiers you specify with the `Edit` qualifier.

The RMU Set Privilege command with the `Edit` qualifier only functions off line. If you attempt it on line, an error message is generated. This restriction is necessary because the ACL editor requests exclusive write access to the database.

To use the `Edit` qualifier, the `SYS$SHARE:ACLEDTSHR.EXE` image must be installed at system startup time, or, be installed by `RMONSTART.COM`. Contact your system manager if this image is not installed as needed.

For more information on the ACL editor, see the OpenVMS documentation set.

1.57 RMU Set Privilege Command

Journal[=file-spec]

Nojournal

Controls whether a journal file is created from the editing session. By default, a journal file is created if the editing session ends abnormally.

If you omit the file specification, the journal file has the same name as the root file and a file type of .tjl. You can use the Journal qualifier to specify a journal file name that is different from the default. No wildcard characters are allowed in the Journal qualifier file-spec parameter.

You must specify the Edit qualifier to use this qualifier.

Keep[=(Recovery,Journal)]

Determines whether the journal file, the recovery file, or both, are deleted when the editing session ends. The options are:

- Recovery—Saves the journal file used for restoring the ACL.
- Journal—Saves the journal file for the current editing session.

You can shorten the Journal and Recover options to J and R, respectively. If you specify only one option, you can omit the parentheses.

You must specify the Edit qualifier to use this qualifier. If you specify the Edit qualifier but do not specify the Keep qualifier, both the journal file for the current editing session and the journal file used for restoring the ACL are deleted when the editing session ends.

Like=source-root-file-spec

Indicates that the ACL of the root file specified with the Like qualifier is to replace the ACL of the root file specified with the root-file-spec parameter of the RMU Set Privilege command. Any existing ACEs are deleted before the root file ACL specified by the Like qualifier is copied.

You cannot use this qualifier with the Edit qualifier.

Log

Nolog

Directs the RMU Set Privilege command to return both the name of the root file that has been modified by the command and the ACL associated with the database. The default of Nolog suppresses this output.

You cannot use this qualifier with the Edit qualifier.

Mode=[No]Prompt

Determines whether the ACL editor prompts for field values. By default, the ACL editor selects prompt mode.

1.57 RMU Set Privilege Command

You must specify the Edit qualifier to use this qualifier.

New

Indicates that any existing ACE in the ACL of the root file specified with RMU Set Privilege is to be deleted. To use the New qualifier, you must specify a new ACL or ACE with the Acl, Like, or Replace qualifiers.

You cannot use this qualifier with the Edit qualifier.

Recover[=file-spec]

Norecover

Specifies the name of the journal file to be used in a recovery operation. If the file specification is omitted with the Recover qualifier, the journal is assumed to have the same name as the root file and a file type of .tjl. No wildcard characters are allowed with the Recover qualifier file-spec parameter.

The default is the Norecover qualifier, where no recovery is attempted when you invoke the ACL editor to edit a root file ACL.

You must specify Edit to use this qualifier.

Replace=(ace[,...])

Deletes the ACEs specified with the Acl qualifier and replaces them with those specified with the Replace qualifier. Any ACEs specified with the Acl qualifier must exist and must be specified in the order in which they appear in the ACL.

This qualifier cannot be used with the Edit qualifier.

Usage Notes

- You must have the RMU\$SECURITY privilege in the root file ACL for a database or the OpenVMS SECURITY or BYPASS privilege to use the RMU Set Privilege command for the database. The RMU\$SECURITY access is VMS BIT_15 access in the ACE. You can grant yourself BIT_15 access by using the DCL SET ACL command if you have (READ+WRITE+CONTROL) access.
- By default, a root file ACL is created for every Oracle Rdb database. In some cases, the root file ACL may not allow the appropriate Oracle RMU access for the database to all Oracle RMU users. In these situations, you must use the RMU Set Privilege command to modify the root file ACL to give the appropriate Oracle RMU access to Oracle RMU users. Table 1-1 shows the privileges required to access each Oracle RMU command.

1.57 RMU Set Privilege Command

- The root file ACL created by default on each Oracle Rdb database controls only a user's Oracle RMU access to the database (by specifying privileges that will allow a user or group of users access to specific Oracle RMU commands). Root file ACLs do not control a user's access to the database with SQL statements.

A user's access to a database with SQL statements is governed by the privileges granted to the user in the database ACL (the ACL that is displayed using the SQL SHOW PROTECTION ON DATABASE command).

- If you find that the root file ACL has changed, or is not set as expected, it may be because a layered product has manipulated the OpenVMS directory or file ACLs. This can result in the unintentional alteration of an Oracle RMU access right.

For example, Oracle CDD/Repository may use the following ACE:

```
(IDENTIFIER=[*,*],OPTIONS=DEFAULT+PROPAGATE,ACCESS=NONE)
```

If this ACE is propagated to an Oracle Rdb database, such as CDD\$DATABASE or CDD\$TEMPLATE, OpenVMS privileges may be required to manage that database. Or, you can use the RMU Set Privilege command to change the ACL on the affected database.

- If you need to move a database from one system to another, you should be aware that the identifiers used in the database's root file ACL on the source system are not likely to be valid identifiers on the destination system. Thus, if the database root file ACL from the source system is moved to the destination system without modification, only those users with the same identifiers on both systems have the same Oracle RMU access to the database on the destination system as they had to the database on the source system.

For example, suppose that the mf_personnel database with the following root file ACL is moved from its current system to another node. If the database root file ACL is moved without modification to the destination node, the users USER, USER2, USER3, USER4, and USER5 will not have any Oracle RMU access to the database on the destination node unless they have the same identities on the destination node.

```
$ RMU/SHOW PRIVILEGE MF_PERSONNEL.RDB
Object type: file, Object name:SQL_USER:[USER]MF_PERSONNEL.RDB;1,
on 31-MAR-1992 15:48:36.24
```

1.57 RMU Set Privilege Command

```
( IDENTIFIER= [SQL, USER] , ACCESS=READ+WRITE+CONTROL+RMU$ALTER+
RMU$ANALYZE+RMU$BACKUP+RMU$CONVERT+RMU$COPY+RMU$DUMP+RMU$LOAD+
RMU$MOVE+RMU$OPEN+RMU$RESTORE+RMU$SECURITY+RMU$SHOW+RMU$UNLOAD+
RMU$VERIFY)
( IDENTIFIER= [SQL, USER2] , ACCESS=RMU$ANALYZE+RMU$OPEN+RMU$VERIFY)
( IDENTIFIER= [SQL, USER3] , ACCESS=RMU$SECURITY)
( IDENTIFIER= [RDB, USER4] , ACCESS=RMU$BACKUP+RMU$CONVERT+RMU$DUMP+
RMU$RESTORE)
( IDENTIFIER= [RDB, USER5] , ACCESS=RMU$LOAD+RMU$SHOW)
( IDENTIFIER= [*, *] , ACCESS=NONE)
```

- The following list describes some ways to move a database from one node to another and explains what happens to the original root file ACL in each scenario:
 - RMU Restore command

First, use the RMU Backup command to back up the database on the source node and to create an .rbf file. Then, copy the .rbf file from the source node to the destination node. When you use the RMU Restore command to re-create the database from the source node on the destination node, the database on the destination node will have the same root file ACL as the database on the source node. If a user with the RMU\$SECURITY privilege in the root file ACL on the source node has the same identifier on the destination node, that user can modify the root file ACL on the destination node to grant users the privileges they need for Oracle RMU access to the database. Otherwise, a user with one of the OpenVMS override privileges (SECURITY or BYPASS) needs to modify the root file ACL.
 - RMU Restore command with the Noacl qualifier

First, use the RMU Backup command to back up the database on the source node and to create an .rbf file. Then, copy the .rbf file from the source node to the destination node. When you use the RMU Restore command with the Noacl qualifier to re-create the database from the source node on the destination node, the database on the destination node is created with an empty root file ACL. A user with one of the OpenVMS override privileges (SECURITY or BYPASS) needs to modify the root file ACL to grant users the privileges they need for Oracle RMU access to the database.
 - SQL IMPORT statement

First, use the SQL EXPORT statement on the source node to create an .rbr file. Then, copy the .rbr file from the source node to the destination node. When you use the SQL IMPORT statement on the destination node, the imported database is created with the same root file ACL as existed on the database on the source node. If a user with the

1.57 RMU Set Privilege Command

RMU\$SECURITY privilege in the root file ACL on the source node has the same identifier on the destination node, that user can modify the root file ACL on the destination node to grant users the privileges they need for Oracle RMU access to the database. Otherwise, a user with one of the OpenVMS override privileges (SECURITY or BYPASS) needs to modify the root file ACL to grant users the privileges they need for Oracle RMU access to the database.

- SQL IMPORT NO ACL statement

First, use the SQL EXPORT statement on the source node to create an .rbr file. Then, copy the .rbr file from the source node to the destination node. When you use the SQL IMPORT NO ACL statement on the destination node, the imported database is created with a root file ACL that contains one ACE. The single ACE will grant the OpenVMS READ, WRITE, and CONTROL privileges plus all the Oracle RMU privileges to the user who performed the IMPORT operation. The user who performed the IMPORT operation can modify the root file ACL to grant users the privileges they need for Oracle RMU access to the database.

Examples

Example 1

The following example assumes that the user with a user identification code (UIC) of [SQL,USER] has created the mf_test_db database and is therefore the owner of the database. After creating the mf_test_db database, the owner displays the root file ACL for the database. Then the owner grants Oracle RMU privileges to database users. The Oracle RMU privileges granted to each type of user depend on the type of Oracle RMU access the user needs to the database.

```
$! Note that by default the owner (the user with a UIC of [SQL,USER])
$! is granted all the Oracle RMU privileges in the root file
$! ACL and no other users are granted any Oracle RMU privileges.

$ RMU/SHOW PRIVILEGE MF_TEST_DB.RDB
Object type: file, Object name: SQL_USER:[USER]MF_TEST_DB.RDB;1,
on 30-MAR-1996 15:51:55.79
```

1.57 RMU Set Privilege Command

```
(IDENTIFIER=[SQL,USER],ACCESS=READ+WRITE+CONTROL+RMU$ALTER+
RMU$ANALYZE+RMU$BACKUP+RMU$CONVERT+RMU$COPY+RMU$DUMP+RMU$LOAD+
RMU$MOVE+RMU$OPEN+RMU$RESTORE+RMU$SECURITY+RMU$SHOW+RMU$UNLOAD+
RMU$VERIFY)
$!
$! The owner uses the RMU Set Privilege command and the After
$! qualifier to grant the RMU$ANALYZE, RMU$OPEN, and
$! RMU$VERIFY privileges to a user with a UIC of [SQL,USER2].
$! This user will serve as the database administrator for the
$! mf_test_db database.

$ RMU/SET PRIVILEGE/ACL=(IDENTIFIER=[SQL,USER2],ACCESS=RMU$ANALYZE -
_$ +RMU$OPEN+RMU$VERIFY) -
_$ /AFTER=(IDENTIFIER=[SQL,USER]) /LOG MF_TEST_DB.RDB
%RMU-I-MODIFIED, SQL_USER:[USER]MF_TEST_DB.RDB;1 modified

$!
$! Next, the owner grants the RMU$SECURITY privilege to a user with a
$! UIC of [SQL,USER3]. This gives the user USER3 the ability
$! to grant other users the appropriate privileges they need for
$! accessing the database with Oracle RMU commands. Because both
$! the database creator and user USER3 have the RMU$SECURITY
$! privilege, both of them can modify the root file ACL for the
$! database.

$ RMU/SET PRIVILEGE/ACL=(IDENTIFIER=[SQL,USER3],ACCESS=RMU$SECURITY) -
_$ /AFTER=(IDENTIFIER=[SQL,USER2]) /LOG MF_TEST_DB.RDB
%RMU-I-MODIFIED, SQL_USER:[USER]MF_TEST_DB.RDB;1 modified
$!
$! The user with a UIC of [RDB,USER4], who will serve as the database
$! operator, is granted the RMU$BACKUP, RMU$CONVERT, RMU$DUMP, and
$! RMU$RESTORE privileges:
$ RMU/SET PRIVILEGE/ACL=(IDENTIFIER=[RDB,USER4],ACCESS=RMU$BACKUP -
_$ +RMU$CONVERT+RMU$DUMP+RMU$RESTORE) -
_$ /AFTER=(IDENTIFIER=[SQL,USER3]) /LOG MF_TEST_DB.RDB
%RMU-I-MODIFIED, SQL_USER:[USER]MF_TEST_DB.RDB;1 modified
$!
$! The RMU$LOAD and RMU$SHOW privileges are granted to the user
$! with a UIC of [RDB,USER5]. This user will be writing programs
$! that load data into the database.

$ RMU/SET PRIVILEGE/ACL=(IDENTIFIER=[RDB,USER5],ACCESS=RMU$LOAD -
_$ +RMU$SHOW) /AFTER=(IDENTIFIER=[RDB,USER4]) MF_TEST_DB.RDB
%RMU-I-MODIFIED, SQL_USER:[USER]MF_TEST_DB.RDB;1 modified
$!
$! No privileges are granted to all other users.

$ RMU/SET PRIVILEGE/ACL=(IDENTIFIER=[*,*],ACCESS=NONE) -
_$ /AFTER=(IDENTIFIER=[RDB,USER5]) /LOG MF_TEST_DB.RDB
%RMU-I-MODIFIED, SQL_USER:[USER]MF_TEST_DB.RDB;1 modified
$!
$! The RMU/SHOW PRIVILEGE command displays the root file ACL for the
$! mf_test_db database.

$ RMU/SHOW PRIVILEGE MF_TEST_DB.RDB
Object type: file, Object name: SQL_USER:[USER]MF_TEST_DB.RDB;1,
on 30-MAR-1996 15:52:17.03
```

1.57 RMU Set Privilege Command

```
(IDENTIFIER=[SQL,USER],ACCESS=READ+WRITE+CONTROL+RMU$ALTER+
RMU$ANALYZE+RMU$BACKUP+RMU$CONVERT+RMU$COPY+RMU$DUMP+RMU$LOAD+
RMU$MOVE+RMU$OPEN+RMU$RESTORE+RMU$SECURITY+RMU$SHOW+RMU$UNLOAD+
RMU$VERIFY)
(IDENTIFIER=[SQL,USER2],ACCESS=RMU$ANALYZE+RMU$OPEN+RMU$VERIFY)
(IDENTIFIER=[SQL,USER3],ACCESS=RMU$SECURITY)
(IDENTIFIER=[RDB,USER4],ACCESS=RMU$BACKUP+RMU$CONVERT+RMU$DUMP+
RMU$RESTORE)
(IDENTIFIER=[RDB,USER5],ACCESS=RMU$LOAD+RMU$SHOW)
(IDENTIFIER=[*,*],ACCESS=NONE)
```

Example 2

The following command adds an ACE for the user with a UIC of [RDB,USER1] to the root file ACL for the personnel database. This ACE grants [RDB,USER1] the RMU\$BACKUP privilege for the personnel database. The RMU\$BACKUP privilege allows user [RDB,USER1] to access the RMU Backup, RMU Backup After_Journal, and RMU Checkpoint commands for the personnel database.

```
$ RMU/SET PRIVILEGE/ACL=(IDENTIFIER=[RDB,USER1],ACCESS=RMU$BACKUP) -
_ $ PERSONNEL.RDB
```

Example 3

The Replace qualifier in the following example causes the ACE in the root file ACL for the user with a UIC of [RDB,USER4] to be replaced by the ACE specified for the user with a UIC of [SQL,USER6]:

```
$ RMU/SET PRIVILEGE/ACL=(IDENTIFIER=[RDB,USER4]) -
_ $ /REPLACE=(IDENTIFIER=[SQL,USER6],ACCESS=RMU$BACKUP+RMU$CONVERT -
_ $ +RMU$DUMP+RMU$RESTORE)/LOG MF_TEST_DB.RDB
%RMU-I-MODIFIED, SQL_USER:[USER]MF_TEST_DB.RDB;1 modified
$!
$ RMU/SHOW PRIVILEGE MF_TEST_DB.RDB
Object type: file, Object name: SQL_USER:[USER]MF_TEST_DB.RDB;1,
on 30-MAR-1996 15:52:23.92
```

```
(IDENTIFIER=[SQL,USER],ACCESS=READ+WRITE+CONTROL+RMU$ALTER+
RMU$ANALYZE+RMU$BACKUP+RMU$CONVERT+RMU$COPY+RMU$DUMP+RMU$LOAD+
RMU$MOVE+RMU$OPEN+RMU$RESTORE+RMU$SECURITY+RMU$SHOW+RMU$UNLOAD+
RMU$VERIFY)
(IDENTIFIER=[SQL,USER2],ACCESS=RMU$ANALYZE+RMU$OPEN+RMU$VERIFY)
(IDENTIFIER=[SQL,USER3],ACCESS=RMU$SECURITY)
(IDENTIFIER=[SQL,USER6],ACCESS=RMU$BACKUP+RMU$CONVERT+RMU$DUMP+
RMU$RESTORE)
(IDENTIFIER=[RDB,USER5],ACCESS=RMU$LOAD+RMU$SHOW)
(IDENTIFIER=[*,*],ACCESS=NONE)
```

1.57 RMU Set Privilege Command

Example 4

The Delete qualifier in the following example causes the ACE for the user with a UIC of [RDB,USER5] to be deleted from the root file ACL for the mf_test_db database:

```
$ RMU/SET PRIVILEGE/ACL=(IDENTIFIER=[RDB,USER5]) -
_ $ /DELETE/LOG MF_TEST_DB.RDB
%RMU-I-MODIFIED, SQL_USER:[USER]MF_TEST_DB.RDB;1 modified
$!
$ RMU/SHOW PRIVILEGE MF_TEST_DB.RDB
Object type: file, Object name: SQL_USER:[USER]MF_TEST_DB.RDB;1,
on 30-MAR-1996 15:52:29.07

  (IDENTIFIER=[SQL,USER],ACCESS=READ+WRITE+CONTROL+RMU$ALTER+
  RMU$ANALYZE+RMU$BACKUP+RMU$CONVERT+RMU$COPY+RMU$DUMP+RMU$LOAD+
  RMU$MOVE+RMU$OPEN+RMU$RESTORE+RMU$SECURITY+RMU$SHOW+RMU$UNLOAD+
  RMU$VERIFY)
  (IDENTIFIER=[SQL,USER2],ACCESS=RMU$ANALYZE+RMU$OPEN+RMU$VERIFY)
  (IDENTIFIER=[SQL,USER3],ACCESS=RMU$SECURITY)
  (IDENTIFIER=[SQL,USER6],ACCESS=RMU$BACKUP+RMU$CONVERT+RMU$DUMP+
  RMU$RESTORE)
  (IDENTIFIER=[*,*],ACCESS=NONE)
```

Example 5

In the following example, the Like qualifier copies the root file ACL from the mf_test_db database to the test_db database. As part of this operation, the original root file ACL for the test_db database is deleted.

```
$ RMU/SHOW PRIVILEGE TEST_DB.RDB
Object type: file, Object name: SQL_USER:[USER]TEST_DB.RDB;1, on
30-MAR-1996 15:52:31.48

  (IDENTIFIER=[SQL,USER],ACCESS=READ+WRITE+CONTROL+RMU$ALTER+
  RMU$ANALYZE+RMU$BACKUP+RMU$CONVERT+RMU$COPY+RMU$DUMP+RMU$LOAD+
  RMU$MOVE+RMU$OPEN+RMU$RESTORE+RMU$SECURITY+RMU$SHOW+RMU$UNLOAD+
  RMU$VERIFY)
$ !
$ RMU/SHOW PRIVILEGE MF_TEST_DB.RDB
Object type: file, Object name: SQL_USER:[USER]MF_TEST_DB.RDB;1,
on 30-MAR-1996 15:52:33.86

  (IDENTIFIER=[SQL,USER],ACCESS=READ+WRITE+CONTROL+RMU$ALTER+
  RMU$ANALYZE+RMU$BACKUP+RMU$CONVERT+RMU$COPY+RMU$DUMP+RMU$LOAD+
  RMU$MOVE+RMU$OPEN+RMU$RESTORE+RMU$SECURITY+RMU$SHOW+RMU$UNLOAD+
  RMU$VERIFY)
  (IDENTIFIER=[SQL,USER2],ACCESS=RMU$ANALYZE+RMU$OPEN+RMU$VERIFY)
  (IDENTIFIER=[SQL,USER3],ACCESS=RMU$SECURITY)
  (IDENTIFIER=[SQL,USER6],ACCESS=RMU$BACKUP+RMU$CONVERT+RMU$DUMP+
  RMU$RESTORE)
  (IDENTIFIER=[*,*],ACCESS=NONE)
$ !
$ RMU/SET PRIVILEGE/LIKE=MF_TEST_DB.RDB/LOG TEST_DB.RDB
%RMU-I-MODIFIED, SQL_USER:[USER]TEST_DB.RDB;1 modified
```

1.57 RMU Set Privilege Command

```
$!  
$ RMU/SHOW PRIVILEGE TEST_DB.RDB  
Object type: file, Object name: SQL_USER:[USER]TEST_DB.RDB;1, on  
30-MAR-1996 15:52:41.36  
  
  (IDENTIFIER=[SQL,USER],ACCESS=READ+WRITE+CONTROL+RMU$ALTER+  
  RMU$ANALYZE+RMU$BACKUP+RMU$CONVERT+RMU$COPY+RMU$DUMP+RMU$LOAD+  
  RMU$MOVE+RMU$OPEN+RMU$RESTORE+RMU$SECURITY+RMU$SHOW+RMU$UNLOAD+  
  RMU$VERIFY)  
  (IDENTIFIER=[SQL,USER2],ACCESS=RMU$ANALYZE+RMU$OPEN+RMU$VERIFY)  
  (IDENTIFIER=[SQL,USER3],ACCESS=RMU$SECURITY)  
  (IDENTIFIER=[SQL,USER6],ACCESS=RMU$BACKUP+RMU$CONVERT+RMU$DUMP+  
  RMU$RESTORE)  
  (IDENTIFIER=[*,*],ACCESS=NONE)
```

Example 6

The New qualifier in the following example deletes all the existing ACEs and the Acl qualifier specifies a new ACE for the root file ACL for the mf_test_db database. Note that after the RMU Set Privilege command in this example is issued, only the user with a UIC of [SQL,USER2] or a user with an OpenVMS override privilege would be able to display the root file ACL for the mf_test_db database.

```
$ RMU/SHOW PRIVILEGE MF_TEST_DB.RDB  
Object type: file, Object name: SQL_USER:[USER]MF_TEST_DB.RDB;1,  
on 30-MAR-1996 15:52:44.50  
  
  (IDENTIFIER=[SQL,USER],ACCESS=READ+WRITE+CONTROL+RMU$ALTER+  
  RMU$ANALYZE+RMU$BACKUP+RMU$CONVERT+RMU$COPY+RMU$DUMP+RMU$LOAD+  
  RMU$MOVE+RMU$OPEN+RMU$RESTORE+RMU$SECURITY+RMU$SHOW+RMU$UNLOAD+  
  RMU$VERIFY)  
  (IDENTIFIER=[SQL,USER2],ACCESS=RMU$ANALYZE+RMU$OPEN+RMU$VERIFY)  
  (IDENTIFIER=[SQL,USER3],ACCESS=RMU$SECURITY)  
  (IDENTIFIER=[SQL,USER6],ACCESS=RMU$BACKUP+RMU$CONVERT+RMU$DUMP+  
  RMU$RESTORE)  
  (IDENTIFIER=[*,*],ACCESS=NONE)  
$!  
$ RMU/SET PRIVILEGE/NEW -  
_ $ /ACL= (IDENTIFIER=[SQL,USER2],ACCESS=READ+WRITE+CONTROL+ -  
_ $ RMU$ALTER+RMU$ANALYZE+RMU$BACKUP+RMU$CONVERT+RMU$COPY+ -  
_ $ RMU$DUMP+RMU$LOAD+RMU$MOVE+RMU$OPEN+RMU$RESTORE+RMU$SHOW+ -  
_ $ RMU$UNLOAD+RMU$VERIFY)/LOG MF_TEST_DB.RDB  
%RMU-I-MODIFIED, SQL_USER:[USER]MF_TEST_DB.RDB;1 modified
```

1.58 RMU Set Row_Cache Command

1.58 RMU Set Row_Cache Command

Allows you to enable or disable the database Row Cache feature and to modify certain parameters on a per-cache basis.

Format

RMU/Set Row_Cache root-file-spec

Command Qualifiers

/Alter=(Name=cache-name,option(...))
/Disable
/Enable
/[No]Log

Defaults

See Description
None
None
Current DCL verify value

Description

You can use the RMU Set Row_Cache command to allow the database Row Cache feature to be enabled or disabled without requiring that the database be opened.

You can also use the Alter parameter to make modifications to one cache at a time.

Command Parameters

root-file-spec

Specifies the database root file for which you want to modify the Row Cache feature.

Command Qualifiers

Alter=(Name=cachename,option(...))

Specifies the action to take on the named cache. You must specify the cache name and at least one other option:

- Name=cachename
Name of the cache to be modified. The cache must already be defined in the database. You must specify the cache name if you use the Alter qualifier.
- Disable
Disables the named cache.

1.58 RMU Set Row_Cache Command

- **Enable**
Enables the named cache.
- **Shared_Memory=keyword**
Specifies the shared memory type and parameters for the cache. Valid keywords are:
 - **Type=option**
Specify one of the following options:
 - * **Process**
Specifies traditional shared memory global section, which means that the database global section is located in process (P0) address space and may be paged from the process working set as needed.
 - * **Resident**
Specifies that the database global section is memory resident in process (P0) address space using OpenVMS Alpha shared page tables. This means that the global section is fully resident, or pinned, in memory, and uses less physical and virtual memory (for process page tables) than a traditional shared memory global section.
 - **Rad_Hint=n**
NoRad_Hint
Indicates a request that memory should be allocated from the specified OpenVMS Alpha Resource Affinity Domain (RAD). This keyword specifies a hint to Oracle Rdb and OpenVMS about where memory should be physically allocated. It is possible that if the requested memory is not available, it will be allocated from other RADs in the system. For systems that do not support RADs, a Rad_Hint value of zero is valid.

The Rad_Hint keyword is valid only when the shared memory type is set to Resident. If you set the shared memory type to System or Process, you disable any previously defined RAD hint.

Use Norad_Hint to disable the RAD hint.

Note

OpenVMS support for RADs is available only on the AlphaServer GS series systems. For more information about using RADs, refer to the *OpenVMS Alpha Partitioning and Galaxy Guide*.

1.58 RMU Set Row_Cache Command

- **Slot_Count=n**
Specifies the number of slots in the cache.
- **Slot_Size=n**
Specifies the size (in bytes) of each slot in the cache.
- **Snapshot_Slot_Count=n**
Specifies the number of snapshot slots in the cache. A value of zero disables the snapshot portion for the specified cache.
- **Working_Set_Count=n**
Specifies the number of working set entries for the cache. Valid values are from 1 to 100.

Disable

Disables row caching. Do not use with the Enable qualifier.

Enable

Enables row caching. Do not use with the Disable qualifier.

Log

Nolog

Specifies whether the processing of the command is reported to SYS\$OUTPUT. Specify the Log qualifier to request log output and the Nolog qualifier to prevent it. If you specify neither, the default is the current setting of the DCL verify switch.

Usage Notes

- This command requires exclusive database access (the database cannot be open or accessed by other users).
- The Alter qualifier can be specified multiple times on the command line. Each use of the qualifier operates on a unique cache.
- Only one value can be supplied with the Rad_Hint keyword. The indicated RAD must contain memory.
- When shared memory is set to System (with Galaxy enabled) or to Resident, then the process that opens the database must be granted the VMS\$MEM_RESIDENT_USER identifier.

1.58 RMU Set Row_Cache Command

- For applications that can be partitioned into one or more RADs, the Rad_Hint qualifier allows additional control over exactly where memory for caches and global sections is allocated. This control can permit increased performance if all application processes run in the same RAD, and the database and row cache global sections also reside in that same RAD.
- When Resident shared memory is specified, the global demand-zero pages are always resident in memory and are not backed up by any file on any disk. The pages are not placed into the process's working set list when the process maps to the global section and the virtual memory is referenced by the process. The pages are also not charged against the process's working set quota or against any page-file quota.
- To save physical memory, Oracle Rdb generally attempts to create and use shared page tables when creating large resident global sections.
- The total number of rows for any individual cache (the combination of live rows and snapshot rows) is limited to 2,147,483,647.

Examples

Example 1

The following example sets the slot count on cache "mycache".

```
$ RMU/SET ROW_CACHE/ALTER=(NAME=mycache, SLOT_COUNT=8888)
```

Example 2

This command disables all caches.

```
$ RMU/SET ROW_CACHE/DISABLE
```

Example 3

The following sample specifies that cache "cache2" should use RAD 2.

```
$ RMU/SET ROW_CACHE/ALTER=(NAME=cache2, SHARED_MEM=(TYPE=RESIDENT, -  
_ $ RAD_HINT=2)
```

Example 4

This example disables cache "seacache".

```
$ RMU/SET ROW_CACHE/ALTER=(NAME=seacache, DISABLE)
```

Example 5

1.58 RMU Set Row_Cache Command

This example shows show multiple uses of the Alter qualifier.

```
$ RMU /SET ROW_CACHE MF_PERSONNEL/ALTER=(NAME = RDB$SYS_CACHE, -  
_$_$ SLOT_COUNT = 800, WINDOW_COUNT = 25) -  
_$_$ /ALTER= (NAME = RESUMES, SLOT_SIZE=500, WORKING_SET_COUNT = 15)
```

Example 6

The following example modifies the database MYDB to set the snapshot slot count for the cache EMPL_IDX to 25000 slots and disables snapshots in cache for the SALES cache.

```
$ RMU /SET ROW_CACHE DGA0:[DB]MYDB.RDB -  
_$_$ /ALTER=(NAME=EMPL_IDX, SNAPSHOT_SLOT_COUNT=25000) -  
_$_$ /ALTER=(NAME=SALES, SNAPSHOT_SLOT_COUNT=0)
```

1.59 RMU Set Server Command

Allows you to identify output files for several database server processes.

Format

RMU/Set Server server-type root-file-spec

<u>Command Qualifiers</u>	<u>Defaults</u>
/Log	None
/Output=file-name	None

Description

You can use the Set Server/Output command to identify output log file names and locations for various database server processes. The following table shows valid values for the server-type parameter and the corresponding logical name.

1.59 RMU Set Server Command

Table 1–15 Server Types and Logical Names

Server	Server-type	Logical Name
AIJ Backup Server	ABS	RDM\$BIND_BIND_ABS_OUTPUT_FILE
AIJ Log Server	ALS	RDM\$BIND_BIND_ALS_OUTPUT_FILE
AIJ Log Roll-Forward Server	LRS	RDM\$BIND_LRS_OUTPUT_FILE
AIJ Log Catch-Up Server	LCS	RDM\$BIND_LCS_OUTPUT_FILE
Database Recovery Server	DBR	RDM\$BIND_DBR_LOG_FILE
Row Cache Server	RCS	RDM\$BIND_RCS_LOG_FILE

If the output file specification is empty (Output=""), the log file information for that server will be deleted from the database.

If an existing logical name specifies an output file name for the specified server process, it takes precedence over the file name designated in the Set Server/Output command.

Command Parameters

server-type

Identifies the server process for which you want to log output. Refer to Table 1–15 for a list of valid server types and their corresponding logical names.

root-file-spec

Specifies the database root file for which you want to specify the server process output file.

Command Qualifiers

Log

Displays a log message at the completion of the RMU Set command.

Output

Identifies the output log file for several database server processes.

1.59 RMU Set Server Command

Examples

Example 1

This example specifies the output file for the row cache server and displays a log message when the procedure finishes.

```
$ RMU /SET SERVER RCS /OUTPUT=RCS_PID.LOG /LOG DUA0:[DB]MYDB.RDB
```

Example 2

This example specifies the output file for the AIJ log server.

```
$ RMU /SET SERVER ALS /OUTPUT=ALS$LOGS:ALS_DB1.LOG DUA0:[DB1]MFP.RDB
```

Example 3

This example deletes the log file information in the database for the AIJ log roll-forward server.

```
$ RMU /SET SERVER LRS /OUTPUT=" " DUA0:[ZDB]ZDB.RDB
```

Example 4

This example specifies the output file for the database recovery server.

```
$ RMU /SET SERVER DBR /OUTPUT=DBR$LOGS:DBR.LOG DUA0:[ADB]ADB.RDB
```

1.60 RMU Set Shared_Memory Command

1.60 RMU Set Shared_Memory Command

Allows you to alter the database shared memory configuration without requiring that the database be open.

Format

RMU/Set Shared_Memory root-file-spec

Command Qualifiers

/[No]Log
/[No]Rad_Hint=n
/Type={Process|Resident|System}

Defaults

Current DCL verify value
None
None

Description

You can use the RMU Set Shared_Memory command to alter the database shared memory configuration without requiring that the database be open.

Command Parameters

root-file-spec

Specifies the database root file for which you want to modify the shared memory configuration.

Command Qualifiers

Log

Nolog

Specifies whether the processing of the command is reported to SYS\$OUTPUT. Specify the Log qualifier to request log output and the Nolog qualifier to prevent it. If you specify neither, the default is the current setting of the DCL verify switch.

Rad_Hint=n

Norad_Hint

Indicates a request that memory should be allocated from the specified OpenVMS Alpha Resource Affinity Domain (RAD). This qualifier specifies a hint to Oracle Rdb and OpenVMS about where memory should be physically allocated. It is possible that if the requested memory is not available, it will be allocated from other RADs in the system. For systems that do not support RADs, a Rad_Hint value of zero is valid.

1.60 RMU Set Shared_Memory Command

The Rad_Hint qualifier is only valid when the shared memory type is set to Resident. If you set the shared memory type to System or Process, you disable any previously defined RAD hint.

Use the Norad_Hint qualifier to disable the RAD hint.

Note

OpenVMS support for RADs is available only on the AlphaServer GS series systems. For more information about using RADs, refer to the *OpenVMS Alpha Partitioning and Galaxy Guide*.

Type=option

If you use the Type qualifier, you must specify one of the following options:

- Process
Specifies traditional shared memory global section, which means that the database global section is located in process (P0) address space and may be paged from the process working set as needed.
- Resident
Specifies that the database global section is memory resident in process (P0) address space using OpenVMS Alpha shared page tables. This means that the global section is fully resident, or pinned, in memory, and uses less physical and virtual memory (for process page tables) than a traditional shared memory global section.
- System
Specifies that the database global section is located in OpenVMS Alpha system space, which means that the section is fully resident, or pinned, in memory, does not use process (P0) address space, and does not affect the quotas of the working set of a process.

Usage Notes

- This command requires exclusive database access (the database cannot be open or accessed by other users).
- Only one value can be supplied to the Rad_Hint qualifier. The indicated RAD must contain memory.

1.60 RMU Set Shared_Memory Command

- When shared memory is set to System (with Galaxy enabled) or to Resident, then the process that opens the database must be granted the VMS\$MEM_RESIDENT_USER identifier.
- For applications that can be partitioned into one or more RADs, the Rad_Hint qualifier allows additional control over exactly where memory for caches and global sections is allocated. This control can permit increased performance if all application processes run in the same RAD, and the database and row cache global sections also reside in that same RAD.
- When Resident shared memory is specified, the global demand-zero pages are always resident in memory and are not backed up by any file on any disk. The pages are not placed into the process's working set list when the process maps to the global section and the virtual memory is referenced by the process. The pages are also not charged against the process's working set quota or against any page-file quota.
- To save physical memory, Oracle Rdb generally attempts to create and use shared page tables when creating large resident global sections.

Examples

Example 1

The following example sets the memory type to Resident and requests that it be put in RAD 4.

```
$ RMU/SET SHARED_MEMORY/TYPE=RESIDENT/RAD_HINT=4
```

Example 2

This example specifies that system space buffers are to be used.

```
$ RMU/SET SHARED_MEMORY/TYPE=SYSTEM
```

Example 3

The following example specifies that process address space shared memory is to be used.

```
$ RMU/SET SHARED_MEMORY/TYPE=PROCESS/LOG
```

1.61 RMU Show Command

Displays current information about security audit characteristics, version numbers, active databases, active users, active recovery-unit files, after-image journal files, corrupt areas and pages, optimizer statistics, or database statistics related to database activity on your node. Note that, with the exception of the RMU Show Locks and RMU Show Users commands, the RMU Show commands display information for your current node only in a clustered environment.

Oracle RMU provides the following Show commands:

- After_Journal
- Audit
- Corrupt_Pages
- Locks
- Optimizer_Statistics
- Privilege
- Statistics
- System
- Users
- Version

Each show command is described in a separate section.

RMU Show After_Journal Command

1.61.1 RMU Show After_Journal Command

Displays the after-image journal configuration in the form required for the Aij_Options qualifier. You can use the Aij_Options qualifier with the RMU Copy_Database, RMU Move_Area, RMU Restore, RMU Restore Only_Root, and RMU Set After_Journal commands. Optionally, this command initializes the RDM\$AIJ_BACKUP_SEQNO, RDM\$AIJ_COUNT, RDM\$AIJ_CURRENT_SEQNO, RDM\$AIJ_ENDOFFILE, RDM\$AIJ_FULLNESS, RDM\$AIJ_LAST_SEQNO, RDM\$AIJ_NEXT_SEQNO, and RDM\$AIJ_SEQNO global process symbols.

Note

Prior to Oracle Rdb Version 6.0, the ability to display an .aij specification was provided through the Rdbalter Display Root command. The Rdbalter Display Root command no longer provides this capability.

Format

RMU/Show After_Journal root-file-spec

Command Qualifiers

/[No]Backup_Context
/Output[=file-name]

Defaults

/Nobackup_Context
SYS\$OUTPUT

Description

The output of the RMU Show After_Journal command appears in the form shown in Figure 1–1. This is the form required by the Aij_Options qualifier for the RMU Copy_Database, Move_Area, and Restore commands. When you issue the RMU Show After_Journal command, you may see fewer items than shown in Figure 1–1; some options do not appear unless you specified them when you created your after image journal file configuration (for example, with the RMU Set After_Journal command).

RMU Show After_Journal Command

Figure 1–1 Output from the RMU Show After_Journal Command

```
Journal [Is] {Enabled | Disabled} -  
[Reserve n] -  
[Allocation [Is] n] -  
[Extent [Is] n] -  
[Overwrite [Is] {Enabled|Disabled}] -  
[Shutdown_Timeout [Is] n] -  
[Notify [Is] {Enabled|Disabled}] -  
[Backups [Are] {Manual|Automatic}] -  
[[No]Quiet_Point] [File filename] -  
[Cache [Is] {Enabled File filename|Disabled}]  
Add [Journal] journal-name -  
! File file-specification  
File filename -  
[Allocation [Is] n] -  
[Backup_File filename] -  
[Edit_String [Is] (edit-string-options)]
```

When you use the output from the Show After_Journal command as a template for the Aij_Options qualifier of the RMU Copy_Database, Move_Area, and Restore commands, note the following regarding the syntax:

- As shown in Figure 1–1, you can use the DCL continuation character (-) at the end of each line in the Journal and Add clauses. Although continuation characters are not required if you can fit each clause (Journal or Add clause) on a single line, using them might improve readability.
- The Journal Is clause must precede the Add clause.
- Because the Journal clause and the Add clause are two separate clauses, a continuation character should not be used between the last option in the Journal clause and the Add clause (or clauses).
- The journal options file can contain one Journal clause only, but it can contain several Add clauses. However, the number of Add clauses cannot exceed the number of reservations made for .aij files. In addition, if you are enabling journaling, you must add at least one journal.
- You can specify only one of each option (for example, one Extent clause, one Cache clause, and so on) for the Journal Is clause.

The clauses and options have the following meaning:

- **Journal Is Enabled**
Enables after-image journaling. At least one Add clause must follow. If this option is omitted, the current journaling state is maintained.

RMU Show After_Journal Command

- **Journal Is Disabled**

Disables after-image journaling. You can specify other options or Add clauses but they do not take effect until journaling is enabled. The Add clause is optional. If this option is omitted, the current journaling state is maintained.
- **Reserve n**

Allocates space for an .aij file name for a maximum of *n* .aij files. By default, no reservations are made. Note that you cannot reserve space in a single-file database for .aij files by using this option with the RMU Move_Area command with the Aij_Options qualifier. After-image journal file reservations for a single-file database can be made only when you use the RMU Convert, RMU Restore, or RMU Copy_Database commands.
- **Allocation Is n**

Specifies the size (in blocks) of each .aij file. If this option is omitted, the default allocation size is 512 blocks. The maximum allocation size you can specify is eight million blocks.

See the *Oracle Rdb Guide to Database Maintenance* for guidance on setting the allocation size.
- **Extent Is n**

Specifies the maximum size to extend an .aij journal if it is, or becomes, an extensible .aij journal (in blocks). (If the number of available after-image journal files falls to one, extensible journaling is employed.)

If there is insufficient free space on the .aij journal device, the journal is extended using a smaller extension value than specified. However, the minimum, and default, extension size is 512 blocks.

See the *Oracle Rdb Guide to Database Maintenance* for guidance on setting the extent size.
- **Overwrite Is Enabled**

Enables overwriting of journals before they have been backed up. If this option is omitted, overwriting is disabled.

This option is ignored if only one .aij file is available. When you specify the Overwrite Is Enabled option it is activated only when two or more .aij files are, or become, available.
- **Overwrite Is Disabled**

Disables overwriting of journals before they have been backed up. If this option is omitted, overwriting is disabled.

RMU Show After_Journal Command

- **Shutdown_Timeout Is n**

Sets the delay from the time a journal failure is detected until the time the database aborts all access and shuts itself down. The value *n* is in minutes. If this option is omitted, the shutdown timeout is 60 minutes. The maximum value you can specify is 4320 minutes.
- **Notify Is Enabled**

Enables operator notification when the journal state changes. If this option is omitted, operator notification is disabled.
- **Notify Is Disabled**

Disables operator notification when the journal state changes. If this option is omitted, operator notification is disabled.
- **Backups Are Manual**

Automatic backup operations are not enabled. This is the default behavior.
- **Backups Are Automatic [File filename]**

Automatic backup operations are triggered by the filling of a journal. The backup file will have the specified file name unless a different file name or an edit string is specified in the Add clause. If this option is omitted, backup operations are manual.
- **Edit String Is (edit-string-options)**

Specifies a default edit string to apply to the backup file when an .aij is backed up automatically. See the description of the Edit_Filename keyword in Section 1.50 for a description of the available options. An Edit_String that appears with the definition of an added journal takes precedence over this edit string.
- **Quiet_Point**

Specifies that the after-image journal backup operation is to acquire the quiet-point lock prior to performing an .aij backup operation for the specified database.
- **Noquiet_Point**

Specifies that the after-image journal backup operation will not acquire the quiet-point lock prior to performing an .aij backup operation for the specified database.

RMU Show After_Journal Command

- **Cache Is Enabled File filename**

Specifies that a journal cache file should be used. The cache file must reside on a nonvolatile solid-state disk. If it does not, caching is ineffectual. See Section 1.50 for information on what happens if the cache file becomes inaccessible.

By default, caching is disabled.
- **Cache Is Disabled**

Specifies that a journal cache file should not be used. This is the default behavior.
- **The Add clause or clauses specify the name and location of the journal file and the backup file generated by automatic backup operations as follows:**
 - **Add [Journal] journal-name**

Specifies the name for the after-image journal file described in the Journal clause. The journal-name is the name of the journal object. A journal object is the journal file specification plus all the attributes (allocation, extent, and so on) given to it in the journal clause.
 - **! File file-specification**

Provides the full file specification and version number of the .aij file named in the Add clause. This line of output is provided because the next line (File filename) provides the string that the user entered when he or she created the .aij file. For example, if the user entered a file name only, and this line of output was not provided, you would have to issue the RMU Dump command to determine in which directory the file resides.
 - **File filename**

Specifies the file name for the .aij file being added. This option is required.
 - **Allocation Is n**

Specifies the size of the .aij file (in blocks). If this option is omitted, the default allocation size is 512 blocks.

See the *Oracle Rdb Guide to Database Maintenance* for guidance on setting the allocation size.

RMU Show After_Journal Command

- Backup_File filename
Specifies the backup file name for automatic backup operations. Note that it is not valid to specify a Backup_File clause in the Add clause if you have specified Backups Are Manual in the Journal clause; Oracle RMU returns an error if you attempt to do so.
- Edit String Is (edit-string-options)
Specifies an edit string to apply to the backup file when the .aij is backed up automatically. See the description of the Edit_Filename keyword in Section 1.50 for a description of the available keywords.

Command Parameters

root-file-spec

The root file specification of the database for which you want the after-image journal configuration to be displayed.

Command Qualifiers

Backup_Context

Nobackup_Context

The Backup_Context qualifier specifies that the following symbols be initialized, unless you have issued a DCL SET SYMBOL/SCOPE=(NOLOCAL, NOGLOBAL) command:

- RDM\$AIJ_SEQNO
Contains the sequence number of the last .aij backup file written to tape. This symbol has a value identical to RDM\$AIJ_BACKUP_SEQNO. RDM\$AIJ_SEQNO was created prior to Oracle Rdb Version 6.0 and is maintained for compatibility with previous versions of Oracle Rdb.
- RDM\$AIJ_CURRENT_SEQNO
Contains the sequence number of the currently active .aij file. A value of -1 indicates that after-image journaling is disabled.
- RDM\$AIJ_NEXT_SEQNO
Contains the sequence number of the next .aij file that needs to be backed up. This symbol always contains a positive integer value (which may be 0).
- RDM\$AIJ_LAST_SEQNO
Contains the sequence number of the last .aij file available for a backup operation, which is different from the current sequence number if fixed-size journaling is being used. A value of -1 indicates that no journal has ever been backed up.

RMU Show After_Journal Command

If the value of the RDM\$AIJ_NEXT_SEQNO symbol is greater than the value of the RDM\$AIJ_LAST_SEQNO symbol, then no more .aij files are currently available for the backup operation.

- **RDM\$AIJ_BACKUP_SEQNO**
Contains the sequence number of the last .aij file backed up (completed) by the backup operation. This symbol is set at the completion of an .aij backup operation. A value of -1 indicates that this process has not yet backed up an .aij file.
- **RDM\$AIJ_COUNT**
Contains the number of available .aij files.
- **RDM\$AIJ_ENDOFFILE**
Contains the end of file block number for the current AIJ journal.
- **RDM\$AIJ_FULLNESS**
Contains the percent fullness of the current AIJ journal.

The Nobackup_Context qualifier specifies that the preceding symbols will not be initialized.

The Nobackup_Context qualifier is the default.

Note that these are string symbols, not integer symbols, even though their equivalence values are numbers. Therefore performing arithmetic operations with them produces unexpected results.

If you need to perform arithmetic operations with these symbols, first convert the string symbol values to numeric symbol values using the OpenVMS F\$INTEGER lexical function. For example:

```
$ SEQNO_RANGE = F$INTEGER(RDB$AIJ_LAST_SEQNO) - F$INTEGER(RDB$AIJ_NEXT_SEQNO)
```

Output[=file-name]

Specifies the name of the file where output is sent. The default is SYS\$OUTPUT. The default output file extension is .lis, if you specify only a file name.

RMU Show After_Journal Command

Usage Notes

- To use the RMU Show After_Journal command for a database, you must have the RMU\$BACKUP, RMU\$RESTORE, or RMU\$VERIFY privilege in the root file access control list (ACL) for the database or the OpenVMS SYSPRV or OpenVMS BYPASS privilege.

Examples

Example 1

The following example shows the output from the RMU Show After_Journal command when one journal is available, which means extensible journaling will be used. The commented line is generated by the RMU Show After_Journal command to display the full file specification for the added .aij file. The next line shows the actual file specification entered by the user when he or she created the .aij file configuration. In this example, the user did not enter a full specification, therefore only the file name appears in the uncommented portion of the code.

```
$ RMU/SHOW AFTER_JOURNAL MF_PERSONNEL
JOURNAL IS ENABLED -
  RESERVE 1 -
  ALLOCATION IS 512 -
  EXTENT IS 512 -
  OVERWRITE IS DISABLED -
  SHUTDOWN_TIMEOUT IS 60 -
  NOTIFY IS DISABLED -
  BACKUPS ARE MANUAL -
  CACHE IS DISABLED
ADD JOURNAL AIJ_ONE -
! FILE USER2:[JOURNALONE]AIJ1.AIJ;1
  FILE AIJ1.AIJ -
  BACKUP DISK1:[BACKUP_AIJ]AIJ1BCK.AIJ; -
  EDIT_STRING IS (SEQUENCE)
  ALLOCATION IS 512
```

Example 2

The following example shows the output from the RMU Show After_Journal command when two journal files are enabled, which means fixed-size journaling will be used. In this example, the user entered a full file specification for the .aij file when the .aij file configuration was created. Thus, the commented line and the one appearing below it are identical with the exception of the file version:

RMU Show After_Journal Command

```
$ RMU/SHOW AFTER_JOURNAL MF_PERSONNEL

JOURNAL IS ENABLED -
  RESERVE 2 -
  ALLOCATION IS 512 -
  EXTENT IS 512 -
  OVERWRITE IS DISABLED -
  SHUTDOWN_TIMEOUT IS 60 -
  NOTIFY IS DISABLED -
  BACKUPS ARE MANUAL -
  CACHE IS DISABLED
ADD JOURNAL AIJ_ONE.AIJ -
! FILE DISK2:[AIJ]AIJ1.AIJ;1
  FILE DISK2:[AIJ]AIJ1.AIJ -
  BACKUP DISK1:[BACKUP_AIJ]AIJ1BCK.AIJ; -
  EDIT_STRING IS (SEQUENCE)
  ALLOCATION IS 512
ADD JOURNAL AIJ_TWO.AIJ -
! FILE DISK3:[AIJTWO]AIJ2.AIJ;1
  FILE DISK3:[AIJTWO]AIJ2.AIJ -
  BACKUP DISK1:[BACKUP_AIJ]AIJ2BCK.AIJ; -
  EDIT_STRING IS (SEQUENCE)
  ALLOCATION IS 512
```

Example 3

The following example uses the RMU Show After_Journal command to show the settings of the symbolic names for the .aij sequence numbers before and after the RMU Backup command is executed:

```
$ RMU/SHOW AFTER_JOURNAL/BACKUP_CONTEXT MF_PERSONNEL

JOURNAL IS ENABLED -
  RESERVE 4 -
  ALLOCATION IS 512 -
  EXTENT IS 512 -
  OVERWRITE IS DISABLED -
  SHUTDOWN_TIMEOUT IS 60 -
  NOTIFY IS DISABLED -
  BACKUPS ARE MANUAL -
  CACHE IS DISABLED
ADD JOURNAL AIJ2 -
! FILE DISK2:[DB]AIJ_TWO;1
  FILE DISK2:[DB]AIJ_TWO -
  ALLOCATION IS 512
ADD JOURNAL AIJ3 -
! FILE DISK3:[DB]AIJ_THREE;1
  FILE DISK3:[DB]AIJ_THREE -
  ALLOCATION IS 512
```

RMU Show After_Journal Command

```
$ SHOW SYMBOL RDM$AIJ*
RDM$AIJ_COUNT == "2"
RDM$AIJ_CURRENT_SEQNO == "0"
RDM$AIJ_ENDOFFILE == "1"
RDM$AIJ_FULLNESS == "0"
RDM$AIJ_LAST_SEQNO = "-1"
RDM$AIJ_NEXT_SEQNO = "0"
$ RMU/BACKUP/AFTER MF_PERSONNEL AIJ_TWO, AIJ_THREE

%RMU-I-LOGBCKAIJ, backing up after-image journal RDM$JOURNAL
%RMU-I-AIJBCKSEQ, backing up current after-image journal sequence
number 0
$ RMU/SHOW AFTER_JOURNAL/BACKUP_CONTEXT MF_PERSONNEL
.
.
.

$ SHOW SYMBOL RDM$AIJ*
RDM$AIJ_BACKUP_SEQNO == "-1"
RDM$AIJ_COUNT == "2"
RDM$AIJ_CURRENT_SEQNO = "1"
RDM$AIJ_ENDOFFILE == "1"
RDM$AIJ_FULLNESS == "0"
RDM$AIJ_LAST_SEQNO = "0"
RDM$AIJ_NEXT_SEQNO = "1"
RDM$AIJ_SEQNO == "-1"
```

RMU Show Audit Command

1.61.2 RMU Show Audit Command

Displays the set of security auditing characteristics established by the RMU Set command with Audit qualifier.

Format

RMU/Show Audit root-file-spec

Command Qualifiers

/All
/Daccess[=object-type[,...]]
/Every
/Flush
/Identifiers
/Output[=file-name]
/Protection
/Rmu
/Type={Alarm|Audit}

Defaults

See description
See description
See description
See description
See description
/Output=SYS\$OUTPUT
See description
See description
Alarm and Audit

Description

The RMU Show Audit command is the Oracle Rdb equivalent to the DCL SHOW AUDIT command. Because Oracle Rdb security auditing uses many OpenVMS system-level auditing mechanisms, certain auditing characteristics such as /FAILURE_MODE can only be displayed using the OpenVMS SHOW AUDIT command, which requires the OpenVMS SECURITY privilege.

Command Parameters

root-file-spec

The root file specification of the database for which you want auditing information to be displayed.

Command Qualifiers

All

Displays all available auditing information for the database, including the following: whether security auditing and security alarms are started or stopped; types of security events currently enabled for alarms and audits; identifiers currently enabled for auditing; and whether forced write operations are enabled or disabled.

RMU Show Audit Command

Daccess[=object-type[, . . .]]

Indicates whether the general DACCESS audit event class is currently enabled. Specifying one or more object types with the Daccess qualifier displays the object types and their associated privileges that are currently enabled for DACCESS event auditing. If you specify more than one object type, enclose the list of object types within parentheses.

The valid object types are:

- DATABASE
- TABLE
- COLUMN

Every

Displays the current setting for the first or every DACCESS event auditing for the database.

Flush

Displays the current setting for forced write operations on audit journal records for the database.

Identifiers

Displays the user identification codes (UICs) of the users currently enabled for DACCESS event auditing of specified objects.

Output[=file-name]

Controls where the output of the command is sent. If you do not enter the Output qualifier, or if you enter the Output qualifier without a file specification, the output is sent to the current process default output stream or device.

Protection

Displays whether auditing is currently enabled for the PROTECTION audit event class.

Rmu

Displays whether auditing is currently enabled for the RMU event class.

Type={Alarm | Audit}

Displays information about security alarms or security auditing. If you do not specify the Type qualifier, Oracle RMU displays information about both security alarms and security auditing.

RMU Show Audit Command

Usage Notes

- To use the RMU Show Audit command for a database, you must have the RMU\$SECURITY privilege in the root file ACL for the database or the OpenVMS SECURITY or BYPASS privilege.
- If you do not specify any qualifiers with the RMU Show Audit command, the currently enabled alarm and audit security events are displayed.
- Use the RMU Show Audit command to check which auditing features are enabled whenever you plan to enable or disable audit characteristics with a subsequent RMU Set Audit command.
- When the RMU Show Audit command is issued for a closed database, the command executes without other users being able to attach to the database.

Examples

Example 1

The following command shows that alarms are enabled for the RMU and PROTECTION audit classes for the mf_personnel database. Note that the display shows that alarms are also enabled for the AUDIT audit class. The AUDIT audit class is always enabled and cannot be disabled.

```
$ RMU/SHOW AUDIT/ALL MF_PERSONNEL
Security auditing STOPPED for:
  PROTECTION (disabled)
  RMU (disabled)
  AUDIT (enabled)
  ACCESS (disabled)

Security alarms STOPPED for:
  PROTECTION (enabled)
  RMU (enabled)
  AUDIT (enabled)
  ACCESS (disabled)

Audit flush is disabled

Audit every access

Enabled identifiers:
  None
```

RMU Show Audit Command

Example 2

In the following example, the first command enables and starts alarms for the RMU audit class for the mf_personnel database. Following the first command is the alarm that is displayed on a security terminal when the first command is executed. The second command displays the auditing characteristics that have been enabled and started. The RMU Show Audit command with the All qualifier causes the alarm at the end of the example to be displayed on the security terminal. Note that security-enabled terminals only receive alarms if alarms have been both enabled *and* started.

```
$ RMU/SET AUDIT/TYPE=ALARM/ENABLE=RMU/START MF_PERSONNEL
%%%%%%%%%%%%%%%%%%%%%%%%%%%%%%%% OPCOM  8-JUL-1996 09:41:01.19  %%%%%%%%%%%%%%%%%%%%%%%%%%%%%%%%%
Message from user RICK on MYNODE
Oracle Rdb Security alarm (SECURITY) on MYNODE, system id:      32327
Database name:          DDV21:[RICK.SQL]MF_PERSONNEL.RDB;1
Auditable event:       Auditing change
PID:                   21212274
Event time:            8-JUL-1996 09:41:01.17
User name:             RICK
RMU command:           RMU/SET AUDIT/TYPE=ALARM/ENABLE=RMU/START MF_PERSONNEL
Sub status:            RMU required privilege
Final status:          %SYSTEM-S-NORMAL
RMU privilege used:    RMU$SECURITY

$ RMU/SHOW AUDIT/ALL MF_PERSONNEL
Security auditing STOPPED for:
  PROTECTION (disabled)
  RMU (disabled)
  AUDIT (enabled)
  ACCESS (disabled)

Security alarms STARTED for:
  PROTECTION (disabled)
  RMU (enabled)
  AUDIT (enabled)
  ACCESS (disabled)

Audit flush is disabled

Audit every access

Enabled identifiers:
  None
```

RMU Show Audit Command

```

##### OPCOM 8-JUL-1996 09:43:07.94 #####
Message from user RICK on MYNODE
Oracle Rdb Security alarm (SECURITY) on MYNODE, system id: 32327
Database name: DDV21:[RICK.SQL]MF_PERSONNEL.RDB;1
Auditable event: Attempted RMU command
PID: 21212274
Event time: 8-JUL-1996 09:43:07.92
User name: RICK
RMU command: RMU/SHOW AUDIT/ALL MF_PERSONNEL
Access requested: RMU$SECURITY
Sub status: RMU required privilege
Final status: %SYSTEM-S-NORMAL
RMU privilege used: RMU$SECURITY

```

RMU Show Corrupt_Pages Command

1.61.3 RMU Show Corrupt_Pages Command

Indicates which pages, storage areas, or snapshot files are corrupt or inconsistent by displaying the contents of the corrupt page table (CPT). Corrupt pages are logged to the CPT, which is maintained in the database root file.

Format

RMU/Show Corrupt_Pages root-file-spec

Command Qualifiers

/Options={({Normal|Debug|Full})
/Output[=file-name]

Defaults

/Options=(Normal)
/Output=SYS\$OUTPUT

Command Parameters

root-file-spec

The root file specification of the database for which you want the corrupt or inconsistent storage areas or snapshot files logged to the CPT to be displayed.

Command Qualifiers

Options={({Normal or Full or Debug})

Specifies the type of information you want displayed, as follows:

- Normal
Displays the active CPT entries and the corrupt or inconsistent areas sorted by area and page.
- Full
Displays the same information as Normal plus the disks on which the active CPT entries and the corrupt or inconsistent areas or snapshot files are stored—sorted by disk, area, and page.
- Debug
Provides a dump of the entire CPT and lists all the storage areas.

Options=(Normal) is the default qualifier.

Output[=file-name]

Specifies the name of the file where output is sent. The default is SYS\$OUTPUT. The default output file extension is .lis, if you specify only a file name.

RMU Show Corrupt_Pages Command

Usage Notes

- To use the RMU Show Corrupt_Pages command for a database, you must have the RMU\$BACKUP, RMU\$RESTORE, or RMU\$VERIFY privilege in the root file access control list (ACL) for the database or the OpenVMS SYSPRV or OpenVMS BYPASS privilege.
- You can repair and remove a corrupt snapshot file from the CPT by issuing the RMU Repair command with the Initialize=(Snapshots) qualifier. Using the Repair command in this case is faster than performing a restore operation. See Section 1.40 for details.

Examples

Example 1

The following example shows the output from the RMU Show Corrupt_Pages command when page 1 in area 3 is marked as corrupt:

```
$ RMU/SHOW CORRUPT_PAGES MF_PERSONNEL
*-----*
* Oracle Rdb V7.0-00                               8-JUL-1996 13:46:20.77
*
* Dump of Corrupt Page Table
*   Database: USER1:[DB]MF_PERSONNEL.RDB;1
*
*-----*

Entries for storage area EMPIDS_MID
-----

    Page 1
      - AIJ recovery sequence number is -1
      - Area ID number is 3
      - Consistency transaction sequence number is 0:0
      - State of page is: corrupt

*-----*
* Oracle Rdb V7.0-00                               8-JUL-1996 13:46:21.17
*
* Dump of Storage Area State Information
*   Database: USER1:[DB]MF_PERSONNEL.RDB;1
*
*-----*

All storage areas are consistent.
```

RMU Show Locks Command

1.61.4 RMU Show Locks Command

Displays current information about the OpenVMS locks database on your node. It provides information concerning lock activity and contention for all active databases.

Format

RMU/Show Locks

Command Qualifiers

/Lock = lock-list
/Mode = (mode-list)
/Options = (option-list)
/Output[=file-name]
/Process = process-list
/Resource-type=resource-type-list

Defaults

None
None
See description
/Output=SYS\$OUTPUT
None
None

Description

In a clustered environment, the RMU Show Locks command displays detailed lock information for your current node and may display information about known remote locks.

The RMU Show Locks command displays information about process locks for all active databases on a specific node. A process requesting a lock can have one of three states: owning, blocking, or waiting. A process is considered to be owning when the lock request is granted. A process is considered to be blocking when the lock request is granted and its mode is incompatible with other waiting locks. A process is considered to be waiting when it is prevented from being granted a lock due to the presence of other granted locks whose modes are incompatible with the process' requested mode.

The values for the Mode qualifier: Blocking and Waiting, can be combined with the Process and Lock qualifiers to indicate which of the following types of information is displayed:

- If the Blocking option is specified, information is displayed about processes whose locks are blocking other processes' locks.
- If the Waiting option is specified, information is displayed about processes whose locks are waiting for other processes' locks.

RMU Show Locks Command

- If the Process qualifier is specified, information is displayed for a specified list of processes.
- If the Lock qualifier is specified, information is displayed for a specified list of locks. When no qualifiers are specified, a list of all active locks in the OpenVMS locks database is displayed.

Use the qualifiers individually or in combination to display the required output. See Table 1–16 for all possible qualifier combinations and the types of output they produce. If you do not specify any qualifiers, a complete list of locks is displayed. The volume of information from this report can be quite large. Therefore, you should use the Output qualifier to direct output to a file, instead of allowing the output to display to SYS\$OUTPUT. Each output contains a heading that indicates what qualifiers, if any, were used to generate the output.

Table 1–16 Lock Qualifier Combinations

Object	Mode Argument	Option Argument	Output
Process			Locks for the specified processes
Process	Blocking		Processes blocking the specified processes
Process	Waiting		Processes waiting for the specified processes
Process		All	Process locks for the specified processes
Process		Full	Special process locks for the specified processes
Process	Blocking, Waiting		Processes blocking and waiting for the specified processes
Process	Blocking	Full	Special process locks blocking the specified processes
Process	Waiting	Full	Special process locks waiting for the specified processes
Process	Blocking, Waiting	Full	Special process locks blocking and waiting for the specified processes
Process		All, Full	Process and special process locks for the specified processes

(continued on next page)

RMU Show Locks Command

Table 1–16 (Cont.) Lock Qualifier Combinations

Object	Mode Argument	Option Argument	Output
Lock			Locks for the specified locks
Lock	Blocking		Processes blocking the specified locks
Lock	Waiting		Processes waiting for the specified locks
Lock		Full	Special process locks for the specified locks
Lock	Blocking	Full	Special process locks blocking the specified locks
Lock	Waiting	Full	Special process locks waiting for the specified locks
Lock	Blocking, Waiting		Processes blocking and waiting for the specified locks
Lock	Blocking, Waiting	Full	Special process locks blocking and waiting for the specified locks
	Blocking		Lock requests that are blocked
	Waiting		Lock requests that are waiting
	Blocking, Waiting		Lock requests that are blocking and waiting
Process Lock			Locks for specified processes and locks
Process Lock	Blocking		Processes blocking the specified processes and locks
Process Lock	Waiting		Processes waiting for the specified processes and locks
Process Lock	Blocking, Waiting		Processes blocking and waiting for the specified processes and locks
Process Lock	Blocking	Full	Special process locks blocking the specified processes and locks
Process Lock	Waiting	Full	Special process locks waiting for the specified processes and locks
Process Lock		All	Process locks for the specified processes and locks

(continued on next page)

RMU Show Locks Command

Table 1–16 (Cont.) Lock Qualifier Combinations

Object	Mode Argument	Option Argument	Output
Process Lock		Full	Special process locks for the specified processes and locks
Process Lock	Blocking	Full	Special process locks blocking the specified processes and locks
Process Lock		All, Full	Process and special process locks for the specified processes and locks

You can display only those processes that you have privilege to access. Furthermore, certain *special* database processes are not displayed, unless you specifically indicate that all processes are to be displayed. The report heading indicates what qualifiers were used to generate the output.

Command Qualifiers

Lock=lock-list

Displays information for each of the specified locks. When combined with the Mode=Blocking qualifier, the Lock qualifier displays information about processes whose locks are blocking the specified locks. When combined with the Mode=Waiting qualifier, the Lock qualifier displays information about processes whose lock requests are waiting for the specified locks.

One or more locks can be specified; if more than one lock is specified, they must be enclosed in parentheses and separated by commas. The lock identifier is an 8-digit hexadecimal number, and must be local to the node on which the RMU Show Locks command is issued. To see the lock identifier upon which a process is waiting, you can do either of the following:

- Invoke the character cell Performance Monitor “Stall Messages” display.
- Invoke the Performance Monitor from your PC and select Displays ⇒ Process Statistics ⇒ Stall Messages.

Mode=(mode-list)

Indicates the lock mode to be displayed. If you specify more than one option in the mode-list, you must separate the options with a comma, and enclose the mode-list in parentheses. The following lock mode options are available:

RMU Show Locks Command

- **Blocking**

Displays the set of processes whose locks are blocking the lock requests of other processes. A process is considered to be waiting when it has requested a lock mode that is incompatible with existing granted lock modes; in this case, the requestor is the waiting process and the grantors are the blocking processes.

The first line of output identifies a process that is waiting for a lock request to be granted. All subsequent lines of output identify those processes that are preventing the lock request from being granted. When multiple processes are waiting for the same lock resource, multiple sets of process-specific information, one for each waiting process, are displayed.
- **Culprit**

Displays the set of locks for processes that are blocking other processes but are themselves not locked. The output represents the processes that are the source of database stalls and performance degradation.
- **Waiting**

Displays the set of processes whose lock requests are waiting due to incompatible granted locks for other processes. A process is considered to be blocking others when it has been granted a lock mode that is incompatible with requested lock modes; in this case, the “Blocker” is the blocking process and the “Waiting” are the waiting processes.

A requesting process can appear to be waiting for other lock requestors. This condition occurs when there are many processes waiting on the same lock resource. Depending upon the sequence of processes in the wait queue, certain waiting processes appear to be blocking other waiting processes because, eventually, they will be granted the lock first.

The first line of output identifies a process that has been granted a lock on a resource. All subsequent lines of output identify those processes that are waiting for lock requests on the same resource to be granted. When multiple processes are blocking the same lock resource, multiple sets of process-specific information, one for each blocking process, are displayed.

Options=(option-list)

Indicates the type of information and the level of detail the output will include. If you do not specify the Options qualifier, the default output is displayed. If you specify more than one type of output for the Options qualifier, you must separate the options with a comma, and enclose the options list within parentheses. The following options are available:

RMU Show Locks Command

- All

Used when you want the complete list of process locks; by default, lock information for only the specified process is displayed. When you specify the All option, information is displayed for all other processes that have a need to know the lock held by the specific process. This method is an easy way to display all of a process' locks and to see what other processes are also using the same resource.

If the Mode qualifier is specified, the Options=(All) qualifier is ignored.

- Full

Indicates that special database processes are to be displayed. Some special database processes, such as monitors, perform work on behalf of a database. These database processes frequently request locks that by design conflict with other processes' locks; the granting of these locks indicates an important database event.

By default, these special database processes are not displayed because they increase the size of the output.

Output[=file-name]

Specifies the name of the file where output is sent. The default is SYS\$OUTPUT. The default output file extension is .lis, if you specify only a file name.

Process=process-list

Displays information for each lock held or requested by the specified processes when used by itself. When the Process qualifier is combined with the Mode=Blocking qualifier, information is displayed about processes whose locks are blocking lock requests by the specified waiting processes.

Note

When the Process qualifier is specified without any Options qualifier values, all locks for the processes are displayed, including owning, blocking, and waiting locks.

One or more processes can be specified; if more than one process is specified, they must be enclosed within parentheses and separated by commas. The process identifier is an 8-digit hexadecimal number, and must be local to the node on which the RMU Show Locks command is issued. The process ID must include all eight characters; the node identifier portion of the process ID cannot be excluded. To get more information, use the Options=All qualifier to display all users using processes' locks.

RMU Show Locks Command

Resource_type=resource-type-list

Displays information for each lock held or requested by the specified resource type. Only the specific resource types will be displayed. This permits, for example, only PAGE or RECORD lock types to be selected.

One or more resource types can be specified; if more than one type is specified, they must be enclosed within parentheses and separated by commas.

The following keywords are allowed with the Resource_type qualifier.

Table 1–17 RESOURCE_TYPE Keywords

Internal Lock Type Name	Keyword(s)
ACCESS	ACCESS
ACTIVE	ACTIVE
AIJDB	AIJDB
AIJFB	AIJFB
AIJHWM	AIJHWM, AIJ_HIGH_WATER_MARK
AIJLOGMSG	AIJ_LOG_MESSAGE
AIJLOGSHIP	AIJ_LOG_SHIPPING
AIJOPEN	AIJ_OPEN
AIJSWITCH	AIJ_SWITCH
AIJ	AIJ
AIPQHD	AIP
ALS	ALS_ACTIVATION
BCKAIJ	AIJ_BACKUP, BCKAIJ
BCKAIJ_SPD	AIJ_BACKUP_SUSPEND
BUGCHK	BUGCHECK
CHAN	CHAN, FILE_CHANNEL
CLIENT	CLIENT
CLOSE	CLOSE
CLTSEQ	CLTSEQ
CPT	CORRUPT_PAGE_TABLE, CPT
DASHBOARD	DASHBOARD_NOTIFY

(continued on next page)

RMU Show Locks Command

Table 1–17 (Cont.) RESOURCE_TYPE Keywords

Internal Lock Type Name	Keyword(s)
DBK_SCOPE	DBKEY_SCOPE
DBR	DBR_SERIALIZATION
DB	DATABASE
FIB	FAST_INCREMENTAL_BACKUP, FIB
FILID	FILID
FRZ	FREEZE
GBL_CKPT	GLOBAL_CHECKPOINT
GBPT_SLOT	GLOBAL_BPT_SLOT
KROOT	KROOT
LAREA	LAREA, LOGICAL_AREA
LOGFIL	LOGFIL
MEMBIT	MEMBIT
MONID	MONID, MONITOR_ID
MONITOR	MONITOR
NOWAIT	NOWAIT
PLN	DBKEY, RECORD, PLN
PNO	PAGE, PNO
QUIET	QUIET
RCACHE	RCACHE
RCSREQUEST	RCS_REQUEST
RCSWAITRQST	RCS_WAIT_REQUEST
REL_AREAS	RELEASE_AREAS
REL_GRIC_REQST	RELEASE_GRIC_REQUEST
RMUCLIENT	RMU_CLIENT
ROOT_AREA	DUMMY_ROOT_AREA
RO_L1	L1_SNAP_TRUNCATION
RTUPB	RTUPB
RUJBLK	RUJBLK

(continued on next page)

RMU Show Locks Command

Table 1–17 (Cont.) RESOURCE_TYPE Keywords

Internal Lock Type Name	Keyword(s)
RW_L2	L2_SNAP_TRUNCATION
SAC	SNAP_AREA_CURSOR
SEQBLK	SEQBLK
STAREA	STORAGE_AREA, PAREA
STATRQST	STATISTICS_REQUEST
TRM	TERMINATION
TSNBLK	TSNBLK
UTILITY	UTILITY

The RESOURCE_TYPE qualifier is incompatible with the MODE, LIMIT, LOCK and PROCESS qualifiers.

Usage Notes

- To use the RMU Show Locks command for a database, you must have the OpenVMS WORLD privilege.
- When you specify a list of processes or lock identifiers, make sure the processes or locks are local to the node on which the RMU Show Locks command is issued.
- To display the complete list of locks in the OpenVMS locks database, do not specify the Mode=Blocking or Waiting qualifier. The volume of information from this report can be quite large.
- If you have entered an Oracle RMU command and there are no locks on your node, you receive the following message:

```
%RMU-I-NOLOCKSOUT, No locks on this node with the specified  
qualifiers.
```
- When you use the RMU Show Locks command to display locks, the “requested” and “granted” modes of the given lock are displayed. The definitions for the two fields follow:
 - Requested

RMU Show Locks Command

This is the mode for which the process has requested the lock. Valid modes are NL, CR, CW, PR, PW, and EX. This mode is not guaranteed to be granted; some locks are intentionally held in conflicting modes forever (for example, the “termination” lock).

– **Granted**

This is the mode that the process was last granted for the lock. Valid modes are NL, CR, CW, PR, PW, and EX. Furthermore, if the lock has never been previously granted, the lock mode is displayed as NL mode.

Table 1–18 shows the compatibility of requested and granted lock modes.

Table 1–18 Lock Mode Compatibility

Mode of Requested Lock	Mode of Currently Granted Locks					
	NL	CR	CW	PR	PW	EX
NL	Yes	Yes	Yes	Yes	Yes	Yes
CR	Yes	Yes	Yes	Yes	Yes	No
CW	Yes	Yes	Yes	No	No	No
PR	Yes	Yes	No	Yes	No	No
PW	Yes	Yes	No	No	No	No
EX	Yes	No	No	No	No	No

Key to Lock Modes

NL—Null Lock
CR—Concurrent Read
CW—Concurrent Write
PR—Protected Read
PW—Protected Write
EX—Exclusive Lock
Yes—Locks compatible
No—Locks not compatible

- If the “requested” and “granted” lock modes differ, then the lock requested is currently blocked on either the “wait” or “conversion” queue. If the modes are the same, then the lock has been granted.
- The OpenVMS distributed lock manager does not always update the requested lock mode. This means that potentially conflicting information can be displayed by the RMU Show Locks utility.

RMU Show Locks Command

- The requested lock mode is updated only under the following situations:
 - The lock request is for a remote resource.
 - The lock request is a Nowait request.
 - The lock request could not be granted due to a lock conflict (that is, it was canceled by the application or aborted due to lock timeout or deadlock).
 - The lock request is the first for the resource.
- Consider the following RMU Show Locks output:

```

-----
Resource Name: page 533
Granted Lock Count: 1, Parent Lock ID: 01000B6C, Lock Access Mode:
Executive,
Resource Type:
    Global, Lock Value Block: 03000000 00000000 00000000 00000002
    -Master Node Info-  --Lock Mode Information--  -Remote Node Info-
ProcessID Lock ID SystemID Requested Granted Queue Lock ID SystemID
2040021E 0400136A 00010002 EX CR GRANT 0400136A 00010002
-----

```

In this example, it is ordinarily difficult to explain how such a combination of lock modes could occur. Note that the CR (concurrent read) mode is on the Grant queue (not the Conversion queue).

Knowledge of the operating environment is necessary to know that there was only one node on this system. It turns out that two lock requests actually occurred to generate this output, in the *opposite* order of what appears to have occurred.

The first lock request was for EX (exclusive), which was immediately granted. Thus, the Requested and Granted modes were updated according to situation 4. Then, the lock was demoted from EX to CR mode, which was also immediately granted. However, the Requested field was *not* updated because none of the four preceding rules was true, so the Requested mode was never updated to reflect the CR lock request.

- Additional field definitions for the command output are as follows:
 - Conversion Lock Count:

This is the total number of locks that are currently on the conversion queue of the resource associated with the lock. The conversion queue is a queue containing locks that have been granted but are in the process of being converted to a new, conflicting lock mode. Note that the total

RMU Show Locks Command

number of granted locks on the resource is equal to the sum of the granted and conversion queues.

- **Granted Lock Count:**

This is the total number of locks that are currently in the granted queue of the resource associated with the lock. Note that the total number of granted locks on the resource is equal to the sum of the locks in the granted and conversion queues.

- **Lock Access Mode:**

This is the access mode associated with the first lock request on the indicated resource name. Possible resource names are Kernel = 0, Executive = 1, Supervisor = 2, User = 3.

- **Lock ID**

This is the lock identifier for the indicated process on the indicated resource name. Each process lock request on a resource results in a unique lock identifier being issued.

- **Lock Value Block:**

This field displays the contents of the lock value block associated with the indicated resource.

- **Number of Sub-Resources:**

This is the number of subresources of the indicated resource name. Note, however, that the number of subresources may differ from the number of child locks of the lock because any number of processes may lock the resource. If any of these processes then locks another resource, and in doing so creates the lock as a child of the other lock, then the second resource becomes a subresource of the first resource.

- **Parent Lock Count:**

This is the number of locks that have this lock as a parent.

- **Parent Lock ID:**

This is the lock identifier of the parent lock of the indicated lock.

- **Process Group:**

This is the user identification code (UIC) group number of the process that took out the first lock on the indicated process, thereby creating the resource.

- **ProcessID**

This is the process identifier of the process that owns the lock.

RMU Show Locks Command

- Process Name
This is the name of the process that owns the lock.
- Queue
This field identifies the queue on which the lock request has been placed. Valid queues include Grant, Conversion, and Waiting. The Grant queue means the lock has been granted and is not in the process of being converted to another lock mode. The Conversion queue means the lock has been granted but is in the process of being converted to a new, conflicting lock mode. The Waiting queue means the lock request is new and conflicts with a granted or converting lock.
- Requested
This is the mode for which the process requested the lock. Valid modes are NL (null), PR (protected read), PW (protected write), CR (concurrent read), CW (concurrent write), and EX (exclusive).
- Resource:
That which is being locked.
- Resource Name:
This is the name of the Oracle Rdb or Oracle CODASYL DBMS resource. Optionally included in the resource name is additional information, such as page and line numbers.
- Resource Type:
This field indicates if the lock is global or local.
- System ID
This is the cluster system identification of the node currently overseeing the resource associated with the indicated lock for the indicated process.

Examples

Example 1

The following example shows a portion of the output generated by the command, RMU Show Locks command with the Process=44A047C9 qualifier. The actual report is several pages in length because it shows *all* the locks held by process ID 44A047C9. The report text shows the resource on which the lock is held, ID information, and lock status (Requested and Granted).

RMU Show Locks Command

```
$ RMU/SHOW LOCKS/PROCESS=44A047C9
=====
SHOW LOCKS/PROCESS Information
=====
.
.
.
-----
Resource: page 352
      ProcessID Process Name      Lock ID  System ID Requested  Granted
      -----
Owner:  44A047C9  USER1.....  7CC80BC8  00020025  PR           PR
-----
Resource: cluster membership
      ProcessID Process Name      Lock ID  System ID Requested  Granted
      -----
Owner:  44A047C9  USER1.....  16180C1A  00020025  PR           PR
.
.
.
-----
Resource: logical area 39
      ProcessID Process Name      Lock ID  System ID Requested  Granted
      -----
Owner:  44A047C9  USER1.....  45983EC0  00020025  EX           EX
.
.
.
-----
Resource: logical area 33
      ProcessID Process Name      Lock ID  System ID Requested  Granted
      -----
Owner:  44A047C9  USER1.....  0480973C  00020025  CR           NL
-----
Resource: logical area 53
      ProcessID Process Name      Lock ID  System ID Requested  Granted
      -----
Owner:  44A047C9  USER1.....  56009774  00020025  EX           EX
.
.
.
```

Example 2

RMU Show Locks Command

The following display shows the output generated by the RMU Show Locks command with the Process=44A047C9 and the Mode=Waiting qualifiers. The report shows that process ID 44A045D1 is waiting for the exclusive (EX) lock held by the specified process (44A047C9) on logical area 39 to be released.

```
$ RMU/SHOW LOCKS/PROCESS=44A047C9/MODE=WAITING
=====
SHOW LOCKS/PROCESS/WAITING Information
=====
-----
Resource: logical area 39
      ProcessID Process Name      Lock ID   System ID Requested  Granted
      -----
Blocker: 44A047C9  USER1.....  45983EC0 00020025  EX           EX
Waiting: 44A045D1  _RTA11:..... 3B5467DA 00020025  CR           NL
```

This command identifies the waiting process. If you specify the ID of a process that is itself a waiting process, Oracle RMU returns the following message:

no locks on this node with the specified qualifiers.

Example 3

The following display shows the output generated by the RMU Show Locks command with the Process=44A045D1 and the Mode=Blocking qualifiers. The report shows that process ID 44A047C9 has an exclusive (EX) lock on logical area 39, and is blocking the specified process (44A045D1).

```
$ RMU/SHOW LOCKS/PROCESS=44A045D1/MODE=BLOCKING
=====
SHOW LOCKS/BLOCKING Information
=====
-----
Resource: logical area 39
      ProcessID Process Name      Lock ID   System ID Requested  Granted
      -----
Waiting: 44A045D1  _RTA11:..... 3B5467DA 00020025  CR           NL
Blocker: 44A047C9  USER1.....  45983EC0 00020025  EX           EX
```

This command identifies the blocking process. If you specify the ID of a process that is itself the blocking process, Oracle RMU returns the following message:

no locks on this node with the specified qualifiers.

Example 4

RMU Show Locks Command

The following display shows the output generated by the RMU Show Locks command with the Lock=45983EC0 and the Mode=Waiting qualifiers. The report is identical to the display shown in Example 2 because process ID 44A047C9 has taken out only one lock. If process ID 44A047C9 held multiple locks, Example 2 would display all of them, but this example would only display lock information for lock ID 45983EC0.

```
$ RMU/SHOW LOCKS/LOCK=45983EC0/MODE=WAITING MF_PERSONNEL
=====
SHOW LOCKS/LOCK/WAITING Information
=====
-----
Resource: logical area 39
-----
          ProcessID Process Name          Lock ID   System ID Requested  Granted
-----
Blocker:  44A047C9  USER1.....  45983EC0  00020025
Waiting:  44A045D1  _RTA11:..... 3B5467DA  00020025  CR      NL
```

Example 5

The following display shows a portion of the output generated by the RMU Show Locks command and the Process=44A047C9 and the Options=All qualifiers. The actual report is several pages in length because it lists all the resources that have locks held by process ID 44A047C9 and all the locks on the same resource held by other processes. Compare this report with the one shown in Example 1.

```
$ RMU/SHOW LOCKS/PROCESS=44A047C9/OPTIONS=ALL
=====
SHOW LOCKS/PROCESS Information
=====
-----
Resource: page 352
-----
          ProcessID Process Name          Lock ID   System ID Requested  Granted
-----
Owner:    44A047C9  USER1.....  7CC80BC8  00020025  PR      PR
Owner:    44A045D1  _RTA11:..... 134C0979  00020025  PR      CR
-----
Resource: cluster membership
-----
          ProcessID Process Name          Lock ID   System ID Requested  Granted
-----
Owner:    44A047C9  USER1.....  16180C1A  00020025  PR      PR
Owner:    44A045D1  _RTA11:..... 333C95ED  00020025  PR      PR
```

RMU Show Locks Command

```

.
.
-----
Resource: logical area 39
      ProcessID Process Name      Lock ID   System ID Requested Granted
-----
Owner:  44A047C9  USER1.....  45983EC0  00020025  EX       EX
Waiting: 44A045D1  _RTA11:..... 3B5467DA  00020025  CR       NL
.
.
-----
Resource: logical area 33
      ProcessID Process Name      Lock ID   System ID Requested Granted
-----
Owner:  44A047C9  USER1.....  0480973C  00020025  CR       NL
Owner:  44A045D1  _RTA11:..... 31900BAE  00020025  CR       CR
.
.
-----
Resource: logical area 53
      ProcessID Process Name      Lock ID   System ID Requested Granted
-----
Owner:  44A047C9  USER1.....  56009774  00020025  EX       EX
.
.

```

Example 6

The following display shows the output generated by the RMU Show Locks command with the Mode=(Waiting,Blocking) and the Process=(44A045D1,44A047C9) qualifiers. This command combines the output shown in Examples 3 and 4 into a single report.

```

$ RMU/SHOW LOCKS/MODE=(WAITING,BLOCKING)/PROCESS=(44A045D1,44A047C9)
=====
SHOW LOCKS/PROCESS/BLOCKING Information
=====
Resource: logical area 39
      ProcessID Process Name      Lock ID   System ID Requested Granted
-----
Waiting: 44A045D1  _RTA11:..... 3B5467DA  00020025  CR       NL
Blocker: 44A047C9  USER1.....  45983EC0  00020025  EX       EX
=====
SHOW LOCKS/PROCESS/WAITING Information
=====

```

RMU Show Locks Command

```
-----  
Resource: logical area 39  

|          | ProcessID | Process Name | Lock ID  | System ID | Requested | Granted |
|----------|-----------|--------------|----------|-----------|-----------|---------|
| Blocker: | 44A047C9  | USER1.....   | 45983EC0 | 00020025  | EX        | EX      |
| Waiting: | 44A045D1  | _RTA11:..... | 3B5467DA | 00020025  | CR        | NL      |

```

Example 7

When possible, the RMU Show Locks command formats the area number for page locks. When the area lock can be determined for the page lock, the area number is included in the output, as seen in the following example:

```
Resource Name: page 566 (area 1)  
Granted Lock Count: 4, Parent Lock ID: 7E00FAFC, Lock Access Mode: Executive,  
Resource Type: Global, Lock Value Block: 00000000 00000000 00000000 03000000
```

```
      -Master Node Info- --Lock Mode Information-- -Remote Node Info-  
ProcessID Lock ID  SystemID Requested Granted Queue Lock ID SystemID  
2504D32C  6400199C  00010028 CR          PR      GRANT 6400199C 00010028  
2504D32C  58002984  00010028 CR          PR      GRANT 58002984 00010028
```

RMU Show Logical_Names Command

1.61.5 RMU Show Logical_Names Command

Displays logical names known by various components of Oracle Rdb.

Format

RMU/Show Logical_Names [logical-name]

Command Qualifiers

/Output=file-name
/Undefined

Defaults

SY\$\$OUTPUT
None

Description

The RMU Show Logical_Names command displays the definitions of logical names known by various components of Oracle Rdb. You can specify all logical names or just one. The output format is similar to that of the DCL SHOW LOGICALS command.

Command Parameters

logical-name

Use this option to display the definition of one logical name. If you omit the logical name, the definitions of all logical names known to Oracle Rdb are displayed.

Command Qualifiers

Output=file-name

Specifies the name of the file where output is to be sent. The default is SY\$\$OUTPUT. The default output file type is .lis, if you specify a file name.

Undefined

Use the Undefined qualifier to display a list of both defined and undefined logicals.

RMU Show Logical_Names Command

Examples

Example 1

The following example displays defined logical names known to Oracle Rdb.

```
$ rmu/sho log
"RDM$BIND_ABS_LOG_FILE" = "ABS_PID.OUT" (LNM$SYSTEM_TABLE)
"RDM$BIND_ALS_OUTPUT_FILE" = "ALS_PID.OUT" (LNM$SYSTEM_TABLE)
"RDM$BIND_DBR_LOG_FILE" = "DBR_PID.OUT" (LNM$SYSTEM_TABLE)
"RDM$BIND_HOT_OUTPUT_FILE" = "AIJSERVER_PID.OUT" (LNM$SYSTEM_TABLE)
"RDM$BIND_LCS_OUTPUT_FILE" = "LCS_PID.OUT" (LNM$SYSTEM_TABLE)
"RDM$BIND_LRS_OUTPUT_FILE" = "LRS_PID.OUT" (LNM$SYSTEM_TABLE)
"RDM$BIND_RCS_LOG_FILE" = "RCS_PID.OUT" (LNM$SYSTEM_TABLE)
"RDM$BIND_RCS_LOG_HEADER" = "0" (LNM$SYSTEM_TABLE)
"RDM$BUGCHECK_DIR" = "DISK$RANDOM:[BUGCHECKS.RDBHR]" (LNM$SYSTEM_TABLE)
"RDM$MONITOR" = "SYS$SYSROOT:[SYSEXE]" (LNM$SYSTEM_TABLE)
```

Example 2

This example displays both defined and undefined logical names.

```
$ rmu/sho log /undefined ! Display them all
"RDM$AUTO_READY" = Undefined
"RDM$BIND_ABS_GLOBAL_STATISTICS" = Undefined
"RDM$BIND_ABS_LOG_FILE" = "ABS_PID.OUT" (LNM$SYSTEM_TABLE)
"RDM$BIND_ABS_OVERWRITE_ALLOWED" = Undefined
"RDM$BIND_ABS_OVERWRITE_IMMEDIATE" = Undefined
"RDM$BIND_ABS_QUIET_POINT" = Undefined
"RDM$BIND_ABS_PRIORITY" = Undefined
"RDM$BIND_ABW_ENABLED" = Undefined
"RDM$BIND_AIJ_ARB_COUNT" = Undefined
.
.
.
```

RMU Show Optimizer_Statistics Command

1.61.6 RMU Show Optimizer_Statistics Command

Displays the current values of the optimizer statistics for tables and indexes as stored in the RDB\$INDICES, RDB\$RELATIONS, and the RDB\$WORKLOAD system table.

Format

RMU/Show Optimizer_Statistics root-file

<u>Command Qualifiers</u>	<u>Defaults</u>
/[No]Full	/Nofull
/[No]Indexes[=(index-list)]	/Index
/[No]Log[=file-name]	/Log
/Statistics[=(options)]	/Statistics
/[No]System_Relations	/Nosystem_Relations
/[No]Tables[=(table-list)]	/Tables
/[No]Threshold[=options]	/Nothreshold

Command Parameters

root-file-spec

Specifies the database for which optimizer statistics are to be displayed. The default file type is .rdb.

Command Qualifiers

Full

Nofull

This qualifier can only be used if table, index, or index prefix cardinality statistics are being displayed. If this qualifier is specified, the following cardinality information is displayed:

- **Actual cardinality**
Displays the current table, index, or index prefix cardinality value.
- **Stored cardinality**
Displays the table, index, or index prefix cardinality value stored in the system relations.
- **Difference between the stored and actual cardinality values**

RMU Show Optimizer_Statistics Command

This value is negative if the stored cardinality is less than the actual cardinality.

- Percentage cardinality difference from the actual value

This value is calculated by dividing the difference between the stored and actual cardinality values by the actual cardinality value. It is negative if the stored cardinality is less than the actual cardinality.

The default value is Nofull.

Indexes

Indexes[(index-list)]

Noindex

Specifies the index or indexes for which statistics are to be displayed. If you do not specify an index-list, statistics for all indexes defined for the tables specified with the Tables qualifier are displayed. If you specify an index-list, statistics are displayed only for the named indexes. If you specify the Noindex qualifier, statistics are not displayed for any indexes.

The default is the Indexes qualifier without an index-list.

Log

Log=file-name

Nolog

Specifies whether the display of statistics are to be logged. Specify the Log qualifier to have the information displayed to SYS\$OUTPUT. Specify the Log=file-spec qualifier to have the information written to a file. The Nolog qualifier is valid syntax, but is ignored by Oracle RMU. The default is the Log qualifier.

Statistics[(options)]

Specifies the type of statistics you want to display for the items specified with the Tables, System_Relations, and Indexes qualifiers. If you specify the Statistics qualifier without an options list, all statistics are displayed for the items specified.

If you specify the Statistics qualifier with an options list, Oracle RMU displays the types of statistics described in the following list. If you specify more than one option, separate the options with commas and enclose the options within parentheses.

The Statistics qualifier options are:

- Cardinality

RMU Show Optimizer_Statistics Command

Displays the table cardinality for the tables specified with the Tables and System_Relations qualifiers and the index and index prefix cardinalities for the indexes specified with the Indexes qualifier.

- **Workload**

Displays the Column Group, Duplicity Factor, and Null Factor workload statistics for the tables specified with the Tables and System_Relations qualifiers.

- **Storage**

Displays the following statistics:

- Table Row Clustering Factor for the tables specified with the Tables qualifier
- Index Key Clustering Factor, the Index Data Clustering Factor, and the Average Index Depth for the indexes specified with the Indexes qualifier.

System_Relations

Nosystem_Relations

The System_Relations qualifier specifies that optimizer statistics are to be displayed for system tables (relations) and their associated indexes.

If you do not specify the System_Relations qualifier, or if you specify the Nosystem_Relations qualifier, optimizer statistics are not displayed for system tables or their associated indexes.

Specify the Noindex qualifier if you do not want statistics displayed for indexes defined on the system tables.

The default is the Nosystem_Relations qualifier.

Tables

Tables=(table-list)

Notables

Specifies the table or tables for which optimizer statistics are to be displayed.

If you specify a table-list, optimizer statistics for those tables and their associated indexes are displayed.

If you do not specify the Tables qualifier, or if you specify the Tables qualifier but do not provide a table-list, optimizer statistics for all tables and their associated indexes in the database are displayed.

If you specify the Notables qualifier, optimizer statistics for tables are not displayed.

RMU Show Optimizer_Statistics Command

Specify the Noindex qualifier if you do not want statistics displayed for indexes defined on the specified tables.

The Tables qualifier is the default.

Threshold=options

Nothreshold

The Threshold qualifier can only be used in conjunction with the Full qualifier. If this qualifier is used, an additional Threshold column is added to the display. You can specify the following options with the Threshold qualifier:

- Percent=*n*
The value for Percent=*n* can be an integer value from 0 to 99. The default value for *n* is 0. If Percent=*n* is not specified or if a percent value of 0 is specified, any percentage difference from the actual cardinality value is flagged as “*over*” in the output column. If a percent value of 1 to 99 is specified, any percentage difference from the actual cardinality value that is greater than the percent value specified is flagged as “*over*” in the output column. In the report, the Threshold column displays those cardinality values in which the percent difference exceeds the specified value. If the threshold is not exceeded, the column is blank. If the threshold is exceeded, the column shows the string “*over*”.
- Log={All | Over_Threshold}
If Log is not specified or if Log=All is specified, all cardinality values are displayed. If Log=Over_Threshold is specified, only cardinality values that exceed the threshold percentage are flagged as “*over*” in the output column.

Usage Notes

- To use the RMU Show Optimizer_Statistics command for a database, you must have the RMU\$ANALYZE or RMU\$SHOW privilege in the root file access control list (ACL) for the database or the OpenVMS SYSPRV or BYPASS privilege.
- Cardinality statistics are automatically maintained by Oracle Rdb. Physical storage and Workload statistics are only collected when you issue an RMU Collect Optimizer_Statistics command. To get information about the usage of Physical storage and Workload statistics for a given query, define the RDMS\$DEBUG_FLAGS logical name to be "O". For example:

RMU Show Optimizer_Statistics Command

```
$ DEFINE RDMS$DEBUG_FLAGS "0"
```

When you execute a query, if workload and physical statistics have been used in optimizing the query, you will see a line such as the following in the command output:

```
~0: Workload and Physical statistics used
```

- Use the RMU Show Optimizer Statistics command with the Statistics=Cardinality/Full/Threshold=n qualifier to identify index prefix cardinality drift. This command identifies indexes that need to be repaired. Use the RMU Collect Optimizer_Statistics command to repair the stored index prefix cardinality values.

Examples

Example 1

The following command displays all optimizer statistics previously collected for the EMPLOYEES table. See Section 1.15 for an example that demonstrates how to collect optimizer statistics.

```
$ RMU/SHOW OPTIMIZER_STATISTICS MF_PERSONNEL.RDB /TABLE=(EMPLOYEES)
```

```
-----  
Optimizer Statistics for table : EMPLOYEES  
  
Cardinality          : 100  
Row clustering factor : 0.5100000  
  
Workload Column group :      EMPLOYEE_ID  
Duplicity factor      : 1.0000000  
Null factor           : 0.0000000  
First created time    : 3-JUL-1996 10:37:36.43  
Last collected time   : 3-JUL-1996 10:46:10.73  
  
Workload Column group : LAST_NAME,  FIRST_NAME,  MIDDLE_INITIAL,  
ADDRESS_DATA_1, ADDRESS_DATA_2, CITY,   STATE,   POSTAL_CODE,   SEX,  
BIRTHDAY,           STATUS_CODE  
Duplicity factor      : 1.5625000  
Null factor           : 0.3600000  
First created time    : 3-JUL-1996 10:37:36.43  
Last collected time   : 3-JUL-1996 10:46:10.74  
  
Index name : EMP_LAST_NAME  
Index Cardinality : 83  
Average Depth    : 2.0000000  
Key clustering factor : 0.0481928  
Data clustering factor : 1.1686747  
Segment Column           Prefix cardinality  
LAST_NAME                0
```

RMU Show Optimizer_Statistics Command

```
Index name : EMP_EMPLOYEE_ID
Index Cardinality      : 0
Average Depth         : 2.0000000
Key clustering factor  : 0.0100000
Data clustering factor : 0.9500000
Segment Column        Prefix cardinality
EMPLOYEE_ID           0

Index name : EMPLOYEES_HASH
Index Cardinality      : 0
Key clustering factor  : 1.0000000
Data clustering factor : 1.0000000
```

Example 2

The following command displays optimizer statistics for all the tables defined in the database. Because the Noindex qualifier is specified, no index statistics are displayed. Because the Log qualifier is specified with a file specification, the values for the optimizer statistics are written to the specified file.

```
$ RMU/SHOW OPTIMIZER_STATISTICS mf_personnel.rdb -
_$_ /NOINDEX/LOG=NOINDEX-STAT.LOG
```

Example 3

The following example displays the output of a command when the Full and Threshold qualifiers are used with the Cardinality option. In the example, table XXX has three indexes. Index XXX_IDX_FULL has index prefix cardinality collection enabled full and the report shows no cardinality drift for this index. Index XXX_IDX_APPROX has index prefix cardinality collection enabled, and cardinality drift is evident. For the first segment of the index (column C1), the stored cardinality is 20% lower than the actual cardinality. Since the command specifies a threshold of 5%, the line is marked “*over*” in the Thresh column. There is also cardinality drift for the second segment of the index (column C2), index prefix (C1, C2). The third index XXX_IDX_NONE has index prefix cardinality collection disabled. This is indicated in the report rather than showing the index segments. If the report were lengthy, you could write it to a disk file and then locate the problem indexes by searching for the string “*over*”.

```
$ RMU/SHOW OPTIMIZER/STAT=CARD/FULL/THRESH=(percent=5,log=all) sample.rdb
Optimizer Statistics for table : XXX
(Cardinality: Diff=Stored-Actual, Percent=Diff/Actual, Thresh=Percent exceeded)
Table cardinality
Actual          Stored          Diff          Percent Thresh
109586          109586          0             0 %
```

RMU Show Optimizer_Statistics Command

```

Index name : XXX_IDX_FULL
(Cardinality: Diff=Stored-Actual, Percent=Diff/Actual, Thresh=Percent exceeded)
      Actual          Stored          Diff          Percent Thresh
      109586         109586           0            0 %
      Index cardinality
      Prefix cardinality
      Actual          Stored          Diff          Percent Thresh
Segment Column : C1
      1425           1425            0            0 %
Segment Column : C2
      31797          31797           0            0 %
Segment Column : C3
      0              0               0            0 %

Index name : XXX_IDX_APPROX
(Cardinality: Diff=Stored-Actual, Percent=Diff/Actual, Thresh=Percent exceeded)
      Actual          Stored          Diff          Percent Thresh
      109586         109586           0            0 %
      Index cardinality
      Prefix cardinality
      Actual          Stored          Diff          Percent Thresh
Segment Column : C1
      1425           1140            -285         -20 %   *over*
Segment Column : C2
      31797          30526           -1271        -4 %
Segment Column : C3
      0              0               0            0 %

Index name : XXX_IDX_NONE
(Cardinality: Diff=Stored-Actual, Percent=Diff/Actual, Thresh=Percent exceeded)
      Actual          Stored          Diff          Percent Thresh
      109586         109586           0            0 %
***Prefix cardinality collection is disabled***

```

RMU Show Privilege Command

1.61.7 RMU Show Privilege Command

Allows you to display the root file access control list (ACL) for a database.

Format

RMU>Show Privilege root-file-spec

<u>Command Qualifiers</u>	<u>Defaults</u>
[No]Expand_All	/Noexpand_All
[No]Header	/Header

Command Parameters

root-file-spec

The root file specification for the database whose root file ACL you are displaying. By default, a file extension of .rdb is assumed.

Command Qualifiers

Expand_All

Noexpand_All

Specifies that if a user's access mask was defined with the RMU\$ALL keyword on the RMU Set Privilege command, each of the RMU privileges represented by the RMU\$ALL keyword is displayed.

The Noexpand_All qualifier specifies that if a user's access mask was defined with the RMU\$ALL keyword on the RMU Set Privilege command, only the keyword is displayed; the RMU privileges represented by the keyword are not displayed.

The Noexpand_All qualifier is the default.

Header

Noheader

Specifies that header information is to be displayed. The Noheader qualifier suppresses output of header information.

The Header qualifier is the default.

RMU Show Privilege Command

Usage Notes

- To use the RMU Show Privilege command for a database, you must have the RMU\$SECURITY privilege in the root file ACL for the database or the OpenVMS SECURITY or BYPASS privilege.
- Although you can use the DCL SHOW ACL command to display the root file ACL for a database, the DCL SHOW ACL command does not display the names of the Oracle RMU privileges granted to users.

Examples

Example 1

In the following example, the RMU Show Privilege command displays the root file ACL for the mf_personnel database:

```
$ RMU/SHOW PRIVILEGE MF_PERSONNEL.RDB
Object type: file, Object name: SQL_USER:[USER1]MF_PERSONNEL.RDB;1,
on 12-FEB-1996 10:48:23.04

( IDENTIFIER= [SQL, USER1], ACCESS=READ+WRITE+CONTROL+RMU$ALTER+
RMU$ANALYZE+RMU$BACKUP+RMU$CONVERT+RMU$COPY+RMU$DUMP+RMU$LOAD+
RMU$MOVE+RMU$OPEN+RMU$RESTORE+RMU$SECURITY+RMU$SHOW+RMU$UNLOAD+
RMU$VERIFY)
( IDENTIFIER= [SQL, USER2], ACCESS=READ+WRITE+RMU$ALTER+RMU$ANALYZE+
RMU$BACKUP+RMU$CONVERT+RMU$COPY+RMU$DUMP+RMU$LOAD+RMU$MOVE+RMU$OPEN+
RMU$RESTORE+RMU$SHOW+RMU$UNLOAD+RMU$VERIFY)
( IDENTIFIER= [SQL, USER3], ACCESS=READ+WRITE+CONTROL+RMU$SECURITY)
```

Example 2

The following examples demonstrate the difference in output when you use the Header and Noheader qualifiers:

```
$ RMU/SHOW PRIV MF_PERSONNEL.RDB/HEADER
Object type: file, Object name: RDBVMS_USER:[DB]MF_PERSONNEL.RDB;1,
on 17-SEP-1998 13:47:20.21
( IDENTIFIER= [RDB, STONE], ACCESS=RMU$ALL)

$ RMU/SHOW PRIVILEGE MF_PERSONNEL.RDB/NOHEADER
( IDENTIFIER= [RDB, STONE], ACCESS=RMU$ALL)
```

Example 3

The following examples demonstrate the difference in output when you use the Expand and Noexpand qualifiers:

RMU Show Privilege Command

```
$ RMU/SET PRIVILEGE MF_PERSONNEL.RDB /ACL=(I=STONE,A=RMU$ALL)
$ RMU/SHOW PRIVILEGE MF_PERSONNEL.RDB /NOEXPAND/NOHEADER
(IDENTIFIER=[RDB,STONE],ACCESS=READ+WRITE+CONTROL+RMU$ALL)
$ RMU/SHOW PRIVILEGE MF_PERSONNEL.RDB /EXPAND/NOHEADER
(IDENTIFIER=[RDB,STONE],ACCESS=READ+WRITE+CONTROL+RMU$ALTER+
  RMU$ANALYZE+RMU$BACKUP+RMU$CONVERT+RMU$COPY+RMU$DUMP+RMU$LOAD+
  RMU$MOVE+RMU$OPEN+RMU$RESTORE+RMU$SECURITY+RMU$SHOW+RMU$UNLOAD+
  RMU$VERIFY)
```

RMU Show Statistics Command

1.61.8 RMU Show Statistics Command

Opens the Performance Monitor to display, on a character-cell terminal, the usage statistics for a database. See the *Oracle Rdb7 Guide to Database Performance and Tuning* for tutorial information on how to interpret the Performance Monitor displays.

Format

RMU/Show Statistics [root-file-spec]

Command Qualifiers

/Access_Log
/Alarm=interval
/[No]Broadcast
/[No]Cluster=[(node-list)]
/Configure=file-spec
/[No]Cycle=seconds
/Dbkey_Log=file-spec
/Deadlock_Log=file-spec
/[No]Histogram
/Hot_Standby_Log
/Input = file-name
/[No]Interactive
/Lock_Timeout_Log=file-spec
/[No]Log
/[No]Logical_Area
/[No]Notify=[([No]All | operator-classes)]
/[No]Opcom_Log=filename

/Options=keywords
/Output=file-spec
/[No]Prompt_Timeout=seconds
/Reopen_Interval= minutes
/Reset
/Screen = screen-name
/Stall_Log = file-spec
/Time = integer
/Until = date-time

Defaults

None
/Alarm=0
See description
/Nocluster
None
/Nocycle
See description
None
/Histogram
None
See description
See description
None
See description
/Logical_Area
/Nonotify
/Noopcom_Log

/Options=Base
See description
/Prompt_Timeout=60
None
Statistics are no
See description
Stall messages no
/Time = 3
See description

RMU Show Statistics Command

Description

The Performance Monitor dynamically samples activity statistics on a database. You can display the statistics at your terminal and can also write them to a formatted binary file.

The statistics show activity only from the node on which you execute the command.

The Performance Monitor operates in one of three modes: online, record, and replay. In online mode, you can display or record current activity on a database. In record mode, you can record statistics in a binary file. In replay mode, you can examine a previously recorded binary statistics file.

If you use the Input qualifier, the Performance Monitor executes in replay mode. In replay mode, this command generates an interactive display from a previously recorded binary statistics file.

If you do not use the Input qualifier, you must specify a database file name. The Performance Monitor then executes in online mode. In online mode, the command generates an interactive display when you use the Interactive qualifier and can also record statistics in a binary file.

The interactive display is made up of numerous output pages. You control the interactive display by means of menus, arrow keys, and the Return key to select options. You select an item by pressing the arrow keys until the desired item is highlighted, then press the Return key.

Display the Select Display options (by typing D) from the Performance Monitor screen to view the available output pages. Items in the Display menu followed by this set of characters: [->, indicate that a submenu is displayed when you select this item.

Once you have selected a display, there are a number of methods you can use to navigate through the screens:

- To move to the next screen of information, do one of the following:
 - Press the right arrow (→) keyboard key.
 - Press the Next Screen keyboard key.
- To move to the previous screen of information, do one of the following:
 - Press the left arrow (←) keyboard key.
 - Press the Prev Screen keyboard key.
- To move forward *n* number of screens, press the plus (+) keyboard key and enter the value *n*.

RMU Show Statistics Command

- To move backward n number of screens, press the minus (-) keyboard key and enter the value n .
- To move directly from the first screen to the last screen, do one of the following:
 - Press the up arrow (↑) keyboard key.
 - Press the plus (+) keyboard key and enter the value 0.
- To move directly from the last screen to the first screen, do one of the following:
 - Press the down arrow (↓) keyboard key.
 - Press the hyphen (-) keyboard key and enter the value 0.
- To quickly locate a screen in the current submenu group that contains activity, press the space bar on your keyboard.

This feature works even when you are replaying a binary input file. If there is no screen in the current subgroup that has activity, the next screen is displayed (as though you had used the Next Screen key).

The Performance Monitor ignores computational screens, such as Stall Messages, Monitor Log, and so on, when searching for activity.

In interactive mode, enter an exclamation point to open the Select Tool menu. This menu allows you to switch the database for which you are displaying statistics, edit a file, invoke a system command, and so on. (The ability to open a new database is not available if you specify the Input or Output qualifier.) In addition, it provides you the ability to locate a specific statistics screen either by name (or portion thereof) or by a summary-selection menu. Select the Goto screen or Goto screen "by-name" options from the Select Tool menu to use these options.

In interactive mode, you can pause output scrolling on your screen by pressing the P key. Resume output scrolling by pressing the P key again.

An extensive online help facility for the character-cell interface is available by doing the following from the Performance Monitor screen:

1. Type H or PF2.
2. Select the type of help you want (keyboard, screen, or field).
3. Press the Return key.

If you select field level help, you must also do the following:

1. Highlight the field for which you want help information.

RMU Show Statistics Command

2. Press the Return key.

All screens regardless of format or display contents have a standard format as follows:

- First line
Contains the node name, the utility name and version number, and the current system date and time. The current system date and time are updated at the specified set-rate interval.
- Second line
Contains the screen refresh rate, in seconds; the current screen name; and the elapsed time since the last set-rate command, which indicates how long the screen information has been collected.
- Third line
Contains the current page number within the screen (screen *X* of *Y*), the name of the current database, and the statistics utility operation mode (online, record, or replay). Online mode is the normal database activity displayed in real time. Record mode indicates that the database activity being displayed is being recorded to an external file specified by the Output qualifier. Replay mode indicates that the database activity is being displayed from the external file specified by the Input qualifier.

You can display most statistics in either a histogram or a columnar chart, although several display pages have special formats. By default, the initial interactive display appears in histogram mode; by using the `Nohistogram` qualifier, you can direct Oracle RMU to display statistics in tabular numeric mode.

In addition, you can produce time-plot graphics for individual statistical fields.

Use the Output qualifier to direct statistical output to a file. The output is a formatted binary file and does not produce a legible printed listing. To read the output, you must use the RMU Show Statistics command with the Input qualifier.

The `Nointeractive` qualifier suppresses the interactive display. Use this qualifier when you want to generate binary statistics output but do not want an online display.

Database statistics are maintained in a global section on each system on which Oracle Rdb is running. Statistics are reset to zero when you close a database. Running the Performance Monitor keeps the database open even when there are no users accessing the database.

RMU Show Statistics Command

The Stall Messages display permits you to display multiple screens of information. Access the Stall Messages display by selecting Per-Process Information from the Select Display Menu; then select the Stall Messages display from the secondary menu.

If you are displaying the last screen of Stall Messages information and the number of stalled processes is reduced such that the last screen is empty, you are automatically moved to the newest last screen of information when you press the Next Screen keyboard key (or the right arrow keyboard key).

You can also use the Alarm, Notify, and Screen qualifiers to simplify monitoring stalled processes. See the description of each of these qualifiers for more information.

Command Parameters

root-file-spec

The root file specification of the database on which you want statistics. If you use the Input qualifier to supply a prerecorded binary statistics file, you cannot specify a database file name. If you do not use the Input qualifier, you must specify a database file name.

Command Qualifiers

Access_Log

Identifies the name of the log file where logical area accesses are to be recorded.

Alarm=interval

Establishes an alarm interval (in seconds) for the Stall Messages screen from the command line. This is useful when you plan to submit the RMU Show Statistics command as a batch job.

Use this qualifier in conjunction with the Notify qualifier to notify an operator or set of operators of stalled processes.

The default value is 0 seconds, which is equivalent to disabling notification.

Broadcast

Nobroadcast

Specifies whether or not to broadcast messages. The Broadcast qualifier is the default, if broadcasting of certain messages has been enabled with DCL SET BROADCAST. If broadcasting has been disabled with the DCL SET BROADCAST=none command, broadcast messages are not displayed, even if you specify the RMU Show Statistics command with the Broadcast qualifier.

RMU Show Statistics Command

Specify the Nobroadcast qualifier if broadcasting has been enabled with the DCL SET BROADCAST command but you do not want broadcast messages displayed while you are running the Performance Monitor.

Cluster=(node-list)

Nocluster

Specifies the list of remote nodes from which statistics collection and presentation are to be performed. The collected statistics are merged with the information for the current node and displayed using the usual statistics screens.

The following list summarizes usage of the Cluster qualifier:

- If the Cluster qualifier is specified by itself, remote statistics collection is performed on all cluster nodes on which the database is currently open.
- If the Cluster=(node-list) qualifier is specified, remote statistics collection is performed on the specified nodes only, even if the database is not yet open on those nodes.
- If the Cluster qualifier is not specified, or the Nocluster qualifier (the default) is specified, cluster statistics collection is not performed. However, you can still enable clusterwide statistics collection online using the Tools menu.

You can specify up to 95 different cluster nodes with the Cluster qualifier. There is a maximum number of 95 cluster nodes because Oracle Rdb supports only 96 nodes per database. The current node is always included in the list of nodes from which statistics collection is to be performed.

It is not necessary to have the RMU Show Statistics command running on the specified remote nodes or to have the database open on the remote nodes. These events are automatically handled by the feature.

The following example shows the use of the Cluster qualifier to initiate statistics collection and presentation from two remote nodes:

```
$ RMU /SHOW STATISTICS /CLUSTER=(BONZAI, ALPHA4) MF_PERSONNEL
```

Remote nodes can also be added and removed online at run time. Use the Cluster Statistics option located in the Tools menu. The Tools menu is displayed by using the exclamation point (!) on-screen menu option.

See the *RMU Show Statistic DBA Handbook* (available in MetaLink if you have a service contract) for information about the Cluster Statistics Collection and Presentation feature.

RMU Show Statistics Command

Configure=file-spec

Specifies the name of a human-readable configuration file to be processed by the RMU Show Statistics command. The configuration file can be created using any editor, or it can be automatically generated from the RMU Show Statistics command using the current run-time configuration settings. The default configuration file type is .cfg.

If you specify the Configure=file-spec qualifier, the configuration file is processed by the RMU Show Statistics command prior to opening the database or the binary input file. If you do not specify this qualifier, all of the variables are the defaults based on command-line qualifiers and logical names.

The configuration file is processed in two passes. The first pass occurs before the database is opened and processes most of the configuration file entries. The second pass occurs after the database is opened and processes those variables that are database-dependent, such as the CUSTOMER_LINE_n variable.

See the *RMU Show Statistic DBA Handbook* (available in MetaLink if you have a service contract) for more information about configuration files.

Cycle=seconds

Nocycle

Directs the Performance Monitor to continually cycle through the set of screens associated with the currently selected menu item. Each menu is displayed for the number of seconds specified.

When you specify the Cycle qualifier, you can change screen modes or change submenus as desired; cycling through the menus associated with your choice continues at whichever menu level is currently selected.

The specified value for the Cycle qualifier must be greater than or equal to the value specified for the Time qualifier. In addition, if you manually change the refresh rate (using the Set_rate onscreen menu option) to a value that is greater than the value you specify with the Cycle qualifier, the cycling is performed at the interval you specify for the Set_rate.

If you do not specify the Cycle qualifier, or if you do not specify the number of seconds, no screen cycling is performed.

Dbkey_Log=file-spec

Logs the records accessed during a given processing period by the various attached processes. The file-spec is the name of the file to which all accessed dbkeys are logged.

RMU Show Statistics Command

The header region of the dbkey log contains four lines. The first line indicates that the RMU Show Statistic utility created the log file. The second line identifies the database. The third line identifies the date and time the dbkey log was created. The fourth line is the column heading line.

The main body of the dbkey log contains six columns. The first column contains the dbkey process ID and stream ID. The second through sixth columns contain the most recently accessed dbkey for a data page, snapshot page, SPAM page, AIP page, and ABM page, respectively.

Only one message per newly accessed dbkey is recorded. However, all dbkey values are displayed, even if some of the dbkeys did not change.

The dbkey information is written at the current screen refresh rate, determined by the Time qualifier or the Set_rate onscreen menu option. Using a larger refresh rate minimizes the size of the file but results in a large number of missed dbkey messages. Using a smaller refresh rate produces a large log file, but contains a much finer granularity of dbkey messages.

Note that you do not need to display the Dbkey Information screen in order to record the dbkey messages to the dbkey log. The dbkey log is maintained regardless of which screen, if any, is displayed.

You can use the Dbkey_Log qualifier to construct a dbkey logging server, as follows:

```
$ RMU/SHOW STATISTICS/NOHISTOGRAM/TIME=1 -  
_$_ /NOINTERACTIVE/DBKEY_LOG=DBKEY.LOG MF_PERSONNEL -  
_$_ /NOBROADCAST/UNTIL="15:15:00"
```

Deadlock_Log=file-spec

Records the last deadlock for the processes. There is no method to record each lock deadlock as it occurs.

The file-spec in the qualifier is the name of the file to which you want all lock deadlock messages to be logged. The lock deadlock messages are written in human-readable format similar to the Lock Timeout History and Lock Deadlock History screens.

The header region of the lock deadlock log contains three lines:

- Line 1 indicates that the RMU Show Statistics utility created the log file.
- Line 2 identifies the database.
- Line 3 identifies the date and time the log was created.

RMU Show Statistics Command

The main body of the stall log contains three columns:

- The first column contains the process ID and stream ID that experienced the lock deadlock.
- The second column contains the time the deadlock occurred; however, the date is not displayed.
- The third column contains the deadlock message describing the affected resource. This message is similar to the originating stall message.

For example:

```
2EA00B52:34 14:25:46.14 - waiting for page 5:751 (PR)
```

If any lock deadlocks are missed for a particular process (usually because the recording interval is too large), the number of missed lock deadlocks is displayed in brackets after the message. For example:

```
2EA00B52:34 14:25:46.14 - waiting for page 5:751 (PR) [1 missed]
```

Only one message is logged for each deadlock.

The lock deadlock messages are written at the specified screen refresh rate, determined by specifying the Time qualifier, or online using the Set_rate on-screen menu option. Using a larger refresh rate minimizes the size of the file, but results in a large number of missed deadlock messages. Using a smaller refresh rate produces a large log file, but contains a much finer granularity of deadlock messages.

Using the Time=1 or Time=50 qualifier produces a reasonable log while minimizing the impact on the system.

The affected LockID is not displayed, because this is meaningless information after the lock deadlock has completed.

Use the Tools menu (displayed when you press the exclamation point (!) key from any screen) to enable or disable the lock timeout and lock deadlock logging facility while the RMU Show Statistics utility is running. However, note that the lock timeout log and lock deadlock log are not available during binary file replay.

Histogram

Nohistogram

Directs Oracle RMU to display the initial statistics screen in the numbers display mode or the graph display mode. The Histogram qualifier specifies the graph display mode. The Nohistogram qualifier specifies the numbers display mode.

The Histogram qualifier is the default.

RMU Show Statistics Command

Hot_Standby_Log

Specifies the name of the Hot Standby log file. The "Start hot standby logging" option of the Tools menu (enter !) can be used to specify the name of the Hot Standby log file at runtime.

Input=file-name

Specifies the prerecorded binary file from which you can read the statistics. This file must have been created by an earlier RMU Show Statistics session that specified the Output qualifier.

You cannot specify a database file name with the Input qualifier. Also, you must not use the Until, Output, or Nointeractive qualifiers with the Input qualifier. However, you can use the Time qualifier to change the rate of the display. This will not change the computed times as recorded in the original session. For example, you can record a session at Time=60. This session will gather statistics once per minute.

You can replay statistics gathered in a file by using the Input and Time qualifiers. To replay a file:

- Use the Output qualifier to create a file of database statistics.
- Use the Input and Time qualifiers to view the statistics again at a rate that you determine. For example, the command `RMU/SHOW STATISTICS PERS.LOG/TIME=1`, will replay the PERS.LOG file and change the display once per second, thus replaying 10 hours of statistics in 10 minutes.

If you do not specify the Input qualifier, you must specify the root-file-spec parameter.

Interactive

Nointeractive

Displays the statistics dynamically to your terminal. The Interactive qualifier is the default when you execute the RMU Show Statistics command from a terminal. You can use the Nointeractive qualifier with the Output qualifier to generate a binary statistics file without generating a terminal display. The Nointeractive qualifier is the default when you execute the RMU Show Statistics command from a batch job.

In an interactive session, you can use either the menu interface or the predefined control characters to select display options (see the Performance Monitor online help for further information about the predefined control characters).

Select menu options by using the up (↑) and down (↓) arrow keys followed by pressing the Return or Enter key. Cancel the menu by pressing Ctrl/Z.

RMU Show Statistics Command

Lock_Timeout_Log=file-spec

Records the last lock timeout message for the processes. There is no method to record each lock timeout as it occurs. The lock timeout messages are written in human-readable format.

The header region of the lock timeout log contains three lines:

- Line 1 indicates that the RMU Show Statistics utility created the log file.
- Line 2 identifies the database.
- Line 3 identifies the date and time the log was created.

The main body of the stall log contains three columns:

- The first column contains the process ID and stream ID that experienced the lock timeout.
- The second column contains the time the timeout occurred; however, the date is not displayed.
- The third column contains the timeout message describing the affected resource. This message is similar to the originating stall message.

For example:

```
2EA00B52:34 14:25:46.14 - waiting for page 5:751 (PR)
```

If any lock timeouts are missed for a particular process (usually because the recording interval is too large), the number of missed lock timeouts is displayed in brackets after the message. For example:

```
2EA00B52:34 14:25:46.14 - waiting for page 5:751 (PR) [1 missed]
```

Only one message is logged for each lock timeout.

The lock timeout messages are written at the specified screen refresh rate, determined by specifying the `Time` qualifier, or online using the `Set_rate` on-screen menu option. Using a larger refresh rate minimizes the size of the file, but results in a large number of missed lock timeout messages. Using a smaller refresh rate produces a large log file, but contains a much finer granularity of lock timeout messages.

Using the `Time=1` or `Time=50` qualifier appears to produce a reasonable log while minimizing the impact on the system.

The affected LockID is not displayed because this is meaningless information after the lock timeout has completed.

RMU Show Statistics Command

Note that you do not need to be displaying the Lock Timeout History or Lock Deadlock History screens to record the stall messages to the stall log. These logs are maintained regardless of which screen, if any, is displayed.

Use the Tools menu (displayed when you press the exclamation point (!) key from any screen) to enable or disable the lock timeout and lock deadlock logging facility while the RMU Show Statistics utility is running. However, note that the lock timeout log and lock deadlock log are not available during binary file replay.

Log

Nolog

Logs the creation of a binary statistics file to your output file. This binary statistics file is created only if you have used the Output qualifier. If you use the Nolog qualifier, no operations will be logged to your output file.

The default is the current setting of the DCL verify switch. See `HELP SET VERIFY` in `DCL HELP` for more information on changing the DCL verify switch.

If you use the Interactive qualifier, the Log qualifier is ignored.

Logical_Area

Nological_Area

Specifies that you want the RMU Show Statistics command to acquire the needed amounts of virtual memory to display logical area statistics information. The Logical_Area qualifier is the default.

By default, the RMU Show Statistics command consumes approximately 13,000 bytes of virtual memory per logical area. (The number of logical areas is determined by the largest logical area identifier — not by the actual number of areas.) This can result in the RMU Show Statistics command consuming large amounts of virtual memory, even if you do not want to review logical area statistics information.

Use the NoLogical_Area qualifier to indicate that you do not want to display logical area statistics information. When you specify the NoLogical_Area qualifier, the virtual memory for logical area statistics information presentation is not acquired.

When you specify the NoLogical_Area qualifier, do not also specify the Nolog qualifier, as this causes logical area statistics information to still be collected.

There is no corresponding configuration variable. This qualifier cannot be modified at run time. See the *RMU Show Statistic DBA Handbook* (available in MetaLink if you have a service contract) for more information about interpreting logical area screens.

RMU Show Statistics Command

Notify

Notify=[No]All

Notify=operator-classes

Nonotify

Notifies the specified system operator or operators when a stall process exceeds the specified alarm interval by issuing a broadcast message and ringing a bell at the terminal receiving the message.

The valid operator classes are: CENTRAL, CLUSTER, DISKS, OPCOM, SECURITY, and OPER1 through OPER12.

The various forms of the Notify qualifier have the following effects:

- If you specify the Notify qualifier without the operator-classes parameter, the CENTRAL and CLUSTER operators are notified by default.
- If you specify the Nonotify or Notify=Noall qualifiers, operator notification is disabled.
- If you specify the Notify=All qualifier, all operator classes are enabled.
- If you specify the Notify=operator-classes qualifier, the specified classes are enabled. (If you specify more than one operator class, enclose the list in parentheses and separate each class name with a comma.)

For example, issuing the RMU Show Statistics command with the Notify=(OPER1, OPER2) qualifier sends a notification message to system operator classes OPER1 and OPER2 if the Alarm threshold is exceeded while monitoring the Stall Messages screen.

- When the Notify=OPCOM qualifier is specified with the RMU Show Statistics command along with the Alarm and Cluster qualifiers, Oracle RMU generates an OPCOM message and delivers it to the OPCOM class associated with the Notify qualifier. This message alerts the operator to the fact that the process has stalled for more than *n* seconds, where *n* is the value assigned to the Alarm qualifier. The process that has stalled may be on any node that is included in the node name list assigned to the Cluster qualifier.

The specified system operator(s) are notified only when the alarm threshold is first exceeded. For instance, if three processes exceed the alarm threshold, the specified operator(s) are notified only once. If another process subsequently exceeds the alarm threshold while the other processes are still displayed, the specified system operator(s) are not notified.

However, if the longest-duration stall is resolved and a new process then becomes the newest stall to exceed the alarm threshold, then the specified system operator(s) will be notified of the new process.

RMU Show Statistics Command

To receive operator notification messages, the following three OpenVMS DCL commands must be issued:

1. `$ SET TERM /BROADCAST`
2. `$ SET BROADCAST=OPCOM`
3. `$ REPLY /ENABLE=(operator-classes)`

The operator-classes specified in the `REPLY /ENABLE` command must match those specified in the Notify qualifier to the RMU Show Statistics command.

The operator notification message will appear similar to the following sample message:

```
%%%%%%%%%% OPCOM 19-DEC-1994 08:56:39.27 %%%%%%%%%%%  
                (from node MYNODE at 19-DEC-1994 08:56:39.30)  
Message from user SMITH on MYNODE  
Rdb Database USER2:[SMITH.WORK.AIJ]MF_PERSONNEL.RDB;1 Event Notification  
Process 2082005F:1 exceeded 5 second stall: waiting for record 51:60:2 (EX)
```

The system operator notification message contains four lines. Line 1 contains the OPCOM broadcast header message. Line 2 identifies the process running the RMU Show Statistics command that sent the message. Line 3 identifies the database being monitored. Line 4 identifies the process that triggered the alarm, including the alarm interval and the stall message.

To establish an alarm interval for the Stall Messages screen, use the `Alarm=Interval` qualifier.

If you specify the `Nointeractive` qualifier, bell notification is disabled, but the broadcast message remains enabled.

Opcom_Log=filename

Noopcom_Log

Specifies the name of the file where OPCOM messages broadcast by attached database processes will be sent.

When recording OPCOM messages, it is possible to occasionally miss a few messages for a specific process. When this occurs, the message "n missed" will be displayed in the log file.

You can record specific operator classes of OPCOM messages if you specify the `Option=Verbose` qualifier. The `Option=Verbose` qualifier records only those messages that can be received by the process executing the RMU Show Statistics utility. For example, if the process is enabled to receive operator class Central, then if you specify `Opcom_Log=opcom.log` the `Option=Verbose` qualifier records all Central operator messages. Conversely, specifying only the `Opcom_Log=opcom.log` qualifier records all database-specific OPCOM

RMU Show Statistics Command

messages generated from this node. Because the output is captured directly from OpenVMS, the operator-specific log file output format is different from the database-specific contents. The following example shows the operator-specific log file contents for the Cluster and Central operator classes:

```
Oracle Rdb X7.1-00 Performance Monitor OPCOM Log
Database KODA_TEST:[R_ANDERSON.TCS_MASTER]TCS.RDB;2
OPCOM Log created 11-JUN-1999 10:52:07.53
11-JUN-1999 10:52:23.85) Message from user RDBVMS on ALPHA4 Oracle Rdb X7.1-00
Event Notification for Database _$111$DUA368:[BBENTON.TEST]MF_PERSONNEL.RDB;1
AIJ Log Server terminated
11-JUN-1999 10:52:25.49) Message from user RDBVMS on ALPHA4 Oracle Rdb X7.1-00
Event Notification for Database _$111$DUA368:[BBENTON.TEST]MF_PERSONNEL.RDB;1
AIJ Log Roll-Forward Server started
11-JUN-1999 10:52:26.06) Message from user RDBVMS on ALPHA4 Oracle Rdb X7.1-00
Event Notification for Database _$111$DUA368:[BBENTON.TEST]MF_PERSONNEL.RDB;1
AIJ Log Roll-Forward Server failed
.
.
.
11-JUN-1999 10:54:21.09) Message from user RDBVMS on ALPHA4 Oracle Rdb X7.1-00
Event Notification for Database _$111$DUA368:[BBENTON.TEST.JUNK]T_
PERSONNEL.RDB;1 AIJ Log Server started
11-JUN-1999 10:54:21.13) Message from user RDBVMS on ALPHA4 Oracle Rdb X7.1-00
Event Notification for Database _$111$DUA368:[BBENTON.TEST.JUNK]T_
PERSONNEL.RDB;1 Opening "$111$DUA368:[BBENTON.TEST.JUNK]TEST1.AIJ;2"
```

Options=[keywords]

The following keywords may be used with the Options qualifier:

- [No]All
Indicates whether or not all collectible statistics (all statistics for all areas) are to be collected. The All option indicates that all statistics information is to be collected; the Noall keyword indicates that only the base statistics information is to be collected. You must also specify the Output qualifier.
- [No]Area
Indicates whether or not the by-area statistics information is to be collected in addition to the base statistics information. When you specify the Area or Noarea option, the Base statistics are implicitly selected. You must also specify the Output qualifier.

When the Area option is specified, statistics for all existing storage areas are written to the binary output file; you cannot selectively choose specific storage areas for which statistic information is to be collected.

RMU Show Statistics Command

The size of the by-area statistics output largely depends on the total number of storage areas in the database, including reserved storage areas. If the database contains a large number of storage areas, it may not be advisable to use the `Options=Area` qualifier.

Before you replay a binary output file that contains by-area statistics, specify the following command to format the display correctly:

```
$ SET TERM/NOTAB
```

You can then replay the statistics as follows:

```
$ RMU/SHOW STATISTICS/INPUT=main.stats
```

- **Base (default)**

Indicates that only the base set of statistics is to be collected; this is the default `Options` option. The base set of statistics is identical to the one collected prior to Oracle Rdb V6.1. You must also specify the `Output` qualifier. You cannot specify `Nobase`.

- **Compress**

Compresses the statistics records written to the output file specified by the `Output` qualifier. While replaying the statistics, the `RMU Show Statistics` command determines if a record was written using compression or not. If the record was written using compression it is automatically decompressed.

If compression is used, the resultant binary file can be read only by the `RMU Show Statistics` command. The format and contents of a compressed file are not documented or accessible to other applications.

- **Confirm**

Indicates that you wish to confirm before exiting from the utility. You can also specify the `Confirm` option in the configuration file using the `CONFIRM_EXIT` variable. A value of `TRUE` indicates that you want to confirm before exiting the utility and a value of `FALSE` (the default) indicates you do not want to confirm before exiting the utility.

- **Log_Stall_Lock**

If you use the `Stall_Log` qualifier to write stall messages to a log file, use the `Nolog_Stall_Lock` option to prevent lock information from being written to the log file. If you use or omit the `Log_Stall_Lock` option, lock information is written to the log file.

- **[No]Row_Cache**

Indicates that all row cache related screens and features of the `RMU Show Statistics` facility are to be displayed. `NoRow_Cache` indicates that these features are disabled.

RMU Show Statistics Command

- **Screen_Name**
Allows you to identify a screen capture by screen name. If you issue an RMU Show Statistics command with the Options=Screen_Name qualifier, the screen capture is written to a file that has the name of the screen with all spaces, brackets, and slashes replaced by underscores. The file has an extension of .SCR. For example, if you use the Option=Screen_Name qualifier and select the Write option on the Screen Transaction Duration (Read/Write), the screen is written to a file named TRANSACTION_DURATION_READ_WRITE.SCR.
- **Update**
Allows you to update fields in the Database Dashboard. See the Performance Monitor Help or the *Oracle Rdb7 Guide to Database Performance and Tuning* for information about using and updating the Database Dashboard. You must have both the OpenVMS WORLD and BYPASS privileges to update fields in the Database Dashboard.
- **Verbose**
Causes the stall message logging facility to report a stall message at each interval, even if the stall message has been previously reported.

Note

Use of the Options=Verbose qualifier can result in an enormous stall messages log file. Ensure that adequate disk space exists for the log file when you use this qualifier.

You can enable or disable the stall messages logging Verbose option at run time by using the Tools menu and pressing the exclamation point (!) key.

You can also specify the Verbose option in the configuration file by using the STALL_LOG_VERBOSE variable. Valid keywords are ENABLED or DISABLED.

Lock information is displayed only once per stall, even in verbose mode, to minimize the output file size.

Output=file-spec

Specifies a binary statistics file into which the statistics are written. Information in the Stall Messages screen is not recorded in this file, however. The information in the Stall Messages screen is highly dynamic and thus cannot be replayed using the Input qualifier.

RMU Show Statistics Command

Note

Statistics from the Stall Messages display are *not* collected in the binary output file.

For information on the format of the binary output file (which changed in Oracle Rdb V6.1), see the *Oracle Rdb7 Guide to Database Performance and Tuning*.

Prompt_Timeout=seconds

Noprompt_Timeout

Allows you to specify the user prompt timeout interval, in seconds. The default value is 60 seconds.

If you specify the Noprompt_Timeout qualifier or the Prompt_Timeout=0, the RMU Show Statistics command does not time out any user prompts. Note that this can cause your database to hang.

Note

Oracle Corporation recommends that you do not use the Noprompt_Timeout qualifier or the Prompt_Timeout= 0 qualifier unless you are certain that prompts will always be responded to in a timely manner.

If the Prompt_Timeout qualifier is specified with a value greater than 0 but less than 10 seconds, the value 10 is used. The user prompt timeout interval can also be specified using the PROMPT_TIMEOUT configuration variable.

Reopen_Interval=minutes

After the specified interval, closes the current output file and opens a new output file without requiring you to exit from the Performance Monitor. The new output file has the same name as the previous output file, but the version number is incremented by 1.

This qualifier allows you to view data written to the output file while the Performance Monitor is running.

If there has been no database activity at the end of the specified interval, the current output file is not closed and a new output file is not created.

Be careful not to use the DCL PURGE command inadvertently. Also note that use of the DCL SET FILE/VERSION_LIMIT command causes older versions of the output file to be deleted automatically.

RMU Show Statistics Command

Use of the `Reopen_Interval` qualifier is only valid when you also specify the `Output` qualifier.

Reset

Specifies that you want the Performance Monitor to reset your display to zero. The `Reset` qualifier has the same effect as selecting the reset option from the interactive screen (except when you specify the `Reset` qualifier, values are reset before being initially displayed).

Note that this qualifier resets the values being displayed to your output device only, it does *not* reset the values in the database global section nor does it affect the data collected in an output file.

The default behavior of the Performance Monitor is to display each change in values that has occurred since the database was opened. To display only the value changes that have occurred since the Performance Monitor was invoked, specify the `Reset` qualifier, or immediately select the on-screen reset option when statistics are first displayed.

The `Reset` qualifier does not affect the values that are written to the binary output file (created when you specify the `Output` qualifier). Specify the `Reset` qualifier when you replay the output file if you want the replay to display only the change in values that occurred between the time the Performance Monitor was invoked (with the `Output` qualifier) and the monitoring session ended.

Screen=screen-name

Specifies the first screen to be displayed. This is particularly useful when you are using the Performance Monitor to interactively monitor stalled processes. For example, the following command automatically warns the system operator of excessive stalls:

```
$ RMU/SHOW STATISTICS/ALARM=5/NOTIFY=OPER12/SCREEN="Stall Messages" -  
_ $ MF_PERSONNEL
```

The following list describes the syntax of the `screen-name` argument:

- You can use any unique portion of the desired screen name for the `screen-name` argument. For example, the following has the same results as the preceding example:

```
$ RMU/SHOW STATISTICS/ALARM=5/NOTIFY=OPER12/SCREEN="Stall" -  
_ $ MF_PERSONNEL.RDB
```

- Except with regards to case, whatever unique portion of the screen you supply must be an exact match to the equivalent portion of the actual screen name.

RMU Show Statistics Command

For example `Screen="Stall"` is equivalent to `Screen="STALL"`; however `Screen="Stalled"` is not.

- If the specified screen-name does not match any known screen name, the display starts with the Summary IO Statistics screen (the default first screen). No error message is produced.
- If the screen name contains spaces, enclose the screen-name in quotes.
- You can not specify the "by-lock" or "by-area" screens.

If you specify the Nointeractive qualifier, the Screen qualifier is ignored.

Stall_Log=file-spec

Specifies that stall messages are to be written to the specified file. This can be useful when you notice a great number of stall messages being generated, but do not have the resources on hand to immediately investigate and resolve the problem. The file generated by the Stall_Log qualifier can be reviewed later so that the problem can be traced and resolved.

The stall messages are written to the file in a format similar to the Stall Messages screen. Stall messages are written to the file at the same rate as the screen refresh rate. (The refresh rate is set with the Time qualifier or from within the Performance Monitor with the Set_rate on-screen menu option.) Specifying a large refresh rate minimizes the size of the file, but results in a large number of missed stall messages. Specifying a small refresh rate produces a large log file, but contains more of the stall messages generated.

You do not need to be displaying the Stall Messages screen to record the stall messages to the log file. The stall log is maintained regardless of which screen, if any, is displayed.

By default, stall messages are not logged to a file.

Time=integer

Specifies the statistics collection interval in seconds. If you omit this qualifier, a sample collection is made every 3 seconds. The integer has a *normal* range of 1 to 180 (1 second to 3 minutes). However, if you specify a negative number for the Time qualifier, the RMU Show Statistics command interprets the number as hundredths of a second. For example, `Time=-20` specifies an interval of 20/100 or 1/5 of a second.

If you are running the RMU Show Statistics command interactively, it updates the screen display at the specified interval.

If you also use the Output qualifier, a binary statistics record is written to the output file at the specified interval. A statistics record is not written to this file if no database activity has occurred since the last record was written.

RMU Show Statistics Command

Until=date-time

Specifies the time the statistics collection ends. When this point is reached, the RMU Show Statistics command terminates and control returns to the system command level. When the RMU Show Statistics command is executed in a batch job, the batch job terminates at the time specified.

An example of using the Until qualifier follows:

```
$ DEFINE LIB$DT_INPUT_FORMAT "!MAU !DB, !Y4 !H04:!M0:!S0.!C2"  
$ RMU/SHOW STATISTICS /UNTIL="JUNE 16, 1996 17:00:00.00" -  
_ $ MF_PERSONNEL
```

This stops execution of the RMU Show Statistics command at 5 P.M. on June 16, 1996. You can omit the date if you wish to use the default of today's date.

You can use either an absolute or delta value to specify the data and time.

If you do not use the Until qualifier, the RMU Show Statistics command continues until you terminate it manually. In an interactive session, terminate the command by pressing Ctrl/Z or by selecting Exit from the menu. When you are running the RMU Show Statistics command with the Nointeractive qualifier from a terminal, terminate the command by pressing Ctrl/C or Ctrl/Y and then selecting Exit. When you are running the RMU Show Statistics command in a batch job, terminate the command by deleting the batch job.

Usage Notes

- Refer to the *Oracle Rdb7 Guide to Database Performance and Tuning* for complete information about the RMU Show Statistics command, including information about using formatted binary output files from the RMU Show Statistics command.
- To use the RMU Show Statistics command for a database, you must have the RMU\$SHOW privilege in the root file ACL for the database or the OpenVMS SYSPRV, BYPASS, or WORLD privilege.
To use the RMU Show Statistics command to display statistics about other users, you must have the OpenVMS WORLD privilege.
To use the RMU Show Statistics command to update fields in the Database Dashboard (specified with the Options=Update qualifier), you must have both the OpenVMS WORLD and BYPASS privileges.

RMU Show Statistics Command

- If a database recovery process is underway, you cannot exit the Performance Monitor using Ctrl/Z or “E” from the interactive display menu. You must use Ctrl/Y or wait for the recovery process to complete. Exiting from the Performance Monitor causes Oracle RMU to request several locks; however, these locks cannot be granted because the recovery process stalls all new lock requests until the recovery is complete.
- Since Oracle Rdb V4.1, a number of changes have been made to the data structures used for the RMU Show Statistics command. If you are having a problem with an application that accesses the RMU Show Statistics field structures, recompile your application with SYS\$LIBRARY:RMU\$SHOW_STATISTICS.CDO (or RMU\$SHOW_STATISTICSnn.CDO in a multiversion environment, where nn is the version of Oracle Rdb you are using).
- The Oracle Rdb RMU Show Statistics command displays process CPU times in excess of 1 day. Because the width of the CPU time display is limited, the following CPU time display formats are used:
 - For CPU time values less than 1 day: "HH:MM:SS.CC"
 - For CPU time values less than 100 days but more than 1 day: "DD HH:MM"
 - For CPU time values more than 100 days: "DDD HH:MM"
- The following caveats apply to the Cluster Statistics Collection and Presentation feature:
 - Up to 95 cluster nodes can be specified. However, use cluster statistics collection prudently, as the system overhead in collecting the remote statistics may be substantial depending on the amount of information being transmitted on the network.
 - Cluster statistics are collected at the specified display refresh rate. Therefore, set the display refresh rate to a reasonable rate based on the number of cluster nodes being collected. The default refresh rate of 3 seconds is reasonable for most remote collection loads.
 - If you specify the Cluster qualifier, the list of cluster nodes applies to any database accessed during the Show Statistics session. When you access additional databases using the Switch Database option, the same cluster nodes are automatically accessed. However, any nodes that you added manually using the Cluster Statistics menu are not automatically added to the new database’s remote collection.

RMU Show Statistics Command

In other words, manually adding and deleting cluster nodes affects only the current database and does not apply to any other database that you may have accessed during the session. For example, when you run the Show Statistics utility on node ALPHA3 with manually added node BONZAI, subsequently switching to BONZAI as the current node will not display cluster statistics from node ALPHA3 unless you manually add that node. Furthermore, switching back to node ALPHA3 as the current node loses the previous collection of node BONZAI because it was manually added.

- Both DECnet and TCP/IP network protocols are supported. By default, the DECnet protocol is used. To explicitly specify which network protocol to use, define the RDM\$BIND_STT_NETWORK_TRANSPORT to DECNET or TCPIP respectively. The RDM\$BIND_STT_NETWORK_TRANSPORT logical name must be defined to the same definition on both the local and cluster nodes. The RDM\$BIND_STT_NETWORK_TRANSPORT logical name can be specified in LNM\$FILE_DEV on the local node but must be specified in the LNM\$SYSTEM_TABLE on all remote nodes.

Note

There is no command qualifier to specify the network protocol.

- The Output qualifier continues to work as usual, but when in cluster mode writes the cluster statistics information to the binary output file.
- The Cluster qualifier cannot be specified with the Input qualifier. Furthermore, the online selection of cluster nodes is not available when you use the Input qualifier.
- While the collection and presentation feature is active, all on-screen menu options continue to operate as usual. This includes the time-plot, scatter-plot, screen pause, and various other options.
- There is no way to exclude the current node from statistics collection. Log in to another node if you want to do this.
- The cluster collection of per-process stall information automatically detects the binding or unbinding of processes to cluster databases. There is no need to manually refresh the database information on the current node.

RMU Show Statistics Command

- If the database is not currently open on the specified node, Oracle RMU still attempts to collect cluster statistics. However, you must open the remote database prior to regular process attaches.
- When you display any of the per-process screens that support cluster statistics collection, such as the Stall Messages screen, you can zoom in on any of the displayed processes to show which node that process is using.
- Using the Cluster Statistics submenu from the Tools menu, it is also possible to collect statistics from all open database nodes using the Collect From Open Database Nodes menu option. This option simplifies the DBA's job of remembering where the database is currently open. However, subsequently opened nodes are not automatically added to the collection; these must be manually added.
- The cluster statistics collection is an intracluster feature in that it works only on the same database, using the same device and directory specification used to run the initial RMU Show Statistics command (that is, on a shared disk). The cluster statistics collection does not work across clusters (intercluster).
- When you replay a binary output file, the screen header region accurately reflects the number of cluster nodes whose statistics are represented in the output file.

Examples

Example 1

The following example directs the results of the RMU Show Statistics command to an output file:

```
$ RMU/SHOW STATISTICS MF_PERSONNEL/OUTPUT=PERS.LOG
```

Example 2

The following example formats the binary results created in the previous example and produces a readable display:

```
$ RMU/SHOW STATISTICS/INPUT=PERS.LOG
```

Example 3

The following DCL script shows a complete example of how to create an excessive stall notification server using the operator notification facility. To execute this script, submit it to any queue on the node from which you want to run the script. Supply the parameters as follows:

RMU Show Statistics Command

- P1 is the database pathname.
- P2 is the completion time.
- P3 is the set of operators to be notified. You must enclose the list of operators in quotes.

```
$ VERIFY = F$VERIFY(0)
$ SET NOON
$!
$! Get the database name.
$!
$ IF P1 .EQS. "" THEN INQUIRE P1 "_database"
$!
$! Get the termination date/time.
$!
$ IF P2 .EQS. "" THEN INQUIRE P2 "_until"
$!
$! Get the operator classes.
$!
$ IF P3 .EQS. "" THEN INQUIRE P3 "_operators"
$!
$ RMU/SHOW STATISTICS/TIME=1/NOBROADCAST -
    /NOINTERACTIVE /UNTIL="'P2'" /ALARM=5 /NOTIFY='P3 -
    'P1
$ VERIFY = F$VERIFY(VERIFY)
$ EXIT
```

Example 4

You can use the `Lock_Timeout` or `Deadlock` qualifiers to construct a Lock Event Logging server. The following OpenVMS DCL script shows how to create a server that logs both lock timeout and lock deadlock events on the `MF_PERSONNEL` database for the next 15 minutes:

```
$ RMU/SHOW STATISTICS /NOHISTOGRAM /TIME=1 /NOINTERACTIVE -
_$ /LOCK_TIMEOUT_LOG=TIMEOUT.LOG /DEADLOCK_LOG=DEADLOCK.LOG -
_$ /NOBROADCAST /UNTIL="+15:00" MF_PERSONNEL
```

Example 5

The following example shows stall log information first with and then without the lock information:

RMU Show Statistics Command

```
$ RMU /SHOW STATISTICS /NOINTERACTIVE /STALL_LOG=SYS$OUTPUT: -
_ $ DUA0:[DB]MFP.RDB
Oracle Rdb X7.1-00 Performance Monitor Stall Log
Database DPA500:[RDB_RANDOM.RDB_RANDOM_TST_247]RNDDDB.RDB;1
Stall Log created 4-SEP-2001 11:27:03.96
11:27:03.96 0002B8A1:1 11:27:03.67 waiting for record 118:2:2 (PR)
State... Process.ID Process.name... Lock.ID. Rq Gr Queue "record 118:2:2"
Blocker: 000220A7 RND_TST_24716 0F019E52 EX Grant
Waiting: 0002B8A1 RND_TST_24715 4500C313 PR Wait
11:27:03.96 0002B8A8:1 11:27:02.32 waiting for record 101:3:0 (EX)
State... Process.ID Process.name... Lock.ID. Rq Gr Queue "record 101:3:0"
Blocker: 000220AD RND_TST_24710 0B00176A PR Grant
Blocker: 000220A7 RND_TST_24716 52018A3F PR Grant
Waiting: 0002B8A8 RND_TST_2474 3C00B5AF EX PR Cnvrt
11:27:03.96 0002B89C:1 11:27:00.15 waiting for record 114:4:1 (PR)
State... Process.ID Process.name... Lock.ID. Rq Gr Queue "record 114:4:1"
Blocker: 000220A7 RND_TST_24716 180033CC EX Grant
Waiting: 0002B89C RND_TST_2479 110066BA PR Wait

$ RMU /SHOW STATISTICS /NOINTERACTIVE /STALL_LOG=SYS$OUTPUT: -
_ $ DUA0:[DB]MFP.RDB /OPTIONS=NOLOG_STALL_LOCK
Oracle Rdb X7.1-00 Performance Monitor Stall Log
Database DPA500:[RDB_RANDOM.RDB_RANDOM_TST_247]RNDDDB.RDB;1
Stall Log created 4-SEP-2001 11:28:34.68
11:28:34.69 0002B8B8:1 11:28:33.69 waiting for logical area 146 (PR)
11:28:34.69 0002B8A8:1 11:28:32.76 waiting for record 114:4:2 (PR)
11:28:34.69 0002B8B3:1 11:28:33.06 waiting for record 114:4:2 (PR)
11:28:34.69 0002B8B0:1 11:28:31.96 waiting for record 111:7:7 (EX)
```

RMU Show System Command

1.61.9 RMU Show System Command

Displays a summary of which databases are in use on a particular node, the monitor log file specification, the number of monitor buffers available, and if after-image journal (AIJ) backup operations have been suspended.

This command is the same as the RMU Show Users command, except that it has no root-file-spec parameter. You can use it to see systemwide user information only.

Format

RMU/Show System

Command Qualifier

/Output[=file-name]

Default

/Output = SYS\$OUTPUT

Description

The RMU Show System command displays information about all active database users on a particular node.

Command Qualifiers

Output[=file-name]

Specifies the name of the file where output will be sent. The default is SYS\$OUTPUT. The default output file extension is .lis, if you specify only a file name without an extension.

Usage Notes

- To use the RMU Show System command, you must have the OpenVMS WORLD privilege.
- When the database monitor is completely idle, identified in the output of the RMU Show Users command by the “no databases accessed on this node” message, the number of available monitor messages should be 1 less than the maximum. During periods of monitor activity, it is normal for the number of available monitor buffers to be less than the maximum, depending on how much work remains for the monitor to process.

RMU Show System Command

Examples

Example 1

The following command lists the file specification for the monitor log file and databases currently in use.

```
$ RMU/SHOW SYSTEM
Oracle Rdb V7.0-64 on node NODEA 27-JUN-2002 16:23:43.92
  - monitor started 26-JUN-2002 06:33:07.33 (uptime 1 09:50:36)
  - monitor log filename is "$111$DUA366:[RDMMON_LOGS]RDMMON701_NODEA.LOG"

database $111$DUA619:[JONES.DATABASES.V70]MF_PERSONNEL.RDB;1
  - first opened 27-JUN-2002 16:23:42.11 (elapsed 0 00:00:01)
  * database is opened by an operator

database NODEB$DKB200:[RDB$TEST_SYSTEM.A70_RMU_4Z.SCRATCH]M_TESTDB.RDB;3
  - first opened 26-JUN-2002 23:24:41.55 (elapsed 0 16:59:02)
  * database is opened by an operator
  * After-image backup operations temporarily suspended from this node
  - current after-image journal file is DISK$RDBTEST8:[RDB$TEST_SYSTEM.A70_RMU_4Z]TEST3.AIJ;2
  - AIJ Log Server is active
  - 1 active database user
```

1.61.10 RMU Show Users Command

Displays information about active database users, the monitor log file specification, the number of monitor buffers available, and if after-image journal (AIJ) backup operations have been suspended. It allows you to see the user activity of specified databases on a specific node, and identifies the various nodes in the VMScluster where the database is currently open and available for use. In addition, if you are using Oracle Rdb for OpenVMS Alpha, this command indicates whether or not system space global sections are enabled.

If you are interested in information on users for a cluster, use the RMU Dump command with the Users qualifier.

Format

RMU/Show Users [root-file-spec]

Command Qualifier

/Output[=file-name]

Default

/Output = SYS\$OUTPUT

Description

The RMU Show Users command displays information about all active database users or users of a particular database, the file specification for the monitor log file, the number of monitor buffers available, and if AIJ backup operations have been suspended.

This command also displays global buffer information for the node on which the RMU Show Users command is issued and displays global buffer information for the specified database only if global buffers are enabled for that database.

Command Parameters

root-file-spec

The root file specification of the database for which you want information. This parameter is optional. If you specify it, only users of that database are shown. Otherwise, all users of all active databases on your current node are shown.

RMU Show Users Command

Command Qualifiers

Output[=file-name]

Specifies the name of the file where output will be sent. The default is SYS\$OUTPUT. The default output file extension is .lis, if you specify a file name.

Usage Notes

- To use the RMU Show Users command for a specified database, you must have the RMU\$SHOW, RMU\$BACKUP, or RMU\$OPEN privilege in the root file access control list (ACL) of the database, or the OpenVMS WORLD privilege.

To use the RMU Show Users command without specifying a database, you must have the RMU\$SHOW, RMU\$BACKUP, or RMU\$OPEN privilege in the root file ACL of the database or databases, and the OpenVMS WORLD privilege.

- When the database monitor is completely idle, identified in the output of the RMU Show Users command by the “no databases accessed on this node” message, the number of available monitor messages should be 1 less than the maximum. During periods of monitor activity, it is normal for the number of available monitor buffers to be less than the maximum, depending on how much work remains for the monitor to process.

Examples

Example 1

The following command lists current users information in the file DBUSE.LIS:

```
$ RMU/SHOW USERS/OUTPUT=DBUSE
```

Example 2

The following example shows all active users:

```
$ RMU/SHOW USER
```

```
Oracle Rdb V7.0-64 on node NODEA 27-JUN-2002 16:25:49.64
- monitor started 26-JUN-2002 06:33:07.33 (uptime 1 09:52:42)
- monitor log filename is "$DISK1:[LOGS]MON701_NODEA.LOG;12"
```

RMU Show Users Command

```
database DISK2:[TEST]M_TESTDB.RDB;3
- first opened 26-JUN-2002 23:24:41.55 (elapsed 0 17:01:08)
* database is opened by an operator
* After-image backup operations temporarily suspended from this node
- current after-image journal file is DISK3:[TEST1]TEST3.AIJ;2
- AIJ Log Server is active
- 1 active database user
- database also open on these nodes:
  NODEB
- 23225948:1 - RDM_4 - non-utility server, USER1 - active user
  - image DISK4:[SYS1.SYSCOMMON.][SYSEXE]RDMALS701.EXE;567
```

RMU Show Version Command

1.61.11 RMU Show Version Command

Displays the currently executing Oracle Rdb software version number and the version of Oracle Rdb required to access the specified database.

Format

RMU/Show Version [root-file-spec]

Command Qualifier

/Output[=file-name]

Default

/Output = SYS\$OUTPUT

Description

This command is useful when you have multiple versions of Oracle Rdb running on your system and perhaps multiple databases. If the currently executing version of Oracle Rdb is not the version required to access the database, change the current version of Oracle Rdb to the required version. See Example 3 in the Examples section.

Command Parameters

root-file-spec

A database root file specification. The default file extension is .rdb. If you do not specify a database root file, RMU Show Version displays only the version of Oracle Rdb under which Oracle RMU is currently running.

Command Qualifiers

Output[=file-name]

Specifies the name of the file where output will be sent. The default is SYS\$OUTPUT. The default output file extension is .lis, if you specify a file name.

RMU Show Version Command

Usage Notes

- You do not need any special privileges to use the RMU Show Version command.
- When the RMU Show Version command executes, it sets the following two DCL local symbols:
 - `RMU$RDB_VERSION`
Set to the currently executing version of Oracle Rdb
 - `RMU$DATABASE_VERSION`
Set to the version of Oracle Rdb required to access the specified database

If you want to set the DCL symbols, `RMU$RDB_VERSION` and `RMU$DATABASE_VERSION`, only and do not want the RMU Show Version output, specify the null device as the file name with the Output qualifier. For example:

```
$ RMU/SHOW VERSION MF_PERSONNEL /OUTPUT=NL:
$ SHOW SYMBOL RMU$RDB_VERSION
  RMU$RDB_VERSION = "7.0"
$ SHOW SYMBOL RMU$DATABASE_VERSION
  RMU$DATABASE_VERSION = "6.1"
```

Examples

Example 1

The following command displays the current version of Oracle Rdb software:

```
$ RMU/SHOW VERSION
Executing RMU for Oracle Rdb V7.0-64
```

Example 2

The following command displays the current version of Oracle Rdb software and the version of Oracle Rdb required to access the `mf_personnel` database:

```
$ RMU/SHOW VERSION MF_PERSONNEL
Executing RMU for Oracle Rdb V7.0-64
Database DISK:[MYDIR]MF_PERSONNEL.RDB;1 requires version 7.0
```

RMU Show Version Command

Example 3

The following example demonstrates how you might use the RMU Show Version command to determine how to access a database that is incompatible with the currently executing version of Oracle Rdb:

```
$ ! The RMU Show Version command tells you that the currently
$ ! executing version of Oracle Rdb is Version 7.0, but
$ ! that mf_personnel requires Version 6.1.
$
$ RMU/SHOW VERSION MF_PERSONNEL
Executing RMU for Oracle Rdb V7.0-00
Database DISK:[MYDIR]MF_PERSONNEL.RDB;1 requires version 6.1
$
$ ! If you ignore this information and attempt to attach to the
$ ! database, you receive an error.
$
$ SQL
SQL> ATTACH 'FILENAME MF_PERSONNEL';
%SQL-F-ERRATTDEC, Error attaching to database MF_PERSONNEL
-RDB-F-WRONG_ODS, the on-disk structure of database filename is
  not supported by version of facility being used
-RDMS-F-ROOTMAJVER, database format 61.0 is not compatible
  with software version 70.0
SQL> EXIT;
$ ! Assign the currently executing version of Oracle Rdb to
$ ! RMU$PREV_VERSION
$ !
$ rmu$prev_version := 'rmu$rdb_version'
$ !
$ ! Use the RDB$SETVER.COM command file to set the version of
$ ! Oracle Rdb to the version required by mf_personnel.
$ ! (For more information on the RDB$SETVER.COM command
$ ! file, see the Oracle Rdb Installation and Configuration Guide.)
$ !
$ @SYS$LIBRARY:RDB$SETVER 'RMU$DATABASE_VERSION'
$ !
$ ! Re-execute the RMU Show Version command to confirm that you have
$ ! the version of Oracle Rdb set correctly.
$ !
$ RMU/SHOW VERSION MF_PERSONNEL
Executing RMU for Oracle Rdb V6.1-00
Database DISK:[MYDIR]MF_PERSONNEL.RDB;1 requires version 6.1
$ ! Invoke SQL and attach to the mf_personnel database.
$ !
$ SQL
SQL>ATTACH 'FILENAME MF_PERSONNEL';
SQL> SHOW TABLES
User tables in database with filename MF_PERSONNEL
      CANDIDATES
      COLLEGES
```

RMU Show Version Command

```
CURRENT_INFO           A view.
CURRENT_JOB            A view.
CURRENT_SALARY         A view.
DEGREES
DEPARTMENTS
EMPLOYEES
JOBS
JOB_HISTORY
RESUMES
SALARY_HISTORY
WORK_STATUS
SQL> EXIT
$ !
$ !Reset the executing version of Oracle Rdb to the original setting.
$ !
$ @SYS$LIBRARY:RDB$SETVER 'RMU$PREV_VERSION'
```

1.62 RMU Unload Command

1.62 RMU Unload Command

Copies the data from a specified table or view of the database into one of the following:

- A specially structured file that contains both the data and the metadata (.unl).
- An RMS file that contains data only (.unl). This file is created when you specify the Record_Definition qualifier. (The Record_Definition qualifier also creates a second file, with file extension .rrd, that contains the metadata.)

Data from the specially structured file can be reloaded by using the RMU Load command only. Data from the RMS file can be reloaded using the RMU Load command or by using an alternative utility such as is offered by DATATRIEVE.

Format

RMU/Unload root-file-spec table-name output-file-name

Command Qualifiers

/Allocation=n
/Buffers=n
/Commit_Every=n
/Delete_Rows
/[No]Error_Delete
/Extend_Quantity=number-blocks
/Fields=(column-name-list)
/Flush={Buffer_End|On_Commit}
/[No]Limit_To=n
/Optimize={options}
/Record_Definition={{[No]File|Path}=name,options}
/Reopen_Count=n
/Row_Count=n
/Statistics_Interval=seconds
/Transaction_Type[=(transaction_mode,options...)]
/[No]Virtual_Fields=[No]Automatic,[No]Computed_By]

Defaults

/Allocation=2048
See description
None
None
See description
/Extend_Quantity=2048
See description
See description
/Nolimit_To
None
See description
See description
See description
/Novirtual_Fields

Description

The RMU Unload command copies data from a specified table or view and places it in a specially structured file or in an RMS file. Be aware that the RMU Unload command does not remove data from the specified table; it merely makes a copy of the data.

1.62 RMU Unload Command

The RMU Unload command can be used to do the following:

- Extract data for an application that cannot access the Oracle Rdb database directly.
- Create an archival copy of data.
- Perform restructuring operations.
- Sort data by defining a view with a sorted-by clause, then unloading that view.

The specially structured files created by the RMU Unload command contain metadata for the table that was unloaded. The RMS files created by the RMU Unload command contain only data; the metadata can be found either in the data dictionary or in the .rrd file created using the Record_Definition qualifier. Specify the Record_Definition qualifier to exchange data with an application that uses RMS files.

The LIST OF BYTE VARYING (segmented string) data type cannot be unloaded into an RMS file; however, it can be unloaded into the specially structured file type.

Data type conversions are valid only if Oracle Rdb supports the conversion.

The RMU Unload command executes a read-only transaction to gather the metadata and user data to be unloaded. It is compatible with all operations that do not require exclusive access.

Command Parameters

root-file-spec

The root file specification of the database from which tables or views will be unloaded. The default file extension is .rdb.

table-name

The name of the table or view to be unloaded, or its synonym.

output-file-name

The destination file name. The default file extension is .unl.

Command Qualifiers

Allocation=n

Enables you to preallocate the generated output file. The default allocation is 2048 blocks; when the file is closed it is truncated to the actual length used.

1.62 RMU Unload Command

If the value specified for the Allocation qualifier is less than 65535, it becomes the new maximum for the Extend_Quantity qualifier.

Buffers=n

Specifies the number of database buffers used for the unload operation. If no value is specified, the default value for the database is used. Although this qualifier might affect the performance of the unload operation, the default number of buffers for the database usually allows adequate performance.

Commit_Every=n

Turns the selection query into a WITH HOLD cursor so that the data stream is not closed by a commit. Refer to the *Oracle Rdb7 SQL Reference Manual* for more information about the WITH HOLD clause.

Delete_Rows

Specifies that Oracle Rdb delete rows after they have been unloaded from the database. You can use this qualifier with the Commit_Every qualifier to process small batches of rows.

If constraints, triggers, or table protection prevent the deletion of rows, the RMU Unload operation will fail. The Delete_Rows qualifier cannot be used with non-updatable views, those containing joins, or aggregates (union or group by).

Error_Delete

Noerror_Delete

Specifies whether the unload and record definition files should be deleted on error. By default, the RMU Unload command deletes the unload and record definition files if an unrecoverable error occurs that causes an abnormal termination of the unload command execution. Use the Noerror_Delete qualifier to retain the files.

If the Delete_Rows qualifier is specified, the default for this qualifier is Noerror_Delete. This default is necessary to allow you to use the unload and record definition files to reload the data if an unrecoverable error has occurred after the delete of some of the unloaded rows has been committed. Even if the unload file is retained, it may not be able to reload the data using the RMU Load command if the error is severe enough to prevent the RMU error handler from continuing to access the unload file once the error is detected.

If the Delete_Rows qualifier is not specified, the default is Error_Delete.

1.62 RMU Unload Command

Extend_Quantity=number-blocks

Sets the size, in blocks, by which the unload file (.unl) can be extended. The minimum value for the number-blocks parameter is 1; the maximum value is 65535. If you provide a value for the Allocation qualifier that is less than 65535, that value becomes the maximum you can specify.

If you do not specify the Extend_Quantity qualifier, the default block size by which .unl files can be extended is 2048 blocks.

Fields=(column-name-list)

Specifies the column or columns of the table or view to be unloaded from the database. If you list multiple columns, separate the column names with a comma, and enclose the list of column names within parentheses. This qualifier also specifies the order in which the columns should be unloaded if that order differs from what is defined for the table or view. Changing the structure of the table or view could be useful when restructuring a database or when migrating data between two databases with different metadata definitions. The default is all the columns defined for the table or view in the order defined.

Flush={Buffer_End | On_Commit}

Controls when internal RMS buffers are flushed to the unload file. By default, the RMU Unload command flushes any data left in the internal RMS file buffers only when the unload file is closed. The Flush qualifier changes that behavior. You must use one of the following options with the Flush qualifier:

- Buffer_End

The Buffer_End option specifies that the internal RMS buffers be flushed to the unload file after each unload buffer has been written to the unload file.

- On_Commit

The On_Commit option specifies that the internal RMS buffers be flushed to the unload file just before the current unload transaction is committed.

If the Delete_Rows qualifier is specified, the default for this qualifier is Flush=On_Commit. This default is necessary to allow you to use the unload and record definition files to reload the data if an unrecoverable error has occurred after the delete of some of the unloaded rows has been committed.

If the Delete_Rows qualifier is not specified, the default is to flush the record definition buffers only when the unload files are closed.

1.62 RMU Unload Command

More frequent flushing of the internal RMS buffers will avoid the possible loss of some unload file data if an error occurs and the `Noerror_Delete` qualifer has been specified. Additional flushing of the RMS internal buffers to the unload file can cause the RMU Unload command to take longer to complete.

Limit_To=n

Nolimit_To

Limits the number of rows unloaded from a table or view. The primary use of the `Limit_To` qualifier is to unload a data sample for loading into test databases. The default is the `Nolimit_To` qualifier.

Optimize={options}

Controls the query optimization of the RMU Unload command. You must use one or more of the following options with the `Optimize` qualifier:

- `Conformance={Optional | Mandatory}`

This option accepts two keywords, `Optional` or `Mandatory`, which can be used to override the settings in the specified query outline.

If the matching query outline is invalid, the `Conformance=Mandatory` option causes the query compile, and hence the RMU Unload operation, to stop. The query outline will be one which either matches the string provided by the `Using_Outline` or `Name_As` option or matches the query identification.

The default behavior is to use the setting within the query outline. If no query outline is found, or query outline usage is disabled, then this option is ignored.
- `Fast_First`

This option asks the query optimizer to favor strategies that return the first rows quickly, possibly at the expense of longer overall retrieval time. This option does not override the setting if any query outline is used.

This option cannot be specified at the same time as the `Total_Time` option.

Note

Oracle Corporation does not recommend this optimization option for the RMU Unload process. It is provided only for backward compatibility with prior Rdb releases when it was the default behavior.

- `Name_As=query_name`

1.62 RMU Unload Command

This option supplies the name of the query. It is used to annotate output from the Rdb debug flags (enabled using the logical `RDMS$SET_FLAGS`) and is also logged by Oracle TRACE.

If the `Using_Outline` option is not used, this name is also used as the query outline name.

- `Selectivity=selectivity-value`

This option allows you to influence the Oracle Rdb query optimizer to use different selectivity values.

The `Selectivity` option accepts the following keywords:

- `Aggressive` — assumes a smaller number of rows is selected compared to the default Oracle Rdb selectivity
- `Sampled` — uses literals in the query to perform preliminary estimation on indices
- `Default` — uses default selectivity rules

The following example shows a use of the `Selectivity` option:

```
$RMU/UNLOAD/OPTIMIZE=(TOTAL_TIME, SELECTIVITY=SAMPLED) -  
_$_ SALES_DB CUSTOMER_TOP10 TOP10.UNL
```

This option is most useful when the RMU Unload command references a view definition with a complex predicate.

- `Sequential_Access`

This option requests that index access be disabled for this query. This is particularly useful for RMU Unload from views against strictly partitioned tables. Strict partitioning is enabled by the `PARTITIONING IS NOT UPDATABLE` clause on the `CREATE` or `ALTER STORAGE MAP` statements. Retrieval queries only use this type of partition optimization during sequential table access.

This option cannot be specified at the same time as the `Using_Outline` option.

- `Total_Time`

This option requests that total time optimization be applied to the unload query. It does not override the setting if any query outline is used.

In some cases, total time optimization may improve performance of the RMU Unload command when the query optimizer favors overall performance instead of faster retrieval of the first row. Since the RMU Unload process is unloading the entire set, there is no need to require fast delivery of the first few rows.

1.62 RMU Unload Command

This option may not be specified at the same time as the `Fast_First` option. The `Optimize=Total_Time` behavior is the default behavior for the RMU Unload command if the `Optimize` qualifier is not specified.

- `Using_Outline=outline_name`

This option supplies the name of the query outline to be used by the RMU Unload command. If the query outline does not exist, the name is ignored.

This option may not be specified at the same time as the `Sequential_Access` option.

Record_Definition={{[No]File | Path}=name,options}

Creates an RMS file containing the record structure definition for the output file. The record description uses the CDO record and field definition format. The default file extension is `.rrd`.

If you omit the `File=name` or `Path=name` option you must specify an option.

The date-time syntax in `.rrd` files generated by this qualifier changed in Oracle Rdb V6.0 to make the `.rrd` file compatible with the date-time syntax support for Oracle CDD/Repository V6.1. The RMU Unload command accepts both the date-time syntax generated by the `Record_Definition` qualifier in previous versions of Oracle Rdb and the syntax generated in Oracle Rdb V6.0 and later.

See Appendix A for more information on `.rrd` files and details on the date-time syntax generated by this qualifier.

The options are:

- `Format=(Text)`

If you specify the `Format=(Text)` option, Oracle RMU converts all data to printable text before unloading it.

- `Format=XML`

The `Format=XML` option causes the output `Record_Definition` file type to default to `.DTD` (Document Type Definition). The output file defaults to type `.XML`. The contents of the data file is in XML format suitable for processing with a Web browser or XML application.

If you use the `Nofile` option or do not specify the `File` or `Path` keyword, the DTD is included in the XML output file (internal DTD). If you specify a name with the `File` or `Path` keyword to identify an output file, the file is referenced as an external DTD from within the XML file.

1.62 RMU Unload Command

The XML file contains a single table that has the name of the database and multiple rows named <RMU_ROW>. Each row contains the values for each column in printable text. If a value is NULL, then the tag <NULL/> is displayed. Example 16 shows this behavior.

Note

The RMU Load command does not support loading data using FORMAT:XML.

- Format=(Delimited_Text [,delimiter-options])

If you specify the Format=Delimited_Text option, Oracle RMU applies delimiters to all data before unloading it.

Note that DATE VMS dates are output in the collatable time format, which is *yyyymmddhhmmsscc*. For example, March 20, 1993 is output as: 1993032000000000.

If the Format option is not used, Oracle RMU outputs data to a fixed-length binary flat file. If the Format=Delimited_Text options is not used, VARCHAR(n) strings are padded with blanks when the specified string has fewer characters than *n* so that the resulting string is *n* characters long.

Delimiter options (and their default values if you do not specify delimiter options) are:

- Prefix=string
Specifies a prefix string that begins any column value in the ASCII output file. If you omit this option, the column prefix will be a quotation mark (").
- Separator=string
Specifies a string that separates column values of a row. If you omit this option, the column separator will be a single comma (,).
- Suffix=string
Specifies a suffix string that ends any column value in the ASCII output file. If you omit this option, the column suffix will be a quotation mark (").
- Terminator=string
Specifies the row terminator that completes all the column values corresponding to a row. If you omit this option, the row terminator will be the end of the line.

1.62 RMU Unload Command

– Null=string

Specifies a string, which when found in the database column, is unloaded as NULL in the output file.

The Null option can be specified on the command line as any one of the following:

- * A quoted string
- * An empty set of double quotes (" ")
- * No string

The string that represents the null character must be quoted on the Oracle RMU command line. You cannot specify a blank space or spaces as the null character. You cannot use the same character for the Null value and other Delimited_Text options.

Note

The values of each of the strings specified in the delimiter options must be enclosed within quotation marks. Oracle RMU strips these quotation marks while interpreting the values. If you want to specify a quotation mark (") as a delimiter, specify a string of four quotation marks. Oracle RMU interprets four quotation marks as your request to use one quotation mark as a delimiter. For example, Suffix = " " " " .

Oracle RMU reads these quotation marks as follows:

- The first quotation mark is stripped from the string.
- The second and third quotation mark are interpreted as your request for one quotation mark (") as a delimiter.
- The fourth quotation mark is stripped.

This results in one quotation mark being used as a delimiter.

Furthermore, if you want to specify a quotation mark as part of the delimited string, you must use two quotation marks for each quotation mark that you want to appear in the string. For example, Suffix = " * * " " * * " causes Oracle RMU to use a delimiter of * * * * .

-
- Trim=option

1.62 RMU Unload Command

If you specify the Trim=option keyword, leading and/or trailing spaces area removed from each output field. Option supports three keywords:

- **TRAILING** - trailing spaces will be trimmed from CHARACTER and CHARACTER VARYING (VARCHAR) data that is unloaded. This is the default setting if only the TRIM option is specified.
- **LEADING** - leading spaces will be trimmed from CHARACTER and CHARACTER VARYING (VARCHAR) data that is unloaded.
- **BOTH** - both leading and trailing spaces will be trimmed.

When the Record_Definition qualifier is used with load or unload operations, and the Null option to the Delimited_Text option is not specified, any null values stored in the rows of the tables being loaded or unloaded are not preserved. Therefore, if you want to preserve null values stored in tables and you are moving data within the database or between databases, specify the Null option with Delimited_Text option of the Record_Definition qualifier.

Reopen_Count=n

The Reopen_Count=n qualifier allows you to specify how many records are written to an output file. The output file will be re-created (that is, a new version of the file will be created) when the record count reaches the specified value. The Reopen_Count=n qualifier is only valid when used with the Record_Definition or Rms_Record_Def qualifiers.

Rms_Record_Def=({File | Path}=name [,options])

Synonymous with the Record_Definition qualifier. See the description of the Record_Definition qualifier.

Row_Count=n

Specifies that Oracle Rdb buffer multiple rows between the Oracle Rdb server and the RMU Unload process. The default value for *n* is 500 rows; however, this value should be adjusted based on working set size and length of unloaded data. Increasing the row count may reduce the CPU cost of the unload operation. For remote databases, this may significantly reduce network traffic for large volumes of data because the buffered data can be packaged into larger network packets.

The minimum value you can specify for *n* is 1. The default row size is the value specified for the Commit_Every qualifier or 500, whichever is smaller.

Statistics_Interval=seconds

Specifies that statistics are to be displayed at regular intervals so that you can evaluate the progress of the unload operation.

1.62 RMU Unload Command

The displayed statistics include:

- Elapsed time
- CPU time
- Buffered I/O
- Direct I/O
- Page faults
- Number of records unloaded since the last transaction was committed
- Number of records unloaded so far in the current transaction

If the `Statistics_Interval` qualifier is specified, the `seconds` parameter is required. The minimum value is 1. If the unload operation completes successfully before the first time interval has passed, you receive only an informational message on the number of files unloaded. If the unload operation is unsuccessful before the first time interval has passed, you receive error messages and statistics on the number of records unloaded.

At any time during the unload operation, you can press `Ctrl/T` to display the current statistics.

Transaction_Type[=(transaction_mode,options,...)]

Allows you to specify the transaction mode, isolation level, and wait behavior for transactions.

Use one of the following keywords to control the transaction mode:

- **Automatic**
When `Transaction_Type=Automatic` is specified, the transaction type depends on the current database settings for snapshots (enabled, deferred, or disabled), transaction modes available to this user, and the standby status of the database. Automatic mode is the default.
- **Read_Only**
Starts a `Read_Only` transaction.
- **Exclusive**
Starts a `Read_Write` transaction and reserves the table for `Exclusive_Read`.
- **Protected**
Starts a `Read_Write` transaction and reserves the table for `Protected_Read`.
- **Shared**

1.62 RMU Unload Command

Starts a Read_Write transaction and reserves the table for Shared_Read.

Use one of the following options with the keyword `Isolation_Level=[option]` to specify the transaction isolation level:

- `Read_Committed`
- `Repeatable_Read`
- `Serializable`. `Serializable` is the default setting.

Refer to the `SET TRANSACTION` statement in the Oracle Rdb SQL Reference Manual for a complete description of the transaction isolation levels.

Specify the wait setting by using one of the following keywords:

- `Wait`
Waits indefinitely for a locked resource to become available. `Wait` is the default behavior.
- `Wait=n`
The value you supply for *n* is the transaction lock timeout interval. When you supply this value, Oracle Rdb waits *n* seconds before aborting the wait and the RMU Unload session. Specifying a wait timeout interval of zero is equivalent to specifying `Nowait`.
- `Nowait`
Does not wait for a locked resource to become available.

Virtual_Fields=[No]Automatic,[No]Computed_By]

Novirtual_Fields

The `Virtual_Fields` qualifier unloads any `AUTOMATIC` or `COMPUTED BY` fields as real data. This qualifier permits the transfer of computed values to another application. It also permits unloading through a view that is a union of tables or that is comprised of columns from multiple tables. For example, if there are two tables, `EMPLOYEES` and `RETIRED_EMPLOYEES`, the view `ALL_EMPLOYEES` (a union of `EMPLOYEES` and `RETIRED_EMPLOYEES` tables) can be unloaded.

The `Novirtual_Fields` qualifier is the default, which is equivalent to the `Virtual_Fields=[Noautomatic,Nowcomputed_By]` qualifier.

If you specify the `Virtual_Fields` qualifier without a keyword, all fields are unloaded, including `COMPUTED BY` and `AUTOMATIC` table columns, and calculated `VIEW` columns.

1.62 RMU Unload Command

If you specify the `Virtual_Fields=(Automatic,Nocomputed_By)` qualifier or the `Virtual_Fields=Nocomputed_By` qualifier, data is only unloaded from Automatic fields. If you specify the `Virtual_Fields=(Noautomatic,Computed_By)` qualifier or the `Virtual_Fields=Noautomatic` qualifier, data is only unloaded from Computed_By fields.

Usage Notes

- To use the RMU Unload command for a database, you must have the `RMU$UNLOAD` privilege in the root file access control list (ACL) for the database or the OpenVMS `SYSPRV` or `BYPASS` privilege. You must also have the SQL `SELECT` privilege to the table or view being unloaded.
- For tutorial information on the RMU Unload command, refer to the *Oracle Rdb Guide to Database Design and Definition*.
- Detected asynchronous prefetch should be enabled to achieve the best performance of this command. Beginning with Oracle Rdb V7.0, by default, detected asynchronous prefetch is enabled. You can determine the setting for your database by issuing the RMU Dump command with the Header qualifier.

If detected asynchronous prefetch is disabled, and you do not want to enable it for the database, you can enable it for your Oracle RMU operations by defining the following logicals at the process level:

```
$ DEFINE RDM$BIND_DAPF_ENABLED 1
$ DEFINE RDM$BIND_DAPF_DEPTH_BUF_CNT P1
```

P1 is a value between 10 and 20 percent of the user buffer count.

- You can unload a table from a database structured under one version of Oracle Rdb and load it into the same table of a database structured under another version of Oracle Rdb. For example, if you unload the `EMPLOYEES` table from a `mf_personnel` database created under Oracle Rdb V6.0, you can load the generated `.unl` file into an Oracle Rdb V7.0 database. Likewise, if you unload the `EMPLOYEES` table from a `mf_personnel` database created under Oracle Rdb V7.0, you can load the generated `.unl` file into an Oracle Rdb V6.1 database. This is true even for specially formatted binary files (created with the RMU Unload command without the `Record_Definition` qualifier). The earliest version into which you can load a `.unl` file from another version is Oracle Rdb V6.0.

1.62 RMU Unload Command

- The Fields qualifier can be used with indirect file references. When you use the Fields qualifier with an indirect file reference in the field list, the referenced file is written to SYS\$OUTPUT if you have used the DCL SET VERIFY command. See Section 1.3 for more information.
- To view the contents of the specially structured .unl file created by the RMU Unload command, use the RMU Dump Export command.
- To preserve the null indicator in a load or unload operation, use the Null option with the Record_Definition qualifier. Using the Record_Definition qualifier without the Null option replaces all null values with zeros; this can cause unexpected results with computed-by columns.
- Oracle RMU does not allow you to unload a system table.
- The RMU Unload command recognizes character set information. When you unload a table, RMU Unload transfers information about the character set to the record definition file.
- When it creates the record definition file, the RMU Unload command preserves any lowercase characters in table and column names by allowing delimited identifiers. **Delimited identifiers** are user-supplied names enclosed within quotation marks (" ").

By default, RMU Unload changes any table or column (field) names that you specify to uppercase. To preserve lowercase characters, use delimited identifiers. That is, enclose the names within quotation marks. In the following example, RMU Unload preserves the uppercase and lowercase characters in "Last_Name" and "Employees":

```
$ RMU/UNLOAD/FIELDS=("Last_name",FIRST_NAME) TEST "Employees" TEST.UNL
```

Note

The data dictionary does not preserve the distinction between uppercase and lowercase identifiers. If you use delimited identifiers, you must be careful to ensure that the record definition does not include objects with names that are duplicates except for the case. For example, the data dictionary considers the delimited identifiers "Employee_ID" and "EMPLOYEE_ID" to be the same name.

- Oracle RMU does not support the multischema naming convention and returns an error if you specify one. For example:

1.62 RMU Unload Command

```
$ RMU/UNLOAD CORPORATE_DATA ADMINISTRATION.PERSONNEL.EMPLOYEES -
_$_$ OUTPUT.UNL
%RMU-E-OUTFILDEL, Fatal error, output file deleted
-RMU-F-RELNOTFND, Relation (ADMINISTRATION.PERSONNEL.EMPLOYEES) not found
```

When using a multischema database, you must specify the SQL stored name for the database object.

For example, to find the stored name that corresponds to the ADMINISTRATION.PERSONNEL.EMPLOYEES table in the corporate_data database, issue an SQL SHOW TABLE command, as follows:

```
SQL> SHOW TABLE ADMINISTRATION.PERSONNEL.EMPLOYEES
Information for table ADMINISTRATION.PERSONNEL.EMPLOYEES
  Stored name is EMPLOYEES
  .
  .
  .
```

Then to unload the table, issue the following RMU Unload command:

```
$ RMU/UNLOAD CORPORATE_DATA EMPLOYEES OUTPUT.UNL
```

- If the Transaction_Type qualifier is omitted, a Read_Only transaction is started against the database. This behavior is provided for backward compatibility with prior Rdb releases. If the Transaction_Type qualifier is specified without a transaction mode, the default value Automatic is used.
- If the database has snapshots disabled, Oracle Rdb defaults to a READ WRITE ISOLATION LEVEL SERIALIZABLE transaction. Locking may be reduced by specifying Transaction_Type=(Automatic), or Transaction_Type=(Shared,Isolation_Level=Read_Committed).
- If you use a synonym to represent a table or a view, the RMU Unload command translates the synonym to the base object and processes the data as though the base table or view had been named. This implies that the unload interchange files (.UNL) or record definition files (.RRD) that contain the table metadata will name the base table or view and not use the synonym name. If the metadata is used against a different database, you may need to use the Match_Name qualifier to override this name during the RMU load process.

1.62 RMU Unload Command

Examples

Example 1

The following command unloads the `EMPLOYEE_ID` and `LAST_NAME` column values from the `EMPLOYEES` table of the `mf_personnel` database. The data is stored in `names.unl`.

```
$ RMU/UNLOAD -
_ $ /FIELDS=(EMPLOYEE_ID, LAST_NAME) -
_ $ MF_PERSONNEL EMPLOYEES NAMES.UNL
%RMU-I-DATRECUNL, 100 data records unloaded.
```

Example 2

The following command unloads the `EMPLOYEES` table from the `mf_personnel` database and places the data in the RMS file, `names.unl`. The `names.rrd` file contains the record structure definitions for the data in `names.unl`.

```
$ RMU/UNLOAD/RECORD_DEFINITION=FILE=NAMES.RRD MF_PERSONNEL -
_ $ EMPLOYEES NAMES.UNL
%RMU-I-DATRECUNL, 100 data records unloaded.
```

Example 3

The following command unloads the `EMPLOYEE_ID` and `LAST_NAME` column values from the `EMPLOYEES` table of the `mf_personnel` database and accepts the default values for delimiters, as shown by viewing the `names.unl` file:

```
$ RMU/UNLOAD/FIELDS=(EMPLOYEE_ID, LAST_NAME) -
- $ /RECORD_DEFINITION=(FILE=NAMES, FORMAT=DELIMITED_TEXT) -
- $ MF_PERSONNEL EMPLOYEES NAMES.UNL
%RMU-I-DATRECUNL, 100 data records unloaded.
$ !
$ ! TYPE the names.unl file to see the effect of the RMU Unload
$ ! command.
$ !
$ TYPE NAMES.UNL

"00164", "Toliver      "
"00165", "Smith        "
"00166", "Dietrich    "
"00167", "Kilpatrick  "
"00168", "Nash        "
.
.
.
```

Example 4

1.62 RMU Unload Command

The following command unloads the `EMPLOYEE_ID` and `LAST_NAME` column values from the `EMPLOYEES` table of the `mf_personnel` database and specifies the asterisk (*) character as the string to mark the beginning and end of each column (the prefix and suffix string):

```
$ RMU/UNLOAD/FIELDS=(EMPLOYEE_ID, LAST_NAME) -
_ $ /RECORD_DEFINITION=(FILE=NAMES, -
_ $ FORMAT=DELIMITED_TEXT, SUFFIX="*", -
_ $ PREFIX="*") -
_ $ MF_PERSONNEL EMPLOYEES NAMES.UNL
%RMU-I-DATRECUNL, 100 data records unloaded.
$ !
$ ! TYPE the names.unl file to see the effect of the RMU Unload
$ ! command.
$ !
$ TYPE NAMES.UNL
*00164*,*Toliver      *
*00165*,*Smith       *
*00166*,*Dietrich    *
*00167*,*Kilpatrick  *
*00168*,*Nash        *
*00169*,*Gray        *
*00170*,*Wood        *
*00171*,*D'Amico     *
.
.
.
```

Example 5

The following command unloads all column values from the `EMPLOYEES` table of the `mf_personnel` database, and specifies the `Format=Text` option of the `Record_Definition` qualifier. Oracle RMU will convert all the data to printable text, as can be seen by viewing the `text_output.unl` file:

```
$ RMU/UNLOAD/RECORD_DEFINITION=(FILE=TEXT_RECORD,FORMAT=TEXT) -
_ $ MF_PERSONNEL EMPLOYEES TEXT_OUTPUT
%RMU-I-DATRECUNL, 100 data records unloaded.
$ !
$ ! TYPE the text_output.unl file to see the effect of the RMU Unload
$ ! command.
$ !
```

1.62 RMU Unload Command

```
$ TYPE TEXT_OUTPUT.UNL
00164Toliver      Alvin      A146 Parnell Place
Chocorua          NH03817M19470328000000001
00165Smith       Terry      D120 Tenby Dr.
Chocorua          NH03817M19540515000000002
00166Dietrich    Rick       19 Union Square
Boscawen         NH03301M19540320000000001
.
.
.
```

Example 6

The following command unloads the `EMPLOYEE_ID` and `LAST_NAME` column values from the `EMPLOYEES` table of the `mf_personnel` database and requests that statistics be displayed on the terminal at 2-second intervals:

```
$ RMU/UNLOAD/FIELDS=(EMPLOYEE_ID, LAST_NAME) -
_$_ /STATISTICS_INTERVAL=2 -
_$_ MF_PERSONNEL EMPLOYEES NAMES.UNL

-----
ELAPSED:0 00:00:02.16 CPU: 0:00:00.26 BUFIO: 13 DIRIO: 57 FAULTS: 598
  0 records unloaded.
-----
ELAPSED:0 00:00:04.32 CPU: 0:00:00.68 BUFIO: 18 DIRIO: 102 FAULTS: 2121
  0 records unloaded.
-----
ELAPSED:0 00:00:06.32 CPU: 0:00:00.92 BUFIO: 31 DIRIO: 158 FAULTS: 2483
  39 records unloaded.
-----
%RMU-I-DATRECUNL, 100 data records unloaded.
$
```

Example 7

The following example unloads a subset of data from the `EMPLOYEES` table, using the following steps:

1. Create a temporary view on the `EMPLOYEES` table that includes only employees who live in Massachusetts.
2. Use an RMU Unload command to unload the data from this view.

1.62 RMU Unload Command

3. Delete the temporary view.

```
$ SQL
SQL> ATTACH 'FILENAME MF_PERSONNEL';
SQL> CREATE VIEW MA_EMPLOYEES
cont> (EMPLOYEE_ID,
cont>     LAST_NAME,
cont>     FIRST_NAME,
cont>     MIDDLE_INITIAL,
cont>     STATE,
cont>     STATUS_CODE)
cont> AS SELECT
cont>     E.EMPLOYEE_ID,
cont>     E.LAST_NAME,
cont>     E.FIRST_NAME,
cont>     E.MIDDLE_INITIAL,
cont>     E.STATE,
cont>     E.STATUS_CODE
cont> FROM EMPLOYEES E
cont> WHERE E.STATE='MA';
SQL> COMMIT;
SQL> EXIT;

$ RMU/UNLOAD/RECORD_DEFINITION=(FILE=MA_EMPLOYEES,FORMAT=DELIMITED_TEXT) -
_$ MF_PERSONNEL MA_EMPLOYEES MA_EMPLOYEES.UNL
%RMU-I-DATRECUNL, 9 data records unloaded.

$ SQL
SQL> ATTACH 'FILENAME MF_PERSONNEL';
SQL> DROP VIEW MA_EMPLOYEES;
SQL> COMMIT;
```

Example 8

The following example shows that null values in blank columns are not preserved unless the Null option is specified with the Delimited_Text option of the Record_Definition qualifier:

```
$ SQL
SQL> ATTACH 'FILENAME MF_PERSONNEL';
SQL> --
SQL> -- Create the NULL_DATE table:
SQL> CREATE TABLE NULL_DATE
cont> (COL1 VARCHAR(5),
cont>  DATE1 DATE,
cont>  COL2 VARCHAR(5));
SQL> --
SQL> -- Store a row that does not include a value for the DATE1
SQL> -- column of the NULL_DATE table:
SQL> INSERT INTO NULL_DATE
cont>     (COL1, COL2)
cont> VALUES ('first', 'last');
1 row inserted
SQL> --
```

1.62 RMU Unload Command

```
SQL> COMMIT;
SQL> --
SQL> -- The previous SQL INSERT statement causes a null value to
SQL> -- be stored in NULL_DATE:
SQL> SELECT * FROM NULL_DATE;
   COL1   DATE1                COL2
   ----   ----                ----
   first  NULL                  last
1 row selected
SQL> --
SQL> DISCONNECT DEFAULT;
SQL> EXIT;
$ !
$ ! In the following RMU Unload command, the Record_Definition
$ ! qualifier is used to unload the row with the NULL value, but
$ ! the Null option is not specified:
$ RMU/UNLOAD/RECORD_DEFINITION=(FILE=NULL_DATE,FORMAT=DELIMITED_TEXT) -
_$ MF_PERSONNEL NULL_DATE NULL_DATE
%RMU-I-DATRECUNL, 1 data records unloaded.
$ !
$ ! The null_date.unl file created by the previous unload
$ ! operation does not preserve the NULL value in the DATE1 column.
$ ! Instead, the Oracle Rdb default date value is used:
$ TYPE NULL_DATE.UNL
"first","1858111700000000","last"
$ !
$ ! This time, unload the row in NULL_DATE with the Null option to
$ ! the Record_Definition qualifier:
$ RMU/UNLOAD MF_PERSONNEL NULL_DATE NULL_DATE -
_$ /RECORD_DEFINITION=(FILE=NULL_DATE.RRD, FORMAT=DELIMITED_TEXT, NULL="*")
%RMU-I-DATRECUNL, 1 data records unloaded.
$ !
$ TYPE NULL_DATE.UNL
"first",*,"last "
$ SQL
SQL> ATTACH 'FILENAME MF_PERSONNEL';
SQL> --
SQL> -- Delete the existing row from NULL_DATE:
SQL> DELETE FROM NULL_DATE;
1 row deleted
SQL> --
SQL> COMMIT;
SQL> EXIT;
$ !
$ ! Load the row that was unloaded back into the table,
$ ! using the null_date.unl file created by the
$ ! previous RMU Unload command:
$ RMU/LOAD MF_PERSONNEL /RECORD_DEFINITION=(FILE=NULL_DATE.RRD, -
_$ FORMAT=DELIMITED_TEXT, NULL="*") NULL_DATE NULL_DATE
%RMU-I-DATRECREAD, 1 data records read from input file.
%RMU-I-DATRECSTO, 1 data records stored.
```

1.62 RMU Unload Command

```
$ !
$ SQL
SQL> ATTACH 'FILENAME MF_PERSONNEL';
SQL> --
SQL> -- Display the row stored in NULL_DATE.
SQL> -- The NULL value stored in the data row
SQL> -- was preserved by the load and unload operations:
SQL> SELECT * FROM NULL_DATE;
  COL1    DATE1                COL2
  first  NULL                  last
1 row selected
```

Example 9

The following example demonstrates the use of the Null="" option of the Record_Definition qualifier to signal to Oracle RMU that any data that is an empty string in the .unl file (as represented by two commas with no space separating them) should have the corresponding column in the database flagged as NULL.

The first part of this example shows the contents of the .unl file and the RMU Load command used to load the .unl file. The terminator for each record in the .unl file is the number sign (#). The second part of this example unloads the data and specifies that any columns that are flagged as NULL should be represented in the output file with an asterisk.

```
"90021", "ABUSHAKRA", "CAROLINE", "A", "5 CIRCLE STREET", ,
"CHELMSFORD", "MA", "02184", "1960061400000000"#
"90015", "BRADFORD", "LEO", "B", "4 PLACE STREET", , "NASHUA", "NH",
"03030", "1949051800000000"#
$ !
$ RMU/LOAD/FIELDS=(EMPLOYEE_ID, LAST_NAME, FIRST_NAME, -
_ $ MIDDLE_INITIAL, ADDRESS_DATA_1, ADDRESS_DATA_2, -
_ $ CITY, STATE, POSTAL_CODE, BIRTHDAY) -
_ $ /RECORD_DEFINITION=(FILE= EMPLOYEES.RRD, -
_ $ FORMAT=DELIMITED_TEXT, -
_ $ TERMINATOR="#", -
_ $ NULL="") -
_ $ MF_PERSONNEL EMPLOYEES EMPLOYEES.UNL
%RMU-I-DATRECREAD, 2 data records read from input file.
%RMU-I-DATRECSTO, 2 data records stored.
```

1.62 RMU Unload Command

```
$ !
$ ! Unload this data first without specifying the Null option:
$ RMU/UNLOAD/FIELDS=(EMPLOYEE_ID, LAST_NAME, FIRST_NAME, -
_ $ MIDDLE_INITIAL, ADDRESS_DATA_1, ADDRESS_DATA_2, -
_ $ CITY, STATE, POSTAL_CODE, BIRTHDAY) -
_ $ /RECORD_DEFINITION=(FILE= EMPLOYEES.RRD, -
_ $ FORMAT=DELIMITED_TEXT, -
_ $ TERMINATOR="#" ) -
_ $ MF_PERSONNEL EMPLOYEES EMPLOYEES.UNL
%RMU-I-DATRECUNL, 102 data records unloaded.
$ !
$ ! The ADDRESS_DATA_2 field appears as a quoted string:
$ TYPE EMPLOYEES.UNL
.
.
.
"90021", "ABUSHAKRA      ", "CAROLINE ", "A", "5 CIRCLE STREET      ", "
      ", "CHELMSFORD      ", "MA", "02184", "1960061400000000"#
$ !
$ ! Now unload the data with the Null option specified:
$ RMU/UNLOAD/FIELDS=(EMPLOYEE_ID, LAST_NAME, FIRST_NAME, -
_ $ MIDDLE_INITIAL, ADDRESS_DATA_1, ADDRESS_DATA_2, -
_ $ CITY, STATE, POSTAL_CODE, BIRTHDAY) -
_ $ /RECORD_DEFINITION=(FILE= EMPLOYEES.RRD, -
_ $ FORMAT=DELIMITED_TEXT, -
_ $ TERMINATOR="##", -
_ $ NULL="*") -
_ $ MF_PERSONNEL EMPLOYEES EMPLOYEES.UNL
%RMU-I-DATRECUNL, 102 data records unloaded.
$ !
$ ! The value for ADDRESS_DATA_2 appears as an asterisk:
$ !
$ TYPE EMPLOYEES.UNL
.
.
.
"90021", "ABUSHAKRA      ", "CAROLINE ", "A", "5 CIRCLE STREET      ", *,
"CHELMSFORD      ", "MA", "02184", "1960061400000000"#
```

Example 10

The following example specifies a transaction for the RMU Unload command equivalent to the SQL command **SET TRANSACTION READ WRITE WAIT 36 RESERVING table1 FOR SHARED READ;**

```
$ RMU/UNLOAD-
  /TRANSACTION_TYPE=(SHARED, ISOLATION=REPEAT, WAIT=36) -
  SAMPLE.RDB-
  TABLE1-
  TABLE.DAT
```

Example 11

1.62 RMU Unload Command

The following example specifies the options that were the default transaction style in prior releases.

```
$ RMU/UNLOAD-  
  /TRANSACTION_TYPE=(READ_ONLY, ISOLATION_LEVEL=SERIALIZABLE) -  
  SAMPLE.RDB-  
  TABLE1-  
  TABLE1.DAT
```

Example 12

If the database currently has snapshots deferred, it may be more efficient to start a read-write transaction with isolation level read committed. This allows the transaction to start immediately (a read-only transaction may stall), and the selected isolation level keeps row locking to a minimum.

```
$ RMU/UNLOAD-  
  /TRANSACTION_TYPE=(SHARED_READ, ISOLATION=READ_COMMITTED) -  
  SAMPLE.RDB-  
  TABLE1-  
  TABLE1.DAT
```

Using a transaction type of automatic adapts to different database settings.

```
$ RMU/UNLOAD-  
  /TRANSACTION_TYPE=(AUTOMATIC) -  
  SAMPLE.RDB-  
  TABLE1-  
  TABLE1.DAT
```

Example 13

The following example shows the output from the flags `STRATEGY` and `ITEM_LIST` which indicates that the `Optimize` qualifier specified that sequential access be used, and also that `Total_Time` is used as the default optimizer preference.

```
$ DEFINE RDMS$SET_FLAGS "STRATEGY,ITEM_LIST"  
$ RMU/UNLOAD/OPTIMIZE=SEQUENTIAL_ACCESS PERSONNEL EMPLOYEES E.DAT  
.  
.  
.  
~H Request Information Item List: (len=11)  
0000 (00000) RDB$K_SET_REQ_OPT_PREF "0"  
0005 (00005) RDB$K_SET_REQ_OPT_SEQ "1"  
000A (00010) RDB$K_INFO_END  
Get      Retrieval sequentially of relation EMPLOYEES  
%RMU-I-DATRECUNL,   100 data records unloaded.
```

Example 14

1.62 RMU Unload Command

AUTOMATIC columns are evaluated during INSERT and UPDATE operations for a table; for instance, they may record the timestamp for the last operation. If the table is being reorganized, it may be necessary to unload the data and reload it after the storage map and indexes for the table are re-created, yet the old auditing data must remain the same.

Normally, the RMU Unload command does not unload columns marked as AUTOMATIC; you must use the Virtual_Fields qualifier with the keyword Automatic to request this action.

```
$ rmu/unload/virtual_fields=(automatic) payroll_db people people.unl
```

Following the restructure of the database, the data can be reloaded. If the target columns are also defined as AUTOMATIC, then the RMU Load process will not write to those columns. You must use the Virtual_Fields qualifier with the keyword Automatic to request this action.

```
$ rmu/load/virtual_fields=(automatic) payroll_db people people.unl
```

Example 15

This example shows the action of the Delete_Rows qualifier. First, SQL is used to display the count of the rows in the table. The file PEOPLE.COLUMNS is verified (written to SYS\$OUTPUT) by the RMU Unload command.

```
$ define sql$database db$:scratch
$ sql$ select count (*) from people;

          100
1 row selected
$ rmu/unload/fields="@people.columns" -
  sql$database -
  /record_definition=(file:people,format:delimited) -
  /delete_rows -
  people -
  people2.dat
EMPLOYEE_ID
LAST_NAME
FIRST_NAME
MIDDLE_INITIAL
SEX
BIRTHDAY
%RMU-I-DATRECERA, 100 data records erased.
%RMU-I-DATRECUNL, 100 data records unloaded.
```

A subsequent query shows that the rows have been deleted.

```
$ sql$ select count (*) from people;

          0
1 row selected
```

1.62 RMU Unload Command

Example 16

The following example shows the output from the RMU Unload command options for XML support. The two files shown in the example are created by this RMU Unload command:

```
$ rmu/unload -
  /record_def=(format=xml,file=work_status) -
  mf_personnel -
  work_status -
  work_status.xml
```

Output WORK_STATUS.DTD file

```
<?xml version="1.0"?>
<!-- RMU Unload for Oracle Rdb V7.1-00 -->
<!-- Generated: 16-MAR-2001 22:26:47.30 -->

<!ELEMENT WORK_STATUS (RMU_ROW*)>
<!ELEMENT RMU_ROW (
  STATUS_CODE,
  STATUS_NAME,
  STATUS_TYPE
)>
<!ELEMENT STATUS_CODE (#PCDATA)>
<!ELEMENT STATUS_NAME (#PCDATA)>
<!ELEMENT STATUS_TYPE (#PCDATA)>
<!ELEMENT NULL (EMPTY)>
```

Output WORK_STATUS.XML file

```
<?xml version="1.0"?>
<!-- RMU Unload for Oracle Rdb V7.1-00 -->
<!-- Generated: 16-MAR-2001 22:26:47.85 -->

<!DOCTYPE WORK_STATUS SYSTEM "work_status.dtd">

<WORK_STATUS>
  <RMU_ROW>
    <STATUS_CODE>0</STATUS_CODE>
    <STATUS_NAME>INACTIVE</STATUS_NAME>
    <STATUS_TYPE>RECORD EXPIRED</STATUS_TYPE>
  </RMU_ROW>
  <RMU_ROW>
    <STATUS_CODE>1</STATUS_CODE>
    <STATUS_NAME>ACTIVE </STATUS_NAME>
    <STATUS_TYPE>FULL TIME </STATUS_TYPE>
  </RMU_ROW>
  <RMU_ROW>
    <STATUS_CODE>2</STATUS_CODE>
    <STATUS_NAME>ACTIVE </STATUS_NAME>
    <STATUS_TYPE>PART TIME </STATUS_TYPE>
  </RMU_ROW>
</WORK_STATUS>
```

1.62 RMU Unload Command

```
<!-- 3 rows unloaded -->
```

Example 17

The following example shows that if the `Flush=On_Commit` qualifier is specified, the value for the `Commit_Every` qualifier must be equal to or a multiple of the `Row_Count` value so the commits of unload transactions occur after the internal RMS buffers are flushed to the unload file. This prevents loss of data if an error occurs.

```
$RMU/UNLOAD/ROW_COUNT=5/COMMIT_EVERY=2/FLUSH=ON_COMMIT MF_PERSONNEL -
_ $ EMPLOYEES EMPLOYEES
%RMU-F-DELROWCOM, For DELETE_ROWS or FLUSH=ON_COMMIT the COMMIT_EVERY value must
  equal or be a multiple of the ROW_COUNT value.
The COMMIT_EVERY value of 2 is not equal to or a multiple of the ROW_COUNT value
  of 5.
%RMU-F-FTL_UNL, Fatal error for UNLOAD operation at 27-Oct-2005 08:55:14.06
```

Example 18

The following examples show that the unload file and record definition files are not deleted on error if the `Noerror_Delete` qualifier is specified and that these files are deleted on error if the `Error_Delete` qualifier is specified. If the unload file is empty when the error occurs, it will be deleted.

```
$RMU/UNLOAD/NOERROR_DELETE/ROW_COUNT=50/COMMIT_EVERY=50 MF_PERSONNEL -
_ $ EMPLOYEES EMPLOYEES.UNL
%RMU-E-OUTFILNOTDEL, Fatal error, the output file is not deleted but may not
  be useable,
  50 records have been unloaded.
-COSI-F-WRITERR, write error
-RMS-F-FUL, device full (insufficient space for allocation)

$RMU/UNLOAD/ERROR_DELETE/ROW_COUNT=50/COMMIT_EVERY=50 MF_PERSONNEL -
_ $ EMPLOYEES EMPLOYEES.UNL
%RMU-E-OUTFILDEL, Fatal error, output file deleted
-COSI-F-WRITERR, write error
-RMS-F-FUL, device full (insufficient space for allocation)
```

1.63 RMU Unload After_Journal Command

1.63 RMU Unload After_Journal Command

Allows you to extract added, modified, committed, and deleted record contents from committed transactions from specified tables in one or more after-image journal files.

Format

RMU/Unload/After_Journal root-file-spec aij-file-name

Command Qualifiers

/Before=date-time
/Continuous
/Extend_Size=integer
/Format=options
/Ignore=Old_Version[=table-list]
/Include=Action=(include-type)

/IO_Buffers=integer
/[No]Log
/Options=options-list
/Order_AIJ_files
/Output=file-spec
/Parameter=character-strings
/Restart=(restart-point)
/Restore_Metadata=file-spec

/Save_Metadata=file-spec
/Select=selection-type
/Since=date-time
/Sort_Workfiles=integer
/Statistics_Interval=integer
/[No]Symbols
/Table=(Name=table-name,
[table-options ...])
/[No]Trace

Defaults

None
/NoContinuous
/Extend_Size=1000
See description
/Ignore=Old_Version=all
Include=Action=
(NoCommit,Modify,Delete)
/IO_Buffers=2
Current DCL verify value
See description
/NoOrder_ajj_files
/Output=SYS\$OUTPUT
None
None
None

None
/Select=Commit_Transaction
None
/Sort_Workfiles=2
See description
/Symbols
See description
None
/Notrace

Description

The RMU Unload After_Journal command translates the binary data record contents of an after-image journal (.aij) file into an output file. Data records for the specified tables for committed transactions are extracted to an output stream (file, device, or application callback) in the order that the transactions were committed.

1.63 RMU Unload After_Journal Command

Before you use the RMU Unload After_Journal command, you must enable the database for LogMiner extraction. Use the RMU Set Logminer command to enable the LogMiner for Rdb feature for the database. Before you use the RMU Unload After_Journal command with the Continuous qualifier, you must enable the database for Continuous LogMiner extraction. See Section 1.56 for more information.

Data records extracted from the .aij file are those records that transactions added, modified, or deleted in base database tables. Index nodes, database metadata, segmented strings (BLOB), views, COMPUTED BY columns, system relations, and temporary tables cannot be unloaded from after-image journal files.

For each transaction, only the final content of a record is extracted. Multiple changes to a single record within a transaction are condensed so that only the last revision of the record appears in the output stream. You cannot determine which columns were changed in a data record directly from the after-image journal file. In order to determine which columns were changed, you must compare the record in the after-image journal file with a previous record.

The database used to create the after-image journal files being extracted must be available during the RMU Unload After_Journal command execution. The database is used to obtain metadata information (such as table names, column counts, record version, and record compression) needed to extract data records from the .aij file. The database is read solely to load the metadata and is then detached. Database metadata information can also be saved and used in a later session. See the Save_MetaData and Restore_MetaData qualifiers for more information.

If you use the Continuous qualifier, the database must be opened on the node where the Continuous LogMiner process is running. The database is always used and must be available for both metadata information and for access to the online after-image journal files. The Save_MetaData and Restore_MetaData qualifiers are not permitted with the Continuous qualifier.

When one or more .aij files and the Continuous qualifier are both specified on the RMU Unload After_Journal command line, it is important that no .aij backup operations occur until the Continuous LogMiner process has transitioned to online mode (where the active online .aij files are being extracted). If you are using automatic .aij backups and wish to use the Continuous LogMiner feature, Oracle recommends that you consider disabling the automatic backup feature (ABS) and use manual .aij backups so that you can explicitly control when .aij backup operations occur.

The after-image journal file or files are processed sequentially. All specified tables are extracted in one pass through the after-image journal file.

1.63 RMU Unload After_Journal Command

As each transaction commit record is processed, all modified and deleted records for the specified tables are sorted to remove duplicates. The modified and deleted records are then written to the output streams. Transactions that were rolled back are ignored. Data records for tables that are not being extracted are ignored. The actual order of output records within a transaction is not predictable.

In the extracted output, records that were modified or added are returned as being modified. It is not possible to distinguish between inserted and updated records in the output stream. Deleted (erased) records are returned as being deleted. A transaction that modifies and deletes a record generates only a deleted record. A transaction that adds a new record to the database and then deletes it within the same transaction generates only a deleted record.

The LogMiner process signals that a row has been deleted by placing a D in the RDB\$LM_ACTION field. The contents of the row at the instant before the delete operation are recorded in the user fields of the output record. If a row was modified several times within a transaction before being deleted, the output record contains only the delete indicator and the results of the last modify operation. If a row is inserted and deleted in the same transaction, only the delete record appears in the output.

Records from multiple tables can be output to the same or to different destination streams. Possible output destination streams include the following:

- File
- OpenVMS Mailbox
- OpenVMS Pipe
- Direct callback to an application through a run-time activated shareable image

Refer to Appendix B for more information about using the LogMiner for Rdb feature.

Command Parameters

root-file-spec

The root file specification of the database for the after-image journal file from which tables will be unloaded. The default file extension is .rdb.

The database must be the same actual database that was used to create the after-image journal files. The database is required so that the table metadata (information about data) is available to the RMU Unload After_Journal command. In particular, the names and relation identification of valid tables

1.63 RMU Unload After_Journal Command

within the database are required along with the number of columns in the table and the compression information for the table in various storage areas.

The RMU Unload After_Journal process attaches to the database briefly at the beginning of the extraction operation in order to read the metadata. Once the metadata has been read, the process disconnects from the database for the remainder of the operation unless the Continuous qualifier is specified. The Continuous qualifier indicates that the extraction operation is to run non-stop, and the process remains attached to the database.

aij-file-name

One or more input after-image journal backup files to be used as the source of the extraction operation. Multiple journal files can be extracted by specifying a comma-separated list of file specifications. Oracle RMU supports OpenVMS wildcard specifications (using the * and % characters) to extract a group of files. A file specification beginning with the at (@) character refers to an options file containing a list of after-image journal files (rather than the file specification of an after-image journal itself). If you use the at character syntax, you must enclose the at character and the file name in double quotation marks (for example, specify aij-file-name as "@files.opt"). The default file extension is .aij.

Command Qualifiers

Before=date-time

Specifies the ending time and date for transactions to be extracted. Based on the Select qualifier, transactions that committed or started prior to the specified Before date are selected. Information changed due to transactions that committed or started after the Before date is not included in the output.

Continuous

NoContinuous

Causes the LogMiner process to attach to the database and begin extracting records in "near-real" time. When the Continuous qualifier is specified, the RMU Unload After_Journal command extracts records from the online after-image journal files of the database until it is stopped via an external source (for example, Ctrl/y, STOP/ID, \$FORCEX, or database shutdown).

A database must be explicitly enabled for the Continuous LogMiner feature. To enable the Continuous LogMiner feature, use the RMU Set Logminer command with the Enable and Continuous qualifiers; to disable use of the Continuous LogMiner feature, use the RMU Set Logminer command with the Enable and Nocontinuous qualifiers.

1.63 RMU Unload After_Journal Command

The output from the Continuous LogMiner process is a continuous stream of information. The intended use of the Continuous LogMiner feature is to write the changes into an OpenVMS mailbox or pipe, or to call a user-supplied callback routine. Writing output to a disk file is completely functional with the Continuous LogMiner feature, however, no built-in functionality exists to prevent the files from growing indefinitely.

It is important that the callback routine or processing of the mailbox be very responsive. If the user-supplied callback routine blocks, or if the mailbox is not being read fast enough and fills, the RMU Unload After_Journal command will stall. The Continuous LogMiner process prevents backing up the after-image journal that it is currently extracting along with all subsequent journals. If the Continuous LogMiner process is blocked from executing for long enough, it is possible that all available journals will fill and will not be backed up.

When a database is enabled for the Continuous LogMiner feature, an AIJ "High Water" lock (AIJHWM) is utilized to help coordinate and maintain the current .ajj end-of-file location. The lock value block for the AIJHWM lock contains the location of the highest written .ajj block. The RMU Unload After_Journal command with the Continuous qualifier polls the AIJHWM lock to determine if data has been written to the .ajj file and to find the highest written block. If a database is not enabled for the Continuous LogMiner feature, there is no change in locking behavior; the AIJHWM lock is not maintained and thus the Continuous qualifier of the RMU Unload After_Journal command is not allowed.

In order to maintain the .ajj end-of-file location lock, processes that write to the after-image journal file must use the lock to serialize writing to the journal. When the Continuous LogMiner feature is not enabled, processes instead coordinate allocating space in the after-image journal file and can write to the file without holding a lock. The Continuous LogMiner process requires that the AIJHWM lock be held during the .ajj I/O operation. In some cases, this can reduce overall throughput to the .ajj file as it serves to reduce multiple over-lapped I/O write operations by multiple processes.

The Save_Metadata and Restore_Metadata qualifiers are incompatible with the Continuous qualifier.

Extend_Size=integer

Specifies the file allocation and extension quantity for output data files. The default extension size is 1000 blocks. Using a larger value can help reduce output file fragmentation and can improve performance when large amounts of data are extracted.

1.63 RMU Unload After_Journal Command

Format=options

If the Format qualifier is not specified, Oracle RMU outputs data to a fixed-length binary flat file.

The format options are:

- Format=Binary

If you specify the Format=Binary option, Oracle RMU does not perform any data conversion; data is output in a flat file format with all data in the original binary state.

Table 1–19 describes the output fields and data types of an output record in Binary format.

Table 1–19 Output Fields

Field Name	Data Type	Byte Length	Description
ACTION	CHAR (1)	1	Indicates record state. "M" indicates an insert or modify action. "D" indicates a delete action. "E" indicates stream end-of-file (EOF) when a callback routine is being used. "P" indicates a value from the command line Parameter qualifier when a callback routine is being used (see Parameter qualifier). "C" indicates transaction commit information when the Include=Action=Commit qualifier is specified.
RELATION_NAME	CHAR (31)	31	Table name. Space padded to 31 characters.
RECORD_TYPE	INTEGER (Longword)	4	The Oracle Rdb internal relation identifier.
DATA_LEN	SMALLINT (Word)	2	Length, in bytes, of the data record content.
NBV_LEN	SMALLINT (Word)	2	Length, in bits, of the null bit vector content.

(continued on next page)

1.63 RMU Unload After_Journal Command

Table 1–19 (Cont.) Output Fields

Field Name	Data Type	Byte Length	Description
DBK	BIGINT (Quadword)	8	Records logical database key. The database key is a 3-field structure containing a 16-bit line number, a 32-bit page number and a 16-bit area number.
START_TAD	DATE VMS (Quadword)	8	Date/time of the start of the transaction.
COMMIT_TAD	DATE VMS (Quadword)	8	Date/time of the commitment of the transaction.
TSN	BIGINT (Quadword)	8	Transaction sequence number of the transaction that performed the record operation.
RECORD_VERSION	SMALLINT (Word)	2	Record version.
Record Data	Varies		Actual data record field contents.
Record NBV	BIT VECTOR (array of bits)		Null bit vector. There is one bit for each field in the data record. If a bit value is 1, the corresponding field is NULL; if a bit value is 0, the corresponding field is not NULL and contains an actual data value. The null bit vector begins on a byte boundary. Any extra bits in the final byte of the vector after the final null bit are unused.

- **Format=Dump**

If you specify the Format=Dump option, Oracle RMU produces an output format suitable for viewing. Each line of Dump format output contains the column name (including LogMiner prefix columns) and up to 200 bytes of the column data. Unprintable characters are replaced with periods (.), and numbers and dates are converted to text. NULL columns are indicated with the string "NULL". This format is intended to assist in debugging; the actual output contents and formatting will change in the future.

1.63 RMU Unload After_Journal Command

- **Format=Text**

If you specify the **Format=Text** option, Oracle RMU converts all data to printable text in fixed-length columns before unloading it. **VARCHAR(n)** strings are padded with blanks when the specified string has fewer characters than *n* so that the resulting string is *n* characters long.
- **Format=(Delimited_Text [,delimiter-options])**

If you specify the **Format=Delimited_Text** option, Oracle RMU applies delimiters to all data before unloading it.

DATE VMS dates are output in the collatable time format, which is **yyyymmddhhmmsscc**. For example, March 20, 1993 is output as: **1993032000000000**.

Delimiter options are:

 - **Prefix=string**

Specifies a prefix string that begins any column value in the ASCII output file. If you omit this option, the column prefix is a quotation mark (").
 - **Separator=string**

Specifies a string that separates column values of a row. If you omit this option, the column separator is a single comma (,).
 - **Suffix=string**

Specifies a suffix string that ends any column value in the ASCII output file. If you omit this option, the column suffix is a quotation mark (").
 - **Terminator=string**

Specifies the row terminator that completes all the column values corresponding to a row. If you omit this option, the row terminator is the end of the line.
 - **Null=string**

Specifies a string that, when found in the database column, is unloaded as "NULL" in the output file.

The Null option can be specified on the command line as any one of the following:

 - * A quoted string
 - * An empty set of double quotes ("")
 - * No string

1.63 RMU Unload After_Journal Command

The string that represents the null character must be quoted on the Oracle RMU command line. You cannot specify a blank space or spaces as the null character. You cannot use the same character for the Null value and other Delimited_Text options.

Note

The values for each of the strings specified in the delimiter options must be enclosed within quotation marks. Oracle RMU strips these quotation marks while interpreting the values. If you want to specify a quotation mark (") as a delimiter, specify a string of four quotation marks. Oracle RMU interprets four quotation marks as your request to use one quotation mark as a delimiter. For example, `Suffix = """"`.

Oracle RMU reads these quotation marks as follows:

- The first quotation mark is stripped from the string.
- The second and third quotation mark are interpreted as your request for one quotation mark (") as a delimiter.
- The fourth quotation mark is stripped.

This results in one quotation mark being used as a delimiter.

Furthermore, if you want to specify a quotation mark as part of the delimited string, you must use two quotation marks for each quotation mark that you want to appear in the string. For example, `Suffix = ""*""*""` causes Oracle RMU to use a delimiter of `*""*"`.

Ignore=Old_Version[=table-list]

Specifies optional conditions or items to ignore.

The RMU Unload After_Journal command treats non-current record versions in the AIJ file as a fatal error condition. That is, attempting to extract a record that has a record version not the same as the table's current maximum version results in a fatal error.

There are, however, some very rare cases where a verb rollback of a modification of a record may result in an old version of a record being written to the after-image journal even though the transaction did not actually complete a successful modification to the record. The RMU Unload After_Journal command detects the old record version and aborts with a fatal error in this unlikely case.

1.63 RMU Unload After_Journal Command

When the Ignore=Old_Version qualifier is present, the RMU Unload After_Journal command displays a warning message for each record that has a non-current record version and the record is not written to the output stream. The Old_Version qualifier accepts an optional list of table names to indicate that only the specified tables are permitted to have non-current record version errors ignored.

Include=Action=include-type

Specifies if deleted or modified records or transaction commit information is to be extracted from the after-image journal. The following keywords can be specified:

- Commit
NoCommit

If you specify Commit, a transaction commit record is written to each output stream as the final record for each transaction. The commit information record is written to output streams after all other records for the transaction have been written. The default is NoCommit.

Because output streams are created with a default file name of the table being extracted, it is important to specify a unique file name on each occurrence of the output stream. The definition of "unique" is such that when you write to a non-file-oriented output device (such as a pipe or mailbox), you must be certain to specify a specific file name on each output destination. This means that rather than specifying Output=MBA1234: for each output stream, you should use Output=MBA1234:MBX, or any file name that is the same on all occurrences of MBA1234:.

Failure to use a specific file name can result in additional, and unexpected, commit records being returned. However, this is generally a restriction only when using a stream-oriented output device (as opposed to a disk file).

The binary record format is based on the standard LogMiner output format. However, some fields are not used in the commit action record. The binary format and contents of this record are shown in Table 1–20. This record type is written for all output data formats.

Table 1–20 Commit Record Contents

Field	Length (in bytes)	Contents
ACTION	1	"C"

(continued on next page)

1.63 RMU Unload After_Journal Command

Table 1–20 (Cont.) Commit Record Contents

Field	Length (in bytes)	Contents
RELATION	31	Zero
RECORD_TYPE	4	Zero
DATA_LEN	2	Length of RM_TID_LEN, AERCP_LEN, RM_TID, AERCP
NBV_LEN	2	Zero
TID	4	Transaction (Attach) ID
PID	4	Process ID
START_TAD	8	Transaction Start Time/Date
COMMIT_TAD	8	Transaction Commit Time/Date
TSN	8	Transaction ID
RM_TID_LEN	4	Length of the Global TID
AERCP_LEN	4	Length of the AERCP information
RM_TID	RM_TID_LEN	Global TID
AERCP	AERCP_LEN	Restart Control Information

When the original transaction took part in a distributed, two-phase transaction, the RM_TID component is the Global transaction manager (XA or DDTM) unique transaction ID. Otherwise, this field contains binary zeroes.

The AIJ Extract Recovery Control Point (AERCP) information is used to uniquely identify this transaction within the scope of the database and after-image journal files. It contains the .ajj sequence number, VBN and TSN of the last "Micro Quiet Point", and is used by the Continuous LogMiner process to restart a particular point in the journal sequence.

- Delete
NoDelete

If you specify Delete, pre-deletion record contents are extracted from the ajj file. If you specify NoDelete, no pre-deletion record contents are extracted. The default is Delete.

- Modify
NoModify

1.63 RMU Unload After_Journal Command

If you specify Modify, modified or added record contents are extracted from the .ajj file. If you specify NoModify, then no modified or added record contents are extracted. The default is Modify.

IO_Buffers=integer

Specifies the number of I/O buffers used for output data files. The default number of buffers is two, which is generally adequate. With sufficiently fast I/O subsystem hardware, additional buffers may improve performance. However, using a larger number of buffers will also consume additional virtual memory and process working set.

Log

Nolog

Specifies that the extraction of the .ajj file is to be reported to SYS\$OUTPUT or the destination specified with the Output qualifier. When activity is logged, the output from the Log qualifier provides the number of transactions committed or rolled back. The default is the setting of the DCL VERIFY flag, which is controlled by the DCL SET VERIFY command.

Options=options-list

The following options can be specified:

- File=file-spec

An options file contains a list of tables and output destinations. The options file can be used instead of, or along with, the Table qualifier to specify the tables to be extracted. Each line of the options file must specify a table name prefixed with "Table=". After the table name, the output destination is specified as either "Output=", or "Callback_Module=" and "Callback_Routine=", for example:

```
TABLE=tblname,OUTPUT=outfile  
TABLE=tblname,CALLBACK_MODULE=image,CALLBACK_ROUTINE=routine
```

You can use the Record_Definition=file-spec option from the Table qualifier to create a record definition file for the output data. The default file type is .rrd; the default file name is the name of the table.

You can use the Table_Definition=file-spec option from the Table qualifier to create a file that contains an SQL statement that creates a table to hold transaction data. The default file type is .sql; the default file name is the name of the table.

1.63 RMU Unload After_Journal Command

Each option in the Options=File qualifier must be fully specified (no abbreviations are allowed) and followed with an equal sign (=) and a value string. The value string must be followed by a comma or the end of a line. Continuation lines can be specified by using a trailing dash. Comments are indicated by using the exclamation point (!) character.

You can use the asterisk (*) and the percent sign (%) wildcard characters in the table name specification to select all tables that satisfy the components you specify. The asterisk matches zero or more characters; the percent sign matches a single character.

For table name specifications that contain wild card characters, if the first character of the string is a pound sign (#), the wildcard specification is changed to a "not matching" comparison. This allows exclusion of tables based on a wildcard specification. The pound sign designation is only evaluated when the table name specification contains an asterisk or percent sign.

For example, a table name specification of "#FOO%" indicates that all table names that are four characters long and do *not* start with the string "FOO" are to be selected.

- **Shared_Read**
Specifies that the input after-image journal backup files are to be opened with an RMS shared locking specification.
- **Dump**
Specifies that the contents of an input metadata file are to be formatted and displayed. Typically, this information is used as a debugging tool.

Order_AIJ_Files

NoOrder_AIJ_Files

By default, after-image journal files are processed in the order that they are presented to the RMU Unload After_Journal command. The Order_AIJ_Files qualifier specifies that the input after-image journal files are to be processed in increasing order by sequence number. This can be of benefit when you use wildcard (* or %) processing of a number of input files. The .aij files are each opened, the first block is read (to determine the sequence number), and the files are closed prior to the sorting operation.

Output=file-spec

Redirects the log and trace output (selected with the Log and Trace qualifiers) to the named file. If this qualifier is not specified, the output generated by the Log and Trace qualifiers, which can be voluminous, is displayed to SYS\$OUTPUT.

1.63 RMU Unload After_Journal Command

Parameter=character-strings

Specifies one or more character strings that are concatenated together and passed to the callback routine upon startup.

For each table that is associated with a user-supplied callback routine, the callback routine is called with two parameters: the length of the Parameter record and a pointer to the Parameter record. The binary format and contents of this record are shown in Table 1–21.

Table 1–21 Parameter Record Contents

Field	Length (in bytes)	Contents
ACTION	1	"P"
RELATION	31	Relation name
RECORD_TYPE	4	Zero
DATA_LEN	2	Length of parameter string
NBV_LEN	2	Zero
LDBK	8	Zero
START_TAD	8	Zero
COMMIT_TAD	8	Zero
TSN	8	Zero
DATA	?	Variable length parameter string content

Restart=restart-point

Specifies an AIJ Extract Restart Control Point (AERCP) that indicates the location to begin the extraction. The AERCP indicates the transaction sequence number (TSN) of the last extracted transaction along with a location in the .aj file where a known "Micro-quiet point" exists.

When the Restart qualifier is not specified and no input after-image journal files are specified on the command line, the Continuous LogMiner process starts extracting at the beginning of the earliest modified online after-image journal file.

When formatted for text display, the AERCP structure consists of the six fields (the MBZ field is excluded) displayed as unsigned integers separated by dashes; for example, "1-28-12-7-3202-3202".

1.63 RMU Unload After_Journal Command

Restore_Metadata=file-spec

Specifies that the RMU Unload After_Journal command is to read database metadata information from the specified file. The Database parameter is required but the database itself is not accessed when the Restore_Metadata qualifier is specified. The default file type is .metadata. The Continuous qualifier is not allowed when the Restore_Metadata qualifier is present.

Because the database is not available when the Restore_Metadata qualifier is specified, certain database-specific actions cannot be taken. For example, checks for after-image journaling are disabled. Because the static copy of the metadata information is not updated as database structure and table changes are made, it is important to make sure that the metadata file is saved after database DML operations.

When the Restore_Metadata qualifier is specified, additional checks are made to ensure that the after-image journal files were created using the same database that was used to create the metadata file. These checks provide additional security and help prevent accidental mismatching of files.

Save_Metadata=file-spec

Specifies that the RMU Unload After_Journal command is to write metadata information to the named file. The Continuous, Restore_Metadata, Table, and Options=file qualifiers and the `aij-file-name` parameter are not allowed when the Save_Metadata qualifier is present. The default file type is .metadata.

Select=selection-type

Specifies if the date and time of the Before and Since qualifiers refer to transaction start time or transaction commit time.

The following options can be specified as the selection-type of the Select qualifier:

- **Commit_Transaction**
Specifies that the Before and Since qualifiers select transactions based on the time of the transaction commit.

1.63 RMU Unload After_Journal Command

- **Start_Transaction**
Specifies that the Before and Since qualifiers select transactions based on the time of the transaction start.

The default for date selection is Commit_Transaction.

Since=date-time

Specifies the starting time for transactions to be extracted. Depending on the value specified in the Select qualifier, transactions that committed or started on or after the specified Since date are selected. Information from transactions that committed or started prior to the specified Since date is not included in the output.

Sort_Workfiles=integer

Specifies the number of sort work files. The default number of sort work files is two. When large transactions are being extracted, using additional sort work files may improve performance by distributing I/O loads over multiple disk devices. Use the SORTWORKn (where n is a number from 0 to 9) logical names to specify the location of the sort work files.

Statistics_Interval=integer

Specifies that statistics are to be displayed at regular intervals so that you can evaluate the progress of the unload operation.

The displayed statistics include:

- Elapsed time
- CPU time
- Buffered I/O
- Direct I/O
- Page faults
- Number of records unloaded for a table
- Total number of records extracted for all tables

If the Statistics_Interval qualifier is specified, the default interval is 60 seconds. The minimum value is one second. If the unload operation completes successfully before the first time interval has passed, you will receive an informational message on the number of files unloaded. If the unload operation is unsuccessful before the first time interval has passed, you will receive error messages and statistics on the number of records unloaded.

At any time during the unload operation, you can press Ctrl/T to display the current statistics.

1.63 RMU Unload After_Journal Command

Symbols

Nosymbols

Specifies whether DCL symbols are to be created, indicating information about records extracted for each table.

If a large enough number of tables is being unloaded, too many associated symbols are created, and the CLI symbol table space can become exhausted. The error message "LIB-F-INSCLIMEM, insufficient CLI memory" is returned in this case. Specify the Nosymbols qualifier to prevent creation of the symbols.

The default is Symbols, which causes the symbols to be created.

Table=(Name=table-name, table-options)

Specifies the name of a table to be unloaded and an output destination. The table-name must be a table within the database. Views, indexes, and system relations may not be unloaded from the after-image journal file.

The asterisk (*) and the percent sign (%) wildcard characters can be used in the table name specification to select all tables that satisfy the components you specify. The asterisk matches zero or more characters and the percent sign matches a single character.

For table name specifications that contain wild card characters, if the first character of the string is a pound sign (#), the wildcard specification is changed to a "not matching" comparison. This allows exclusion of tables based on a wildcard specification. The pound sign designation is only evaluated when the table name specification contains an asterisk or percent sign.

For example, a table name specification of "#FOO%" indicates that all table names that are four characters long and do *not* start with the string "FOO" are to be selected.

The following table-options can be specified with the Table qualifier:

- **Callback_Module=image-name, Callback_Routine=routine-name**
The LogMiner process uses the OpenVMS library routine LIB\$FIND_IMAGE_SYMBOL to activate the specified shareable image and locate the specified entry point routine name. This routine is called with each extracted record. A final call is made with the Action field set to "E" to indicate the end of the output stream. These options must be specified together.
- **Control**

1.63 RMU Unload After_Journal Command

Use the Control table option to produce output files that can be used by SQL*Loader to load the extracted data into an Oracle database. This option must be used in conjunction with fixed text format for the data file. The Control table option can be specified on either the command line or in an options file.

- **Output=file-spec**
If an Output file specification is present, unloaded records are written to the specified location.
- **Record_Definition=file-spec**
The Record_Definition=file-spec option can be used to create a record definition file for the output data. The default file type is .rrd; the default file name is the name of the table.
- **Table_Definition=file-spec**
You can use the Table_Definition=file-spec option to create a file that contains an SQL statement that creates a table to hold transaction data. The default file type is .sql; the default file name is the name of the table.

Unlike other qualifiers where only the final occurrence of the qualifier is used by an application, the Table qualifier can be specified multiple times for the RMU Unload After_Journal command. Each occurrence of the Table qualifier must specify a different table.

Trace

NoTrace

Specifies that the unloading of the .ajj file be traced. The default is Notrace. When the unload operation is traced, the output from the Trace qualifier identifies transactions in the .ajj file by TSNs and describes what Oracle RMU did with each transaction during the unload process. You can specify the Log qualifier with the Trace qualifier.

Usage Notes

- To use the RMU Unload After_Journal command for a database, you must have the RMU\$DUMP privilege in the root file access control list (ACL) for the database or the OpenVMS SYSPRV or BYPASS privilege.
- Oracle Rdb after-image journaling protects the integrity of your data by recording all changes made by committed transactions to a database in a sequential log or journal file. Oracle Corporation recommends that you enable after-image journaling to record your database transaction activity

1.63 RMU Unload After_Journal Command

between full backup operations as part of your database restore and recovery strategy. In addition to LogMiner for Rdb, the after-image journal file is used to enable several database performance enhancements such as the fast commit, row cache, and hot standby features.

- When the Continuous qualifier is not specified, you can only extract changed records from a backup copy of the after-image journal files. You create this file using the RMU Backup After_Journal command.
You cannot extract from an .aij file that has been optimized with the RMU Optimize After_Journal command.
- As part of the extraction process, Oracle RMU sorts extracted journal records to remove duplicate record updates. Because .aij file extraction uses the OpenVMS Sort/Merge Utility (SORT/MERGE) to sort journal records for large transactions, you can improve the efficiency of the sort operation by changing the number and location of the work files used by SORT/MERGE. The number of work files is controlled by the Sort_Workfiles qualifier of the RMU Unload After_Journal command. The allowed values are 1 through 10 inclusive, with a default value of 2. The location of these work files can be specified with device specifications, using the SORTWORKn logical name (where n is a number from 0 to 9). See the OpenVMS documentation set for more information on using SORT/MERGE. See the *Oracle Rdb7 Guide to Database Performance and Tuning* for more information on using these Oracle Rdb logical names.
- When extracting large transactions, the RMU Unload After_Journal command may create temporary work files. You can redirect the .aij rollforward temporary work files to a different disk and directory location than the current default directory by assigning a different directory to the RDM\$BIND_AIJ_WORK_FILE logical name in the LNM\$FILE_DEV name table. This can help to alleviate I/O bottlenecks that might occur on the default disk.
- You can specify a search list by defining logicals RDB\$BIND_AIJ_WORK_FILE1, RDB\$BIND_AIJ_WORK_FILE2, ... RDB\$BIND_AIJ_WORK_FILEn, with each logical pointing to a different device or directory. The numbers must start with 1 and increase sequentially without any gaps. When an AIJ file cannot be created due to a "device full" error, Oracle Rdb looks for the next device in the search list by translating the next sequential work file logical. If RDB\$BIND_AIJ_WORK_FILE is defined, it is used first.
- The RMU Unload After_Journal command can read either a backed up .aij file on disk or a backed up .aij file on tape that is in the Old_File format.

1.63 RMU Unload After_Journal Command

- You can select one or more tables to be extracted from an after-image journal file. All tables specified by the Table qualifier and all those specified in the Options file are combined to produce a single list of output streams. A particular table can be specified only once. Multiple tables can be written to the same output destination by specifying the exact same output stream specification (that is, by using an identical file specification).
- At the completion of the unload operation, RMU creates a number of DCL symbols that contain information about the extraction statistics. For each table extracted, RMU creates the following symbols:
 - RMU\$UNLOAD_DELETE_COUNT_tablename
 - RMU\$UNLOAD_MODIFY_COUNT_tablename
 - RMU\$UNLOAD_OUTPUT_tablename

The tablename component of the symbol is the name of the table. When multiple tables are extracted in one operation, multiple sets of symbols are created. The value for the symbols RMU\$UNLOAD_MODIFY_COUNT_tablename and RMU\$UNLOAD_DELETE_COUNT_tablename is a character string containing the number of records returned for modified and deleted rows. The RMU\$UNLOAD_OUTPUT_tablename symbol is a character string indicating the full file specification for the output destination, or the shareable image name and routine name when the output destination is an application callback routine.

- When you use the Callback_Module and Callback_Routine option, you must supply a shareable image with a universal symbol or entry point for the LogMiner process to be able to call your routine. See the OpenVMS documentation discussing the Linker utility for more information about creating shareable images.
- Your Callback_Routine is called once for each output record. The Callback_Routine is passed two parameters:
 - The length of the output record, by longword value
 - A pointer to the record buffer

The record buffer is a data structure of the same fields and lengths written to an output destination.

- Because the Oracle RMU image is installed as a known image, your shareable image must also be a known image. Use the OpenVMS Install Utility to make your shareable image known. You may wish to establish an exit handler to perform any required cleanup processing at the end of the extraction.

1.63 RMU Unload After_Journal Command

- Segmented string data (BLOB) cannot be extracted using the LogMiner process. Because the segmented string data is related to the base table row by means of a database key, there is no convenient way to determine what data to extract. Additionally, the data type of an extracted column is changed from LIST OF BYTE VARYING to BIGINT. This column contains the DBKEY of the original BLOB data. Therefore, the contents of this column should be considered unreliable. However, the field definition itself is extracted as a quadword integer representing the database key of the original segmented string data. In generated table definition or record definition files, a comment is added indicating that the segmented string data type is not supported by the LogMiner for Rdb feature.
- Records removed from tables using the SQL TRUNCATE TABLE statement are not extracted. The SQL TRUNCATE TABLE statement does not journal each individual data record being removed from the database.
- Records removed from tables using the SQL ALTER DATABASE command with the DROP STORAGE AREA clause and CASCADE keyword are not extracted. Any data deleted by this process is not journalled.
- Records removed by dropping tables using the SQL DROP TABLE statement are not extracted. The SQL DROP TABLE statement does not journal each individual data record being removed from the database.
- When the RDMS\$CREATE_LAREA_NOLOGGING logical is defined, DML operations are not available for extraction between the time the table is created and when the transaction is committed.
- Tables that use the vertical record partitioning (VRP) feature cannot be extracted using the LogMiner feature. LogMiner software currently does not detect these tables. A future release of Oracle Rdb will detect and reject access to vertically partitioned tables.
- In binary format output, VARCHAR fields are not padded with spaces in the output file. The VARCHAR data type is extracted as a 2-byte count field and a fixed-length data field. The 2-byte count field indicates the number of valid characters in the fixed-length data field. Any additional contents in the data field are unpredictable.
- You cannot extract changes to a table when the table definition is changed within an after-image journal file. Data definition language (DDL) changes to a table are not allowed within an .aij file being extracted. All records in an .aij file must be the current record version. If you are going to perform DDL operations on tables that you wish to extract using the LogMiner for Rdb, you should:
 1. Back up your after-image journal files.

1.63 RMU Unload After_Journal Command

2. Extract the .aij files using the RMU Unload After_Journal command.
 3. Make the DDL changes.
- Do not use the OpenVMS Alpha High Performance Sort/Merge utility (selected by defining the logical name SORTSHR to SYS\$SHARE:HYPERSORT) when using the LogMiner feature. HYPERSORT supports only a subset of the library sort routines that LogMiner requires. Make sure that the SORTSHR logical name is not defined to HYPERSORT.
 - The metadata information file used by the RMU Unload After_Journal command is in an internal binary format. The contents and format are not documented and are not directly accessible by other utilities. The content and format of the metadata information file is specific to a version of the RMU Unload After_Journal utility. As new versions and updates of Oracle Rdb are released, you will probably have to re-create the metadata information file. The same version of Oracle Rdb must be used to both write and read a metadata information file. The RMU Unload After_Journal command verifies the format and version of the metadata information file and issues an error message in the case of a version mismatch.
 - For debugging purposes, you can format and display the contents of a metadata information file by using the Options=Dump qualifier with the Restore_Metadata qualifier. This dump may be helpful to Oracle Support engineers during problem analysis. The contents and format of the metadata information file are subject to change.
 - If you use both the Output and Statistics_Interval qualifiers, the output stream used for the log, trace, and statistics information is flushed to disk (via the RMS \$FLUSH service) at each statistics interval. This makes sure that an output file of trace and log information is written to disk periodically.

Usage Notes for the Continuous LogMiner Feature

- You can specify input backup after-image journal files along with the Continuous qualifier from the command line. The specified after-image journal backup files are processed in an offline mode. Once they have been processed, the RMU Unload After_Journal command switches to “online” mode and the active online journals are processed.

1.63 RMU Unload After_Journal Command

- When no input after-image journal files are specified on the command line, the Continuous LogMiner starts extracting at the beginning of the earliest modified online after-image journal file. The Restart= qualifier can be used to control the first transaction to be extracted.
- The Continuous LogMiner requires fixed-size circular after-image journals.
- An after-image journal file cannot be backed up if there are any Continuous LogMiner checkpoints in the aij file. The Continuous LogMiner moves its checkpoint to the physical end-of-file for the online .aij file that it is extracting.
- In order to ensure that all records have been written by all database users, Continuous LogMiner processes do not switch to the next live journal file until it has been written to by another process. Live journals should not be backed up while the Continuous LogMiner process is processing a list of .aij backup files.
- If backed up after-image journal files are specified on the command line and the Continuous qualifier is specified, the journal sequence numbers must ascend directly from the backed up journal files to the online journal files.

In order to preserve the after-image journal file sequencing as processed by the RMU Unload After_Journal /Continuous command, it is important that no after-image journal backup operations are attempted between the start of the command and when the Continuous LogMiner process reaches the live online after-image journals.

- You can run multiple Continuous LogMiner processes at one time on a database. Each Continuous LogMiner process acts independently.
- The Continuous LogMiner reads the live after-image journal file just behind writers to the journal. This will likely increase the I/O load on the disk devices where the journals are located. The Continuous LogMiner attempts to minimize unneeded journal I/O by checking a “High Water Mark” lock to determine if the journal has been written to and where the highest written block location is located.
- Vertically partitioned tables cannot be extracted.

1.63 RMU Unload After_Journal Command

Examples

Example 1

The following example unloads the EMPLOYEES table from the .aij backup file MFP.AIJBCK.

```
RMU /UNLOAD /AFTER_JOURNAL MFP.RDB MFP.AIJBCK -  
    /TABLE = (NAME = EMPLOYEES, OUTPUT = EMPLOYEES.DAT)
```

1.63 RMU Unload After_Journal Command

Example 2

The following example simultaneously unloads the SALES, STOCK, SHIPPING, and ORDERS tables from the .aij backup files MFS.AIJBCK_1-JUL-1999 through MFS.AIJBCK_3-JUL-1999. Note that the input .aij backup files are processed sequentially in the order specified.

```
$ RMU /UNLOAD /AFTER_JOURNAL MFS.RDB -  
  MFS.AIJBCK_1-JUL-1999, -  
  MFS.AIJBCK_2-JUL-1999, -  
  MFS.AIJBCK_3-JUL-1999 -  
  /TABLE = (NAME = SALES, OUTPUT = SALES.DAT) -  
  /TABLE = (NAME = STOCK, OUTPUT = STOCK.DAT) -  
  /TABLE = (NAME = SHIPPING, OUTPUT = SHIPPING.DAT) -  
  /TABLE = (NAME = ORDER, OUTPUT = ORDER.DAT)
```

Example 3

Use the Before and Since qualifiers to unload data based on a time range. The following example extracts changes made to the PLANETS table by transactions that committed between 1-SEP-1999 at 14:30 and 3-SEP-1999 at 16:00.

```
$ RMU /UNLOAD /AFTER_JOURNAL MFS.RDB MFS.AIJBCK -  
  /TABLE = (NAME = PLANETS, OUTPUT = PLANETS.DAT) -  
  /BEFORE = "3-SEP-1999 16:00:00.00" -  
  /SINCE = "1-SEP-1999 14:30:00.00"
```

Example 4

The following example simultaneously unloads the SALES and STOCK tables from all .aij backup files that match the wildcard specification MFS.AIJBCK_1999-07-*. The input .aij backup files are processed sequentially in the order returned from the file system.

```
$ RMU /UNLOAD /AFTER_JOURNAL MFS.RDB -  
  MFS.AIJBCK_1999-07-* -  
  /TABLE = (NAME = SALES, OUTPUT = SALES.DAT) -  
  /TABLE = (NAME = STOCK, OUTPUT = STOCK.DAT)
```

Example 5

The following example unloads the TICKER table from the .aij backup files listed in the file called AIJ_BACKUP_FILES.DAT (note the double quotation marks surrounding the at (@) character and the file specification). The input .aij backup files are processed sequentially. The output records are written to the mailbox device called MBA127:. A separate program is already running on the system, and it reads and processes the data written to the mailbox.

1.63 RMU Unload After_Journal Command

```
$ RMU /UNLOAD /AFTER_JOURNAL MFS.RDB -  
  "@AIJ_BACKUP_FILES.DAT" -  
  /TABLE = (NAME = TICKER, OUTPUT = MBA127:)
```

Example 6

You can use the RMU Unload After_Journal command followed by RMU Load commands to move transaction data from one database into a change table in another database. You must create a record definition (.rrd) file for each table being loaded into the target database. The record definition files can be created by specifying the Record_Definition option on the Table qualifier.

```
$ RMU /UNLOAD /AFTER_JOURNAL OLTP.RDB MYAIJ.AIJBCK -  
  /TABLE = ( NAME = MYTBL, -  
            OUTPUT = MYTBL.DAT, -  
            RECORD_DEFINITION=MYLOGTBL) -  
  /TABLE = ( NAME = SALE, -  
            OUTPUT=SALE.DAT, -  
            RECORD_DEFINITION=SALELOGTBL)  
  
$ RMU /LOAD WAREHOUSE.RDB MYLOGTBL MYTBL.DAT -  
  /RECORD_DEFINITION = FILE = MYLOGTBL.RRD  
  
$ RMU /LOAD WAREHOUSE.RDB SALELOGTBL SALE.DAT -  
  /RECORD_DEFINITION = FILE = SALELOGTBL.RRD
```

Example 7

You can use an RMS file containing the record structure definition for the output file as an input file to the RMU Load command. The record description uses the CDO record and field definition format. This is the same format used by the RMU Load and RMU Unload commands when the Record_Definition qualifier is used. The default file extension is .rrd.

The record definitions for the fields that the LogMiner process writes to the output .rrd file are shown in the following table. These fields can be manually appended to a record definition file for the actual user data fields being unloaded. The file can be used to load a **transaction table** within a database. A transaction table is the output that the LogMiner process writes to a table consisting of sequential transactions performed in a database.

DEFINE FIELD RDB\$LM_ACTION	DATATYPE IS TEXT SIZE IS 1.
DEFINE FIELD RDB\$LM_RELATION_NAME	DATATYPE IS TEXT SIZE IS 31.
DEFINE FIELD RDB\$LM_RECORD_TYPE	DATATYPE IS SIGNED LONGWORD.
DEFINE FIELD RDB\$LM_DATA_LEN	DATATYPE IS SIGNED WORD.
DEFINE FIELD RDB\$LM_NBV_LEN	DATATYPE IS SIGNED WORD.
DEFINE FIELD RDB\$LM_DBK	DATATYPE IS SIGNED QUADWORD.
DEFINE FIELD RDB\$LM_START_TAD	DATATYPE IS DATE
DEFINE FIELD RDB\$LM_COMMIT_TAD	DATATYPE IS DATE
DEFINE FIELD RDB\$LM_TSN	DATATYPE IS SIGNED QUADWORD.
DEFINE FIELD RDB\$LM_RECORD_VERSION	DATATYPE IS SIGNED WORD.

1.63 RMU Unload After_Journal Command

Example 8

Instead of using the Table qualifier, you can use an Options file to specify the table or tables to be extracted, as shown in the following example.

```
$ TYPE TABLES.OPTIONS
TABLE=MYTBL, OUTPUT=MYTBL.DAT
TABLE=SALES, OUTPUT=SALES.DAT
$ RMU /UNLOAD /AFTER_JOURNAL OLTP.RDB MYAIJ.AIJBCK -
  /OPTIONS = FILE = TABLES.OPTIONS
```

Example 9

The following example unloads the EMPLOYEES table from the live database and writes all change records to the MBA145 device. A separate program is presumed to be reading the mailbox at all times and processing the records.

```
$ RMU /UNLOAD /AFTER_JOURNAL /CONTINUOUS MFP.RDB -
  /TABLE = (NAME = EMPLOYEES, OUTPUT = MBA145:)
```

Example 10

This example demonstrates unloading three tables (EMPLOYEES, SALES, and CUSTOMERS) to a single mailbox. Even though the mailbox is not a file-oriented device, the same file name is specified for each. This is required because the LogMiner process defaults the file name to the table name. If the same file name is not explicitly specified for each output stream destination, the LogMiner process assigns one mailbox channel for each table. When the file name is the same for all tables, the LogMiner process detects this and assigns only a single channel for all input tables.

```
$ DEFINE MBX$ LOADER_MBX:X
$ RMU /UNLOAD /AFTER_JOURNAL /CONTINUOUS MFP.RDB -
  /TABLE = (NAME = EMPLOYEES, OUTPUT = MBX$:) -
  /TABLE = (NAME = SALES, OUTPUT = MBX$:) -
  /TABLE = (NAME = CUSTOMERS, OUTPUT = MBX$:)
```

Example 11

In order to include transaction commit information, the /Include =Action =Commit qualifier is specified in this example. Additionally, the EMPLOYEES and SALES tables are extracted to two different mailbox devices (ready by separate processes). A commit record is written to each mailbox after all changed records for each transaction have been extracted.

```
$ RMU /UNLOAD /AFTER_JOURNAL /CONTINUOUS MFP.RDB -
  /INCLUDE = ACTION = COMMIT -
  /TABLE = (NAME = EMPLOYEES, OUTPUT = LOADER_EMP_MBX:X) -
  /TABLE = (NAME = SALES, OUTPUT = LOADER_SAL_MBX:X)
```

1.63 RMU Unload After_Journal Command

Example 12

In this example, multiple input backup after-image journal files are supplied. The `Order_AIJ_Files` qualifier specifies that the `.aij` files are to be processed in ascending order of `.aij` sequence number (regardless of file name). Prior to the extraction operation, each input file is opened and the `.aij` Open record is read. The `.aij` files are then opened and extracted, one at a time, by ascending `.aij` sequence number.

```
$ RMU /UNLOAD /AFTER_JOURNAL /LOG /ORDER_AIJ_FILES -
MFP.RDB *.AIJBCK -
/TABLE = (NAME = C1, OUTPUT=C1.DAT)
%RMU-I-UNLAIJFL, Unloading table C1 to DGA0:[DB]C1.DAT;1
%RMU-I-LOGOPNAIJ, opened journal file DGA0:[DB]ABLE.AIJBCK;1
%RMU-I-AIJRSTSEQ, journal sequence number is "5"
%RMU-I-LOGOPNAIJ, opened journal file DGA0:[DB]BAKER.AIJBCK;1
%RMU-I-AIJRSTSEQ, journal sequence number is "4"
%RMU-I-LOGOPNAIJ, opened journal file DGA0:[DB]CHARLIE.AIJBCK;1
%RMU-I-AIJRSTSEQ, journal sequence number is "6"
%RMU-I-LOGOPNAIJ, opened journal file DGA0:[DB]BAKER.AIJBCK;1
%RMU-I-AIJRSTSEQ, journal sequence number is "4"
%RMU-I-AIJMODSEQ, next AIJ file sequence number will be 5
%RMU-I-LOGOPNAIJ, opened journal file DGA0:[DB]ABLE.AIJBCK;1
%RMU-I-AIJRSTSEQ, journal sequence number is "5"
%RMU-I-AIJMODSEQ, next AIJ file sequence number will be 6
%RMU-I-LOGOPNAIJ, opened journal file DGA0:[DB]CHARLIE.AIJBCK;1
%RMU-I-AIJRSTSEQ, journal sequence number is "6"
%RMU-I-AIJMODSEQ, next AIJ file sequence number will be 7
%RMU-I-LOGSUMMARY, total 7 transactions committed
%RMU-I-LOGSUMMARY, total 0 transactions rolled back
-----
ELAPSED: 0 00:00:00.15 CPU: 0:00:00.08 BUFIO: 62 DIRIO: 19 FAULTS: 73
Table "C1" : 3 records written (3 modify, 0 delete)
Total : 3 records written (3 modify, 0 delete)
```

Example 13

The SQL record definitions for the fields that the LogMiner process writes to the output are shown in the following example. These fields can be manually appended to the table creation command for the actual user data fields being unloaded. Alternately, the `Table_Definition` qualifier can be used with the `Table` qualifier or within an Options file to automatically create the SQL definition file. This can be used to create a transaction table of changed data.

1.63 RMU Unload After_Journal Command

```
SQL> CREATE TABLE MYLOGTABLE (  
cont> RDB$LM_ACTION          CHAR,  
cont> RDB$LM_RELATION_NAME   CHAR (31),  
cont> RDB$LM_RECORD_TYPE     INTEGER,  
cont> RDB$LM_DATA_LEN        SMALLINT,  
cont> RDB$LM_NBV_LEN         SMALLINT,  
cont> RDB$LM_DBK             BIGINT,  
cont> RDB$LM_START_TAD       DATE VMS,  
cont> RDB$LM_COMMIT_TAD     DATE VMS,  
cont> RDB$LM_TSN             BIGINT,  
cont> RDB$LM_RECORD_VERSION  SMALLINT ...);
```

Example 14

The following example is the transaction table record definition (.rrd) file for the EMPLOYEES table from the PERSONNEL database:

```
DEFINE FIELD RDB$LM_ACTION          DATATYPE IS TEXT SIZE IS 1.  
DEFINE FIELD RDB$LM_RELATION_NAME   DATATYPE IS TEXT SIZE IS 31.  
DEFINE FIELD RDB$LM_RECORD_TYPE     DATATYPE IS SIGNED LONGWORD.  
DEFINE FIELD RDB$LM_DATA_LEN        DATATYPE IS SIGNED WORD.  
DEFINE FIELD RDB$LM_NBV_LEN         DATATYPE IS SIGNED WORD.  
DEFINE FIELD RDB$LM_DBK             DATATYPE IS SIGNED QUADWORD.  
DEFINE FIELD RDB$LM_START_TAD       DATATYPE IS DATE.  
DEFINE FIELD RDB$LM_COMMIT_TAD     DATATYPE IS DATE.  
DEFINE FIELD RDB$LM_TSN             DATATYPE IS SIGNED QUADWORD.  
DEFINE FIELD RDB$LM_RECORD_VERSION  DATATYPE IS SIGNED WORD.  
  
DEFINE FIELD EMPLOYEE_ID            DATATYPE IS TEXT SIZE IS 5.  
DEFINE FIELD LAST_NAME              DATATYPE IS TEXT SIZE IS 14.  
DEFINE FIELD FIRST_NAME             DATATYPE IS TEXT SIZE IS 10.  
DEFINE FIELD MIDDLE_INITIAL        DATATYPE IS TEXT SIZE IS 1.  
DEFINE FIELD ADDRESS_DATA_1        DATATYPE IS TEXT SIZE IS 25.  
DEFINE FIELD ADDRESS_DATA_2        DATATYPE IS TEXT SIZE IS 20.  
DEFINE FIELD CITY                  DATATYPE IS TEXT SIZE IS 20.  
DEFINE FIELD STATE                 DATATYPE IS TEXT SIZE IS 2.  
DEFINE FIELD POSTAL_CODE           DATATYPE IS TEXT SIZE IS 5.  
DEFINE FIELD SEX                   DATATYPE IS TEXT SIZE IS 1.  
DEFINE FIELD BIRTHDAY              DATATYPE IS DATE.  
DEFINE FIELD STATUS_CODE           DATATYPE IS TEXT SIZE IS 1.
```

1.63 RMU Unload After_Journal Command

```
DEFINE RECORD EMPLOYEES.  
  RDB$LM_ACTION .  
  RDB$LM_RELATION_NAME .  
  RDB$LM_RECORD_TYPE .  
  RDB$LM_DATA_LEN .  
  RDB$LM_NBV_LEN .  
  RDB$LM_DBK .  
  RDB$LM_START_TAD .  
  RDB$LM_COMMIT_TAD .  
  RDB$LM_TSN .  
  RDB$LM_RECORD_VERSION .  
  EMPLOYEE_ID .  
  LAST_NAME .  
  FIRST_NAME .  
  MIDDLE_INITIAL .  
  ADDRESS_DATA_1 .  
  ADDRESS_DATA_2 .  
  CITY .  
  STATE .  
  POSTAL_CODE .  
  SEX .  
  BIRTHDAY .  
  STATUS_CODE .  
END EMPLOYEES RECORD.
```

Example 15

The following C source code segment demonstrates the structure of a module that can be used as a callback module and routine to process employee transaction information from the LogMiner process. The routine, `Employees_Callback`, would be called by the LogMiner process for each extracted record. The final time the callback routine is called, the `RDB$LM_ACTION` field will be set to "E" to indicate the end of the output stream.

```
#include <stdio>  
typedef unsigned char date_type[8];  
typedef unsigned char dbkey_type[8];  
typedef unsigned char tsn_type[8];
```

1.63 RMU Unload After_Journal Command

```
typedef struct {
    unsigned char    rdb$lm_action;
    char             rdb$lm_relation_name[31];
    unsigned int     rdb$lm_record_type;
    unsigned short int rdb$lm_data_len;
    unsigned short int rdb$lm_nbv_len;
    dbkey_type       rdb$lm_dbk;
    date_type        rdb$lm_start_tad;
    date_type        rdb$lm_commit_tad;
    tsn_type         rdb$lm_tsn;
    unsigned short int rdb$lm_record_version;
    char             employee_id[5];
    char             last_name[14];
    char             first_name[10];
    char             middle_initial[1];
    char             address_data_1[25];
    char             address_data_2[20];
    char             city[20];
    char             state[2];
    char             postal_code[5];
    char             sex[1];
    date_type        birthday;
    char             status_code[1];
} transaction_data;

void employees_callback (unsigned int data_len, transaction_data
                        data_buf)
{
    .
    :
    .
    return;}

```

Use the C compiler (either VAX C or DEC C) to compile this module. When linking this module, the symbol `EMPLOYEES_CALLBACK` needs to be externalized in the shareable image. Refer to the OpenVMS manual discussing the Linker utility for more information about creating shareable images.

On OpenVMS Alpha systems, you can use a `LINK` command similar to the following:

```
$ LINK /SHAREABLE = EXAMPLE.EXE EXAMPLE.OBJ + SYS$INPUT: /OPTIONS
SYMBOL_VECTOR = (EMPLOYEES_CALLBACK = PROCEDURE)
<Ctrl/Z>
```

On OpenVMS VAX systems, you can use a `LINK` command similar to the following:

```
$ LINK /SHAREABLE = EXAMPLE.EXE EXAMPLE.OBJ + SYS$INPUT: /OPTIONS
UNIVERSAL = EMPLOYEES_CALLBACK
<Ctrl/Z>
```

1.63 RMU Unload After_Journal Command

Example 16

You can use triggers and a transaction table to construct a method to replicate table data from one database to another using RMU Unload After_Journal and RMU Load commands. This data replication method is based on transactional changes to the source table and requires no programming. Instead, existing features of Oracle Rdb can be combined to provide this functionality.

For this example, consider a simple customer information table called CUST with a unique customer ID value, customer name, address, and postal code. Changes to this table are to be moved from an OLTP database to a reporting database system on a periodic (perhaps nightly) basis.

First, in the reporting database, a customer table of the same structure as the OLTP customer table is created. In this example, this table is called RPT_CUST. It contains the same fields as the OLTP customer table called CUST.

```
SQL> CREATE TABLE RPT_CUST
cont> CUST_ID          INTEGER,
cont> CUST_NAME        CHAR (50),
cont> CUST_ADDRESS     CHAR (50),
cont> CUST_POSTAL_CODE INTEGER);
```

Next, a temporary table is created in the reporting database for the LogMiner-extracted transaction data from the CUST table. This temporary table definition specifies ON COMMIT DELETE ROWS so that data in the temporary table is deleted from memory at each transaction commit. A temporary table is used because there is no need to journal changes to the table.

```
SQL> CREATE GLOBAL TEMPORARY TABLE RDB_LM_RPT_CUST (
cont> RDB$LM_RECORD_TYPE  INTEGER,
cont> RDB$LM_DATA_LEN     SMALLINT,
cont> RDB$LM_NBV_LEN      SMALLINT,
cont> RDB$LM_DBK          BIGINT,
cont> RDB$LM_START_TAD    DATE VMS,
cont> RDB$LM_COMMIT_TAD   DATE VMS,
cont> RDB$LM_TSN          BIGINT,
cont> RDB$LM_RECORD_VERSION SMALLINT,
cont> CUST_ID             INTEGER,
cont> CUST_NAME           CHAR (50),
cont> CUST_ADDRESS        CHAR (50),
cont> CUST_POSTAL_CODE    INTEGER) ON COMMIT DELETE ROWS;
```

For data to be populated in the RPT_CUST table in the reporting database, a trigger is created for the RDB_LM_RPT_CUST transaction table. This trigger is used to insert, update, or delete rows in the RPT_CUST table based on the transaction information from the OLTP database for the CUST table.

1.63 RMU Unload After_Journal Command

The unique CUST_ID field is used to determine if customer records are to be modified or added.

```
SQL> CREATE TRIGGER RDB_LM_RPT_CUST_TRIG
cont> AFTER INSERT ON RDB_LM_RPT_CUST
cont>
cont> -- Modify an existing customer record
cont>
cont> WHEN (RDB$LM_ACTION = 'M' AND
cont>         EXISTS (SELECT RPT_CUST.CUST_ID FROM RPT_CUST
cont>                  WHERE RPT_CUST.CUST_ID =
cont>                        RDB_LM_RPT_CUST.CUST_ID))
cont> (UPDATE RPT_CUST SET
cont>      RPT_CUST.CUST_NAME = RDB_LM_RPT_CUST.CUST_NAME,
cont>      RPT_CUST.CUST_ADDRESS =
cont>      RDB_LM_RPT_CUST.CUST_ADDRESS,
cont>      RPT_CUST.CUST_POSTAL_CODE =
cont>      RDB_LM_RPT_CUST.CUST_POSTAL_CODE
cont>      WHERE RPT_CUST.CUST_ID = RDB_LM_RPT_CUST.CUST_ID)
cont> FOR EACH ROW
cont>
cont> -- Add a new customer record
cont>
cont> WHEN (RDB$LM_ACTION = 'M' AND NOT
cont>         EXISTS (SELECT RPT_CUST.CUST_ID FROM RPT_CUST
cont>                  WHERE RPT_CUST.CUST_ID =
cont>                        RDB_LM_RPT_CUST.CUST_ID))
cont> (INSERT INTO RPT_CUST VALUES
cont>      (RDB_LM_RPT_CUST.CUST_ID,
cont>      RDB_LM_RPT_CUST.CUST_NAME,
cont>      RDB_LM_RPT_CUST.CUST_ADDRESS,
cont>      RDB_LM_RPT_CUST.CUST_POSTAL_CODE))
cont> FOR EACH ROW
cont>
cont> -- Delete an existing customer record
cont>
cont> WHEN (RDB$LM_ACTION = 'D')
cont> (DELETE FROM RPT_CUST
cont>      WHERE RPT_CUST.CUST_ID = RDB_LM_RPT_CUST.CUST_ID)
cont> FOR EACH ROW;
```

Within the trigger, the action to take (for example, to add, update, or delete a customer record) is based on the RDB\$LM_ACTION field (defined as D or M) and the existence of the customer record in the reporting database. For modifications, if the customer record does not exist, it is added; if it does exist, it is updated. For a deletion on the OLTP database, the customer record is deleted from the reporting database.

1.63 RMU Unload After_Journal Command

The RMU Load command is used to read the output from the LogMiner process and load the data into the temporary table where each insert causes the trigger to execute. The Commit_Every qualifier is used to avoid filling memory with the customer records in the temporary table because as soon as the trigger executes, the record in the temporary table is no longer needed.

```
$ RMU /UNLOAD /AFTER_JOURNAL OLTP.RDB OLTP.AIJBCK -  
  /TABLE = (NAME = CUST, -  
           OUTPUT = CUST.DAT, -  
           RECORD_DEFINITION = RDB_LM_RPT_CUST.RRD)  
  
$ RMU /LOAD REPORT_DATABASE.RDB RDB_LM_RPT_CUST CUST.DAT -  
  /RECORD_DEFINITION = FILE = RDB_LM_RPT_CUST.RRD -  
  /COMMIT_EVERY = 1000
```

Example 17

The following example shows how to produce a control file that can be used by SQL*Loader to load the extracted data into an Oracle database.

```
$ RMU/UNLOAD/AFTER TEST_DB TEST_DB_AIJ1_BCK -  
  /FORMAT=TEXT -  
  /TABLE=(NAME=TEST_TBL, -  
         OUTPUT=LOGMINER_TEXT.TXT, -  
         CONTROL=LOGMINER_CONTROL.CTL, -  
         TABLE_DEFINITION=TEST_TBL.SQL)
```

This example produces the following control file. The control file is specific to a fixed length record text file. NULLs are handled by using the NULLIF clause for the column definition that references a corresponding null byte filler column. There is a null byte filler column for each column in the underlying table but not for the LogMiner specific columns at the beginning of the record. If a column is NULL, the corresponding RDB\$LM_NBn filler column is set to 1. VARCHAR columns are padded with blanks but the blanks are ignored by default when the file is loaded by SQL*Loader. If you wish to preserve the blanks, you can update the control file and add the "PRESERVE BLANKS" clause.

1.63 RMU Unload After_Journal Command

```
-- Control file for LogMiner transaction data 25-AUG-2000 12:15:50.47
-- From database table "TEST_DB"
LOAD DATA
INFILE 'DISK:[DIRECTORY]LOGMINER_TEXT.TXT;'
APPEND INTO TABLE 'RDB_LM_TEST_TBL'
(
RDB$LM_ACTION                POSITION(1:1) CHAR,
RDB$LM_RELATION_NAME         POSITION(2:32) CHAR,
RDB$LM_RECORD_TYPE           POSITION(33:44) INTEGER EXTERNAL,
RDB$LM_DATA_LEN              POSITION(45:50) INTEGER EXTERNAL,
RDB$LM_NBV_LEN               POSITION(51:56) INTEGER EXTERNAL,
RDB$LM_DBK                   POSITION(57:76) INTEGER EXTERNAL,
RDB$LM_START_TAD             POSITION(77:90) DATE "YYYYMMDDHHMISS",
RDB$LM_COMMIT_TAD            POSITION(91:104) DATE "YYYYMMDDHHMISS",
RDB$LM_TSN                   POSITION(105:124) INTEGER EXTERNAL,
RDB$LM_RECORD_VERSION        POSITION(125:130) INTEGER EXTERNAL,
TEST_COL                     POSITION(131:150) CHAR NULLIF RDB$LM_NB1 = 1,
RDB$LM_NB1                   FILLER POSITION(151:151) INTEGER EXTERNAL
)
```

Example 17

The following example creates a metadata file for the database MFP. This metadata file can be used as input to a later RMU Unload After_Journal command.

```
$ RMU /UNLOAD /AFTER_JOURNAL MFP /SAVE_METADATA=MF_MFP.METADATA /LOG
%RMU-I-LMMFWRTCNT, Wrote 107 objects to metadata file
"DUA0:[DB]MFMFP.METADATA;1"
```

Example 18

This example uses a previously created metadata information file for the database MFP. The database is not accessed during the unload operation; the database metadata information is read from the file. As the extract operation no longer directly relies on the source database, the AIJ and METADATA files can be moved to another systems and extracted there.

1.63 RMU Unload After_Journal Command

```
$ RMU /UNLOAD /AFTER_JOURNAL /RESTORE_METADATA=MF_MFP.METADATA -  
      MFP AIJ_BACKUP1 /TABLE=(NAME=TAB1, OUTPUT=TAB1) /LOG  
%RMU-I-LMMFRDCNT, Read 107 objects from metadata file  
      "DUA0:[DB]MF_MFP.METADATA;1"  
%RMU-I-UNLAIJFL, Unloading table TAB1 to DUA0:[DB]TAB1.DAT;1  
%RMU-I-LOGOPNAIJ, opened journal file DUA0:[DB]AIJ_BACKUP1.AIJ;1  
%RMU-I-AIJRSTSEQ, journal sequence number is "7216321"  
%RMU-I-AIJMODSEQ, next AIJ file sequence number will be 7216322  
%RMU-I-LOGSUMMARY, total 2 transactions committed  
%RMU-I-LOGSUMMARY, total 0 transactions rolled back  
-----  
      ELAPSED:  0 00:00:00.15 CPU: 0:00:00.01 BUFIO: 11 DIRIO: 5 FAULTS: 28  
Table "TAB1" : 1 record written (1 modify, 0 delete)  
Total : 1 record written (1 modify, 0 delete)
```

1.64 RMU Verify Command

1.64 RMU Verify Command

Checks the internal integrity of database data structures. The RMU Verify command does not verify the data itself. You can verify specific portions of a database or the integrity of routines stored in the database by using qualifiers.

Format

RMU/Verify root-file-spec

Command Qualifiers

/All
/Areas [= storage-area-list]
/Checksum_Only
/[No]Constraints = [(Options)]
/[No]Data
/End=page-number
/[No]Functions
/Incremental
/Indexes [= index-list]
/Lareas [= logical-area-list]
/[No]Log
/Output=file-spec
/[No]Root
/[No]Routines
/[No]Segmented_Strings
/Snapshots
/Start=page-number
/Transaction_Type=option

Defaults

See description
No Area checking performed
Full page verification
/NoConstraint
/Data when /Indexes is used
/End=last-page
/Nofunctions
See description
No index checking performed
No LAREA checking performed
Current DCL verify value
SYS\$OUTPUT
/Root
/Noroutines
See description
No snapshot verification
/Start=1
/Transaction_Type=Protected

If you specify the RMU Verify command without any qualifiers, a database root file verification and full page verification of the area inventory page (AIP) and the area bit map (ABM) pages in the default RDB\$SYSTEM storage area are performed. Also, the snapshot files and after-image journals are validated (even if journaling has been disabled).

The RMU Verify command checks space area management (SPAM) pages for proper format. The contents of the individual entries are verified as the individual data pages are verified. The command does not attempt to determine if data within rows is reasonable or plausible.

1.64 RMU Verify Command

Description

The RMU Verify command checks the internal integrity of database data structures. Oracle Corporation strongly recommends that you verify your database following any kind of serious system malfunction. You should also verify your database as part of routine maintenance, perhaps before performing backup operations. You can use the various qualifiers to perform verification of the maximum number of database areas in the time available.

Note

If you use the RMU Convert command with the Nocommit qualifier to convert a database created prior to Oracle Rdb Version 6.1, and then use the RMU Convert command with the Rollback qualifier to revert to the prior database structure level, subsequent verify operations might return an RMU-W-PAGTADINV warning message. See the Usage Notes section for details.

Command Parameters

root-file-spec

The Oracle Rdb database to verify. The default file extension is .rdb.

Command Qualifiers

All

When you specify the All qualifier, the entire database is checked, including any external routines. Specifying the All qualifier is equivalent to issuing the list of qualifiers shown in the following command:

```
$ RMU/VERIFY/ROOT/CONSTRAINTS/INDEXES/DATA/AREAS -  
_$_ /SNAPSHOTS/LAREAS/ROUTINES MF_PERSONNEL.RDB
```

If you do not specify the All qualifier, the verification requested by the other qualifiers you specify is performed.

See the Usage Notes entry in this command for the rules that determine which qualifiers can be used in combination on the same RMU Verify command line.

Areas[=storage-area-list]

Specifies the storage areas of the database to verify. You can specify storage areas by name or by the area's ID number. When you specify the storage area by name, each storage area name must be the name defined in the SQL CREATE STORAGE AREA statement for the storage area, not the storage

1.64 RMU Verify Command

area file name. If you list multiple storage areas, separate the storage area names or ID numbers with a comma, and enclose the storage area list within parentheses. The Areas qualifier with no arguments (or Areas=*) directs Oracle RMU to verify all storage areas of the database. With a single-file database, if you do not specify a storage area name, the RDB\$SYSTEM storage area is verified.

See the Usage Notes entry in this command for the rules that determine which qualifiers can be used in combination on the same RMU Verify command line.

The Areas qualifier can be used with indirect file references. See Section 1.3 for more information.

When the Areas qualifier is not specified, Oracle RMU does not verify any storage areas.

Checksum_Only

Specify with the Areas qualifier to perform only checksum verification of pages. This reduces the degree of verification done on a database page. While the RMU Verify command executes faster with the Checksum_Only qualifier than without it, it does not verify pages completely. This qualifier allows you to make trade-offs between speed of verification and thoroughness of verification. For more information on these trade-offs, see the *Oracle Rdb Guide to Database Maintenance*.

If this command finds a problem with a certain page, then that page can be verified in depth by using other qualifiers, such as Indexes, Areas, or Lareas.

Note that you can accomplish the same degree of verification during a backup operation by specifying the Checksum qualifier with the RMU Backup command. The advantage of specifying the Checksum qualifier with the RMU Backup command is that the checksum operation takes place concurrently with the backup operation.

See the Usage Notes entry in this command for the rules that determine which qualifiers can be used in combination on the same RMU Verify command line.

The default is for full verification of pages.

Constraints[=(Options)]

Noconstraints

Specifies which constraints Oracle RMU is to load and execute to check the integrity of data in the database. In addition, external routines (procedures and functions) referenced by constraints are activated and executed. Any exceptions produced cause the verify operation to report a failure. See the description of the routines qualifier for information on how routines are activated and executed.

1.64 RMU Verify Command

The options are as follows:

- **Tables=(list)**
Specifies the table for which constraints are to be checked. If you specify more than one table, separate each table name with a comma and enclose the list in parentheses. You can specify the wildcard character, the asterisk (*), instead of a table list to indicate that you want constraints checked for all tables in the database. This option is useful if you issued an RMU Load command with the Noconstraints qualifier.
- **Constraints=(list)**
Specifies the constraints which you want Oracle RMU to load and execute. If you specify more than one constraint, separate each constraint name with a comma and enclose the list in parentheses. You can specify the wildcard character, the asterisk (*), instead of a constraint list to indicate that you want all constraints checked for the database.
- **(Tables=(list), Constraints=(list))**
You can specify both the Tables and Constraints options to specify which combination of tables and constraints you want Oracle RMU to verify. If you specify the wildcard character, the asterisk (*), for the Tables option and a named constraint or constraints for the Constraint option within the same Oracle RMU command line, Oracle RMU verifies all constraints.

See the *Oracle Rdb Guide to Database Maintenance* for more information on verifying constraints.

See the Usage Notes entry in this command for the rules that determine which qualifiers can be used in combination on the same RMU Verify command line.

The default is the Noconstraints qualifier. When you specify the Noconstraints qualifier, Oracle RMU does not verify any constraints.

Data

Nodata

Specifies whether consistency checks are made between indexes and tables. When you specify the Data qualifier, Oracle RMU checks that every row to which an index points is a valid row for the table and it checks that every row in a table is pointed to by every index defined on the table. See the description of the Indexes qualifier for more information on how these comparisons are made.

The Data qualifier is valid only when it is used with the Indexes qualifier.

See the Usage Notes entry in this command for the rules that determine which qualifiers can be used in combination on the same RMU Verify command line.

1.64 RMU Verify Command

The default is the Data qualifier.

End=page-number

Specifies the last page to be verified. This qualifier is used in conjunction with the Areas and Lareas qualifiers. If you do not use the End qualifier, Oracle RMU verifies all pages between the first page (or the page specified in the Start qualifier) and the last page of the storage area.

The End qualifier is valid only when you specify the Areas or Lareas qualifier.

See the Usage Notes entry in this command for the rules that determine which other qualifiers can be used in combination on the same RMU Verify command line.

Functions

Nofunctions

This qualifier is synonymous with the Routines qualifier. See the description of the Routines qualifier.

Incremental

Directs Oracle RMU to verify database pages that have changed since the last full or incremental verification. Oracle RMU stores timestamps in the database root file for both full and incremental verifications. To determine which pages have changed since the last verify operation, Oracle RMU compares these timestamps with the page timestamps. The page timestamps are updated whenever pages are updated. An incremental verification performs the same number of I/O operations as a full verification, but the incremental verification takes fewer CPU cycles than a full verification, allowing you to perform incremental verifications more frequently than you would perform full ones. The default is to perform a full verification.

Note

If you use the Incremental qualifier with the RMU Verify command, Oracle Corporation recommends that you use it only with the All qualifier and not with any other qualifiers.

The timestamps in the database root file are updated during full and incremental verifications only when the All qualifier is specified. Therefore, if you do not specify the All qualifier, two successive incremental verifications of the same storage area of the database perform the same verifications. This means that the second incremental verification does not pass over pages verified by the first incremental verification, contrary to what you might expect.

1.64 RMU Verify Command

See the Usage Notes entry in this command for the rules that determine which qualifiers can be used in combination on the same RMU Verify command line.

If the Incremental qualifier is not specified, all requested pages are verified, regardless of the timestamp.

Indexes[=*index-list*]

Verifies the integrity of all but disabled indexes in the database if you specify the Indexes or the Indexes=* qualifier; verifies the integrity of a specific index, or of multiple indexes if you provide an index list. If you list multiple indexes, separate the index names with a comma, and enclose the index list within parentheses.

Beginning with Oracle Rdb V7.0, Oracle RMU uses a new method to verify indexes. In prior versions, the verify operation tried to retrieve the table row to which the index pointed. Beginning with Oracle Rdb V7.0, the verify operation creates a sorted list of all dbkeys for a table and a sorted list of all dbkeys in an index. By comparing these two lists, the verify operation can detect any cases of an index missing an entry for a data row. In addition, the verify operation runs faster. This comparison of dbkeys occurs at the end of the verify operation. If you specify the log qualifier, you see messages similar to the following to indicate that the comparison is occurring:

```
%RMU-I-IDXVERSTR, Index data verification of logical area  
60 (DEGREES) started.  
%RMU-I-IDXVEREND, Index data verification of logical area  
60 finished.
```

In addition, beginning in Oracle Rdb V7.0, when you verify an index with the Data qualifier (the default), Oracle RMU also verifies the logical areas referenced by the indexes. See Example 5 in the Examples section.

See the Usage Notes entry in this command for the rules that determine which qualifiers can be used in combination on the same RMU Verify command line.

By default, Oracle RMU does not verify indexes.

The Indexes qualifier can be used with indirect file references. See Section 1.3 for more information.

Lareas[=*logical-area-list*]

Specifies the storage area pages allocated to a logical area or logical areas that you want verified. If you list multiple logical areas, separate the logical area names with a comma, and enclose the logical area list within parentheses. The Lareas qualifier with no arguments (or Lareas=*) directs Oracle RMU to verify all logical areas of the database. When a logical area is verified, each page in the area is read and verified sequentially starting at the first page.

1.64 RMU Verify Command

If an index name is specified with the Lareas qualifier, the index is verified, but it is not verified as a logical area. In this case, the first index record is fetched (which could be on any page) and the verification follows the structure of the index. (For example, if the index record points to other index records, then those records are fetched and verified. If the index node is a leaf node, then the data record is fetched and verified. These data pages might reside in different logical areas.)

Use this qualifier to verify one or more tables.

See the Usage Notes entry in this command for the rules that determine which qualifiers can be used in combination on the same RMU Verify command line.

The Lareas qualifier can be used with indirect file references. See Section 1.3 for more information.

By default, Oracle RMU does not verify logical areas.

Log

Nolog

Specifies whether the processing of the command is reported to SYS\$OUTPUT. By default, SYS\$OUTPUT is your terminal. Specify the Log qualifier to request that each verify operation be displayed to SYS\$OUTPUT and the Nolog qualifier to prevent this display. If you specify neither, the default is the current setting of the DCL verify switch. (The DCL SET VERIFY command controls the DCL verify switch.)

When you specify the Log qualifier, Oracle RMU displays the time taken to verify each database area specified and the total time taken for the complete verification operation. The display from the Log qualifier is also useful for showing you how much of the verification operation is completed.

See the Usage Notes entry in this command for the rules that determine which qualifiers can be used in combination on the same RMU Verify command line.

Output=file-spec

Specifies the name of the file where output will be sent. The default is SYS\$OUTPUT. When you specify a file name, the default output file type is .lis.

If you specify both the Log qualifier and the Output qualifier, the messages produced by the Log qualifier and any error messages are directed into the output file specification. If you specify only the Output qualifier, only error messages are captured in the output file. See the Usage Notes entry in this command for the rules that determine which qualifiers can be used in combination on the same RMU Verify command line.

1.64 RMU Verify Command

Root

Noroot

Specifies that, in a multfile database, only fields in the database root (.rdb) file and all the pointers to the database (.rda, .snp, .aij) files are verified. The snapshot (.snp) files are validated; that is, only the first page is checked to make sure that it is indeed an .snp file and belongs to the database being verified. If after-image journaling is enabled, the .aij files are validated. The AIP and ABM pages are verified when you specify the Root qualifier.

If you specify the Noroot qualifier, and no other qualifiers, only the AIP pages are verified. If you specify the Noroot qualifier, and the Areas or the Lareas qualifier, ABM and SPAM pages are verified as the other pages in the storage area or logical area are verified.

See the Usage Notes entry in this command for the rules that determine which qualifiers can be used in combination on the same RMU Verify command line.

You can specify the Root qualifier for a single-file database.

The default is the Root qualifier.

Routines

Noroutines

The Routines qualifier verifies the integrity of all routine (function and procedure) definitions stored in the database. Oracle RMU performs the verification by activating and deactivating each external routine, one at a time. Any exceptions produced cause the verify operation to report a failure.

The Routines qualifier verifies that the shareable image is located where expected, is accessible, and that the correct entry point is at this location. The expected location is that which was specified in the SQL CREATE FUNCTION or CREATE PROCEDURE statement. If the shareable image is not in the expected location, is not accessible, or the entry point is not at the expected location, you receive an error message.

If Oracle RMU is installed with SYSPRV, any external routine image for a routine that is registered with client-site binding must meet the following criteria or the RMU Verify command cannot check for the existence of the entry point for the routine in the image:

- It must be installed.
- It must have been specified with an image file specification that uses only logicals defined with the DCL /SYSTEM and /EXECUTIVE qualifiers.

In addition, the user issuing the RMU Verify command must have OpenVMS SYSPRV in order for the routine to be activated.

1.64 RMU Verify Command

The Noroutines qualifier specifies that routine interface not be verified.

See the Usage Notes entry in this command for the rules that determine which qualifiers can be used in combination on the same RMU Verify command line.

By default, Oracle RMU does not verify any routines.

Segmented_Strings

Nosegmented_Strings

Verifies all list (segmented string) data for each column, in each table in any of the three types of storage areas: read/write and read-only (on read/write disk devices) and write-once (on WORM optical disk devices) in a database. When you specify the RMU Verify command with the All qualifier, all list data (segmented strings) in all tables is verified in the database. The Segmented_Strings qualifier can only be used with the Lareas qualifier and has the following meanings when used with this qualifier:

- RMU Verify command with the Lareas=* and the Segmented_Strings qualifiers.
Segmented strings in all tables are verified.
- RMU Verify command with the Lareas=(LAREA_1, . . . ,LAREA_N) and the Segmented_Strings qualifiers.

Segmented strings in tables LAREA_1, . . . ,LAREA_N are verified.

If the Segmented_Strings qualifier is omitted, there is no list data verification.

The Segmented_Strings qualifier verifies all list data in each column of each row in the database. The verify operation tries to fetch all pointer segments and all data segments from the pointer segments, and verifies all header information, including the total length of the segment, the number of pointer segments, the number of data segments, and the length of the longest segment for the list data.

Snapshots

Verifies the snapshot area of the specified storage areas up to the page header level. The Snapshots qualifier only performs checksum verification of snapshot pages.

The Snapshots qualifier is valid only when you also specify the Areas qualifier.

See the Usage Notes entry in this command for the rules that determine which other qualifiers can be used in combination on the same RMU Verify command line.

1.64 RMU Verify Command

The Snapshots qualifier can be used with indirect file references. See Section 1.3 for more information.

By default, Oracle RMU does not verify snapshots.

Start=page-number

Specifies the first page to be verified. This qualifier is used in conjunction with the Areas and Lareas qualifiers. If you do not use the Start qualifier, the verification begins with the first page of the storage area.

The Start qualifier is valid only when you specify the Areas or Lareas qualifier also.

See the Usage Notes entry in this command for the rules that determine which other qualifiers can be used in combination on the same RMU Verify command line.

Transaction_Type=option

Sets the retrieval lock for the storage areas being verified.

Use one of the following keywords to control the transaction mode:

- Automatic
When Transaction_Type=Automatic is specified, the transaction type depends on the current database settings for snapshots (enabled, deferred, or disabled), transaction modes available to this user, and the standby status of the database.
- Read_Only
Starts a Read_Only transaction.
- Exclusive
Starts a Read_Write transaction and reserves the table for Exclusive_Read.
- Protected
Starts a Read_Write transaction and reserves the table for Protected_Read. Protected mode is the default.
- Shared
Starts a Read_Write transaction and reserves the table for Shared_Read.

Use one of the following options with the keyword Isolation_Level=[option] to specify the transaction isolation level:

- Read_Committed
- Repeatable_Read

1.64 RMU Verify Command

- **Serializable.** Serializable is the default setting.

Refer to the SET TRANSACTION statement in the Oracle Rdb SQL Reference Manual for a complete description of the transaction isolation levels.

Specify the wait setting by using one of the following keywords:

- **Wait**
Waits indefinitely for a locked resource to become available. Wait is the default behavior.
- **Wait=n**
The value you supply for *n* is the transaction lock timeout interval. When you supply this value, Oracle Rdb waits *n* seconds before aborting the wait and the RMU Verify session. Specifying a wait timeout interval of zero is equivalent to specifying Nowait.
- **Nowait**
Does not wait for a locked resource to become available.

See the Usage Notes entry in this command for the rules that determine which qualifiers can be used in combination on the same RMU Verify command line.

Usage Notes

- To use the RMU Verify command for a database, you must have the RMU\$VERIFY privilege in the root file access control list (ACL) for the database or the OpenVMS SYSPRV or BYPASS privilege. You must also have the SQL DBADM privilege.
- The rules that determine which qualifiers can be used in combination on the same RMU Verify command line are as follows:
 - The Incremental, Log, Output, and Transaction_Type qualifiers can be used in combination with any other qualifiers on the same RMU Verify command line.
 - If the All qualifier is specified, the only other qualifiers you can specify on the same command line are:
 - * Noroutines (or Nofunctions)
 - * Nosegmented_Strings

1.64 RMU Verify Command

- If the All qualifier is *not* specified, then any combination of the following qualifiers can be specified on the same command line:
 - * Areas
 - * Constraints
 - * [No]Functions
 - * Indexes
 - * Lareas
 - * [No]Root
 - * [No]Routines
- You must specify the Areas qualifier to specify the Checksum_Only or Snapshots qualifier.
- You must specify the Lareas qualifier to specify the Segmented_Strings qualifier.
- You must specify either the Areas or Lareas qualifier to specify the Start and End qualifiers.
- You cannot specify the Indexes qualifier on the same RMU Verify command line with the Start and End qualifiers.
- You must specify the Indexes qualifier to specify the [No]Data qualifier.
- You can significantly improve the performance of RMU Verify for your database by employing the verification strategies described in the *Oracle Rdb Guide to Database Maintenance*. In addition, detected asynchronous prefetch should be enabled to achieve the best performance of this command. Beginning with Oracle Rdb V7.0, by default, detected asynchronous prefetch is enabled. You can determine the setting for your database by issuing the RMU Dump command with the Header qualifier.
If detected asynchronous prefetch is disabled, and you do not want to enable it for the database, you can enable it for your Oracle RMU operations by defining the following logicals at the process level:

```
$ DEFINE RDM$BIND_DAPF_ENABLED 1  
$ DEFINE RDM$BIND_DAPF_DEPTH_BUF_CNT P1
```

P1 is a value between 10 and 20 percent of the user buffer count.

1.64 RMU Verify Command

- If you use the RMU Convert command with the Nocommit qualifier to convert a database created prior to Oracle Rdb Version 6.0, and then use the RMU Convert command with the Rollback qualifier to revert to the previous database structure level, subsequent RMU Verify commands might produce messages such as the following:

```
%RMU-W-PAGTADINV, area RDB$SYSTEM, page 1
      contains incorrect time stamp
      expected between 14-APR-1992 15:55:25.74
      and 24-SEP-1993 13:26:06.41, found:
```

Beginning in Oracle Rdb Version 6.0, the fast incremental backup feature alters the page header of updated SPAM pages to record which page ranges have been updated since the previous full backup operation. The RMU Verify command in versions of Oracle Rdb prior to Version 6.0 does not contain code to understand the updated page header and issues the PAGTADINV warning when encountering an updated SPAM page header. The update page headers are only detected by the RMU Verify command and do not affect the run-time operation of Oracle Rdb. To correct the updated SPAM pages, you can use the RMU Repair command with the Spams qualifier as follows:

```
$ RMU/VERIFY/ALL/NOLOG MF_PERSONNEL
%RMU-W-PAGTADINV, area RDB$SYSTEM, page 1
      contains incorrect time stamp
      expected between 14-APR-1992 15:55:25.74
      and 24-SEP-1993 13:26:06.41, found:
$
$ RMU/REPAIR/SPAMS MF_PERSONNEL
%RMU-I-FULBACREQ, A full backup of this database should be performed
  after RMU/REPAIR
$
$ RMU/VERIFY/ALL/NOLOG MF_PERSONNEL
$
```

- The RMU Verify command ignores any constraint that has been disabled (with the SQL ALTER TABLE enable-disable clause) unless you specify the constraint name in the Constraints=(Constraints=list) qualifier of the RMU Verify command. If the Constraints qualifier is specified without a list, disabled constraints are ignored.

By specifying the name of a disabled constraint in the Constraints=(Constraints=list) qualifier, you can check it periodically without having to reenable it. You might use this to provide a business rule in the database that needs checking only occasionally. This is a useful practice if the overhead of checking the constraint during operating hours is too expensive, or if it is already being enforced by the application.

1.64 RMU Verify Command

- The number of work files used by the RMU Verify command is controlled by the RDM\$BIND_SORT_WORKFILES logical name. The allowable values are 1 through 10 inclusive, with a default value of 2. The location of these work files can be specified with device specifications, using the SORTWORKn logical name (where *n* is a number from 0 to 9). See the OpenVMS documentation set for more information on using SORT/MERGE. See the *Oracle Rdb7 Guide to Database Performance and Tuning* for more information on using these Oracle Rdb logical names.

Because two separate sort streams are used internally by the RMU Verify command when the Index qualifier is specified, the number of work files specified is used for each stream. For example, if RDM\$BIND_SORT_WORKFILES is defined to be 10, twenty work files are created.

Examples

Example 1

The following command verifies the entire mf_personnel database because the All qualifier is specified:

```
$ RMU/VERIFY/ALL/LOG MF_PERSONNEL.RDB
```

Example 2

The following command verifies the storage areas EMPIDS_LOW, EMPIDS_MID, and EMPIDS_OVER in the mf_personnel database:

```
$ RMU/VERIFY/AREAS=(EMPIDS_LOW,EMPIDS_MID,EMPIDS_OVER)/LOG -  
_ $ MF_PERSONNEL.RDB
```

Example 3

The following command performs only a checksum verification on all the storage areas in the database called large_database. The Checksum_Only qualifier quickly detects obvious checksum problems with the database. If a checksum problem is found on a page, you can dump the page by using the RMU Dump command, and verify the appropriate logical areas and indexes.

```
$ RMU/VERIFY/AREAS=*/CHECKSUM_ONLY/LOG LARGE_DATABASE
```

Example 4

The following command verifies the Candidates and Colleges tables:

```
$ RMU/VERIFY/LAREAS=(CANDIDATES, COLLEGES)/LOG MF_PERSONNEL.RDB
```

1.64 RMU Verify Command

Example 5

The following example displays the behavior of the index verification method Oracle RMU employs beginning in Oracle Rdb V7.0. The first RMU Verify command shows the log output when the command is issued under Oracle Rdb V6.1. The second RMU Verify command shows the log output when the command is issued under Oracle Rdb V7.0.

```
$ @SYS$LIBRARY:RDB$SETVER 6.1
$ SET DEF DB1:[V61]
$ RMU/VERIFY/INDEXES=EMP_EMPLOYEE_ID/DATA MF_PERSONNEL.RDB/LOG
%RMU-I-BGNROOVER, beginning root verification
%RMU-I-ENDROOVER, completed root verification
%RMU-I-DBBOUND, bound to database "DB1:[V61]MF_PERSONNEL.RDB;1"
%RMU-I-OPENAREA, opened storage area RDB$SYSTEM for protected retrieval
%RMU-I-BGNAIPVER, beginning AIP pages verification
%RMU-I-ENDAIPVER, completed AIP pages verification
%RMU-I-BGNABMSPM, beginning ABM pages verification
%RMU-I-OPENAREA, opened storage area MF_PERS_SEGSTR for protected retrieval
%RMU-I-ENDABMSPM, completed ABM pages verification
%RMU-I-BGNNDXVER, beginning verification of index EMP_EMPLOYEE_ID
%RMU-I-OPENAREA, opened storage area EMPIDS_LOW for protected retrieval
%RMU-I-OPENAREA, opened storage area EMPIDS_MID for protected retrieval
%RMU-I-OPENAREA, opened storage area EMPIDS_OVER for protected retrieval
%RMU-I-ENDNDXVER, completed verification of index EMP_EMPLOYEE_ID
%RMU-I-CLOSAREAS, releasing protected retrieval lock on all storage areas
%RMU-S-ENDVERIFY, elapsed time for verification :    0 00:00:09.14
$ @SYS$LIBRARY:RDB$SETVER 7.0
$ SET DEF DB1:[V70]
$ RMU/VERIFY/INDEXES=EMP_EMPLOYEE_ID/DATA MF_PERSONNEL.RDB/LOG
%RMU-I-BGNROOVER, beginning root verification
%RMU-I-ENDROOVER, completed root verification
%RMU-I-DBBOUND, bound to database "DB1:[V70]MF_PERSONNEL.RDB;1"
%RMU-I-OPENAREA, opened storage area RDB$SYSTEM for protected retrieval
%RMU-I-BGNAIPVER, beginning AIP pages verification
%RMU-I-ENDAIPVER, completed AIP pages verification
%RMU-I-BGNABMSPM, beginning ABM pages verification
%RMU-I-ENDABMSPM, completed ABM pages verification
%RMU-I-BGNNDXVER, beginning verification of index EMP_EMPLOYEE_ID
%RMU-I-OPENAREA, opened storage area EMPIDS_LOW for protected retrieval
%RMU-I-OPENAREA, opened storage area EMPIDS_MID for protected retrieval
%RMU-I-OPENAREA, opened storage area EMPIDS_OVER for protected retrieval
%RMU-I-ENDNDXVER, completed verification of index EMP_EMPLOYEE_ID
```

1.64 RMU Verify Command

```
%RMU-I-BSGPGLARE, beginning verification of EMPLOYEES logical area
                    as part of EMPIDS_LOW storage area
%RMU-I-ESGPGLARE, completed verification of EMPLOYEES logical area
                    as part of EMPIDS_LOW storage area
%RMU-I-BSGPGLARE, beginning verification of EMPLOYEES logical area
                    as part of EMPIDS_MID storage area
%RMU-I-ESGPGLARE, completed verification of EMPLOYEES logical area
                    as part of EMPIDS_MID storage area
%RMU-I-BSGPGLARE, beginning verification of EMPLOYEES logical area
                    as part of EMPIDS_OVER storage area
%RMU-I-ESGPGLARE, completed verification of EMPLOYEES logical area
                    as part of EMPIDS_OVER storage area
%RMU-I-IDXVERSTR, Beginning index data verification of logical area 69
                    (EMPLOYEES).
%RMU-I-IDXVEREND, Completed data verification of logical area 69.
%RMU-I-IDXVERSTR, Beginning index data verification of logical area 70
                    (EMPLOYEES).
%RMU-I-IDXVEREND, Completed data verification of logical area 70.
%RMU-I-IDXVERSTR, Beginning index data verification of logical area 71
                    (EMPLOYEES).
%RMU-I-IDXVEREND, Completed data verification of logical area 71.
%RMU-I-CLOSAREAS, releasing protected retrieval lock on all storage areas
%RMU-S-ENDVERIFY, elapsed time for verification :    0 00:00:11.36
```

Example 6

The following example loads data into a table, verifies the table, and then identifies loaded rows that violated a constraint.

Because the Noconstraints qualifier is specified with the RMU Load command, data that violates database integrity might be added to the database. The second RMU Verify command verifies the table that was just loaded and reveals that data that violates constraints on the table was indeed loaded.

An SQL command is issued to determine which rows violated the constraint so that they can either be removed from the database, or added to the EMPLOYEES table to restore database integrity. The final RMU Verify command checks the constraint again to ensure that changes made have restored the integrity of the database.

1.64 RMU Verify Command

```
$ !
$ ! Load data into the JOB_HISTORY table of the mf_personnel database.
$ ! Specify the Noconstraints qualifier:
$ !
$ RMU/LOAD/RECORD_DEFINITION=(FILE=JOB_HIST.RRD, FORMAT=TEXT) -
_$ MF_PERSONNEL.RDB JOB_HISTORY JOB_HIST.UNL/NOCONSTRAINTS
%RMU-I-DATRECREAD, 18 data records read from input file.
%RMU-I-DATRECSTO, 18 data records stored.
$ !
$ ! Verify the JOB_HISTORY table:
$ !
$ RMU/VERIFY/CONSTRAINTS=(TABLE=JOB_HISTORY) MF_PERSONNEL.RDB
%RMU-W-CONSTFAIL, Verification of constraint "JOB_HISTORY_FOREIGN1"
has failed.
$ !
$ ! Issue SQL statements to determine what the definition of the
$ ! constraint is and which of the loaded rows violated
$ ! the constraint. Then issue an SQL command to insert data that will
$ ! restore the data integrity of the database:
$ SQL
SQL> ATTACH 'FILENAME MF_PERSONNEL.RDB';
SQL> SHOW TABLE JOB_HISTORY
.
.
.
JOB_HISTORY_FOREIGN1
Foreign Key constraint
Column constraint for JOB_HISTORY.EMPLOYEE_ID
Evaluated on COMMIT
Source:
        JOB_HISTORY.EMPLOYEE_ID REFERENCES EMPLOYEES (EMPLOYEE_ID)
.
.
.
SQL> SELECT DISTINCT(EMPLOYEE_ID)
cont> FROM JOB_HISTORY
cont> WHERE NOT EXISTS
cont>         (SELECT *
cont>          FROM EMPLOYEES AS E
cont>          WHERE E.EMPLOYEE_ID = JOB_HISTORY.EMPLOYEE_ID);
EMPLOYEE_ID
10164
10165
10166
10167
10168
10169
6 rows selected
SQL> INSERT INTO EMPLOYEES (EMPLOYEE_ID, LAST_NAME)
cont> VALUES ('10164', 'Smith');
SQL> INSERT INTO EMPLOYEES (EMPLOYEE_ID, LAST_NAME)
cont> VALUES ('10165', 'Frederico');
```

1.64 RMU Verify Command

```
SQL> INSERT INTO EMPLOYEES (EMPLOYEE_ID, LAST_NAME)
cont> VALUES ('10166', 'Watts');
SQL> INSERT INTO EMPLOYEES (EMPLOYEE_ID, LAST_NAME)
cont> VALUES ('10167', 'Risley');
SQL> INSERT INTO EMPLOYEES (EMPLOYEE_ID, LAST_NAME)
cont> VALUES ('10168', 'Pietryka');
SQL> INSERT INTO EMPLOYEES (EMPLOYEE_ID, LAST_NAME)
cont> VALUES ('10169', 'Jussaume');
SQL> COMMIT;
SQL> EXIT
$ !
$ ! Check that data integrity has been restored:
$ !
$ RMU/VERIFY/CONSTRAINTS=(CONSTRAINTS=JOB_HISTORY_FOREIGN1, -
_$ TABLE=JOB_HISTORY) MF_PERSONNEL.RDB
$ !
$ ! No messages are returned. Data integrity has been restored.
```

Example 7

The following example creates an external function in which the external name is incorrect. When the function is verified, Oracle RMU cannot find the entry point and returns an error. The external function is then dropped and then re-created correctly. The verification now succeeds:

```
$ ! Attach to database and create a function. The external name is
$ ! mistyped:
$ !
SQL> ATTACH 'filename mf_personnel.rdb';
SQL> create function SQRT (in double precision) returns double precision;
cont> external name MTH$SORT location 'SYS$SHARE:MTHRTL'
cont> language GENERAL
cont> GENERAL PARAMETER STYLE;
SQL> COMMIT;
SQL> EXIT;
$ !
$ ! Verify the function:
$ !
$ RMU/VERIFY/ROUTINES MF_PERSONNEL.RDB
%RMU-E-NOENTRPT, No entry point found for external routine SQRT.
      Image name is SYS$SHARE:MTHRTL.
      Entry point is MTH$SORT.
```

1.64 RMU Verify Command

```
$ !
$ ! Oracle RMU cannot find the entry point. Drop the
$ ! function and reenter correctly:
$ !
$ SQL
SQL> ATTACH 'FILENAME mf_personnel.rdb';
SQL> DROP FUNCTION SQRT;
SQL> create function SQRT (in double precision) returns double precision;
cont> external name MTH$SQRT location 'SYS$SHARE:MTHRTL'
cont> language GENERAL
cont> GENERAL PARAMETER STYLE;
SQL> COMMIT;
SQL> EXIT;
$ !
$ ! Verification is now successful:
$ !
$ RMU/VERIFY/ROUTINES MF_PERSONNEL.RDB
```

Example 8

The following example demonstrates that the RMU Verify command verifies disabled constraints only when you explicitly specify the disabled constraint.

```
$ SQL
SQL> ATTACH 'FILENAME MF_PERSONNEL.RDB';
SQL> -- Disable the EMP_SEX_VALUES constraint.
SQL> ALTER TABLE EMPLOYEES DISABLE CONSTRAINT EMP_SEX_VALUES;
SQL> COMMIT;
SQL> -- Insert a value that violates the EMP_SEX_VALUES constraint.
SQL> INSERT INTO EMPLOYEES
cont> (EMPLOYEE_ID, LAST_NAME, SEX)
cont> VALUES ('99999', 'JICKLING', 'G');
1 row inserted
SQL> COMMIT;
SQL> EXIT;
$ !
$ ! The following two verify commands do not return an error
$ ! because the disabled constraint is not explicitly specified.
$ !
$ RMU/VERIFY MF_PERSONNEL.RDB
$ RMU/VERIFY MF_PERSONNEL.RDB/CONSTRAINTS
$ !
$ ! The following verify command returns an warning message to
$ ! inform you that data that violates the disabled constraint
$ ! has been inserted into the database.
$ !
$ RMU/VERIFY MF_PERSONNEL.RDB/CONSTRAINT=(CONSTRAINT=EMP_SEX_VALUES)
%RMU-W-CONSTFAIL, Verification of constraint "EMP_SEX_VALUES" has failed.
```

RdbALTER Utility Command Syntax

This chapter describes the RdbALTER utility for Oracle Rdb. The RdbALTER utility provides a low-level patch capability that allows you to repair corruption on Oracle Rdb database pages. In addition, it allows you to relocate database root, storage area, and snapshot files to other disks or directories. This is helpful when you move a database from a single node to a clustered environment.

Note

Oracle Corporation recommends that the RdbALTER utility be used only to provide a temporary patch to a corrupt database. The RdbALTER utility should not be used as a routine database management tool.

Use the RdbALTER utility only after you fully understand the internal data structure, know the information the database should contain, and know the full effects of the command. Because of the power of the RdbALTER utility and the cascading effects it can have, Oracle Corporation recommends that you experiment on a copy of the damaged database before applying the RdbALTER utility to a production database.

Issue the RMU Alter command using the following format:

```
$ RMU/ALTER [root-file-spec]
```

The optional root-file-spec parameter identifies the database you want to alter. If you specify this parameter, you automatically attach to the specified database. If you do not specify this parameter, you must use the RdbALTER ATTACH command. See Section 2.2 for more information on the ATTACH command.

To use the RMU Alter command for a database, you must have the RMU\$ALTER privilege in the root file access control list (ACL) for the database or the OpenVMS SYSPRV or BYPASS privilege.

If you are using an RMU Alter command to change a file name, you *must* have the OpenVMS SYSPRV or BYPASS privilege.

The RMU Alter command responds with the following prompt:

```
RdbALTER>
```

This prompt indicates that the system expects RdbALTER command input. The RdbALTER commands are:

- AREA . . . PAGE
- ATTACH
- COMMIT
- DEPOSIT
- DEPOSIT FILE
- DEPOSIT ROOT
- DETACH
- DISPLAY
- DISPLAY FILE
- DISPLAY ROOT
- EXIT
- HELP
- LOG
- MAKE CONSISTENT
- MOVE
- NOLOG
- PAGE
- RADIX
- ROLLBACK
- UNCORRUPT
- VERIFY

When you invoke RdbALTER and the database needs to be recovered, RdbALTER displays a message to that effect. If you receive this message, you should recover the database and verify it before making any changes in RdbALTER. If you make changes in RdbALTER before recovering the database, the recovery procedure may write over your changes.

After you have successfully completed making changes with RdbALTER, you should issue an RMU Backup command. RdbALTER commands are not recorded in the after-image journal (.aij) file, so it will not be possible to recover any changes made with RdbALTER should a database failure occur.

RdbALTER can receive command lines through command files or directly from your terminal.

You can abbreviate any of the RdbALTER command keywords. The only restriction is that you specify enough characters to avoid ambiguity.

RdbALTER interprets the exclamation point (!) as a comment character. If you want RdbALTER to disregard a line of characters, start the line with an exclamation point.

The remainder of this chapter describes the full syntax and usage of these commands. For detailed information on using the RdbALTER utility, see the *Oracle Rdb Guide to Database Maintenance*.

2.1 AREA . . . PAGE Command

2.1 AREA . . . PAGE Command

Specifies a storage area, a snapshot area, or a page in an area of the database to which you are currently attached.

Description

Only one page of one area is accessible to RdbALTER at a time. This command switches you from one page of the currently attached database to another page.

When you attach to a database, RdbALTER automatically makes area 1 the current area and page 1 of that area the current page. To work on any other area and page, you must use the AREA . . . PAGE command.

If you specify AREA but not PAGE, RdbALTER makes the area you specify current and fetches page 1 of that area.

If you specify both AREA and PAGE, RdbALTER makes the area you specify current and fetches the page you specify from the new current area.

If you specify an area or page that does not exist, an error occurs and the current area and page do not change.

Use the PAGE option to switch from one page in the current area to another page in the current area.

Format

AREA → storage-area-name
 → area-number → PAGE page-number

Command Parameters

storage-area-name

Specifies a storage area of the current database by the storage area name, which is the name defined in the SQL CREATE STORAGE AREA statement. To specify a snapshot area, use the area-number parameter.

area-number

Specifies a storage area or snapshot area of the current database by the area number, which is assigned when the database is created and is given on the first line of a page display.

2.1 AREA . . . PAGE Command

page-number

Identifies the area page to be altered. Express it as an integer from 1 to the number of pages in the area.

Examples

Example 1

The following example specifies the area JOBS of the currently attached database. No page number has been specified, so RdbALTER fetches page 1 of the area.

```
RdbALTER> AREA JOBS
```

Example 2

The following example is similar to Example 1, except it specifies the area by its area number instead of its area name. If area 4 is the area named JOBS in the database, either command produces the same result.

```
RdbALTER> AREA 4
```

Example 3

The following example fetches area 3, page 100:

```
RdbALTER> AREA 3 PAGE 100
```

2.2 ATTACH Command

2.2 ATTACH Command

Attaches RdbALTER to a database, putting an exclusive update lock on the database. No other user can access the database while the RdbALTER ATTACH command is in effect.

The database specified by the root-file-spec parameter is attached to RdbALTER. Then you can alter the pages of its storage area files. Area 1, page 1 of the database is fetched automatically and remains the current page until you issue an AREA . . . PAGE command.

Description

If the RMU Alter command includes a root-file-spec parameter, the database to which this root-file-spec refers is attached to as part of the RdbALTER startup. In this case, the ATTACH command is unnecessary. Otherwise, no commands changing database pages are allowed until an ATTACH command naming that database is issued.

You can use the ATTACH command to attach to only one database at a time. Before invoking another database for altering, you must use the DETACH command to detach from the current database. See Section 2.7 for more information on the DETACH command.

Format

`ATTACH` → `root-file-spec` →

Command Parameters

root-file-spec

Specifies the database root (.rdb) file whose pages you want to alter. The default file type is .rdb.

Examples

Example 1

The following example enters RdbALTER command level, and then attaches to the PERSONNEL database:

```
$ RMU/ALTER
RdbALTER> ATTACH PERSONNEL
%RMU-I-ATTACH, now altering database "DISK:[USER]PERSONNEL.RDB;1"
```

2.2 ATTACH Command

Example 2

The following example enters RdbALTER command level and attaches to the PERSONNEL database, using a single command:

```
$ RMU/ALTER PERSONNEL
%RMU-I-ATTACH, now altering database "DISK:[USER]PERSONNEL.RDB;1"
```

2.3 COMMIT Command

2.3 COMMIT Command

Writes all page changes back to the database since the last COMMIT or last ROLLBACK command was entered.

Description

The results of DEPOSIT and MOVE commands are kept in virtual memory until you issue a COMMIT or a ROLLBACK command. When you issue a COMMIT command, all pages that you changed since the last COMMIT or last ROLLBACK command are written to the database in their new form.

Changes are not permanent until you issue a COMMIT command. If you issue an EXIT command while altered but uncommitted pages exist, an error results. You cannot issue the EXIT command until you first issue either a COMMIT or a ROLLBACK command.

Oracle Corporation recommends that you make a backup copy of the database after you issue the RdbALTER COMMIT command.

Format

COMMIT →

Examples

Example 1

The following example commits all page changes entered since the last COMMIT or last ROLLBACK command:

```
RdbALTER> COMMIT
```

2.4 DEPOSIT Command

Alters specified data fields on the current database page.

Description

The DEPOSIT command is the default at RdbALTER command level. If no other command is present following the prompt, RdbALTER automatically parses the command line as a DEPOSIT command.

The specification of the field to be altered must be followed by an equal sign (=) and a string of characters specifying the new value of the altered field.

Do not use the DEPOSIT command immediately after a ROLLBACK command. The ROLLBACK command removes current page context. If you issue a DEPOSIT command immediately after a ROLLBACK command, a warning message is returned indicating that there is no current page. For this reason, you must specify your location again by using either the DISPLAY or the AREA . . . PAGE command immediately after a ROLLBACK command but before a DEPOSIT command.

Format

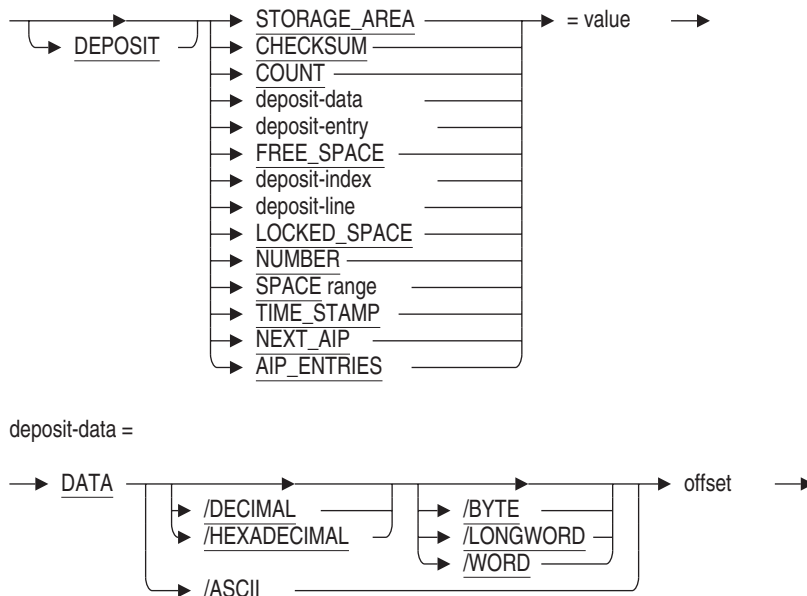

2.4 DEPOSIT Command

deposit-entry =

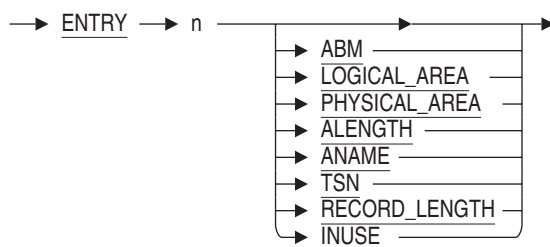

deposit-index =

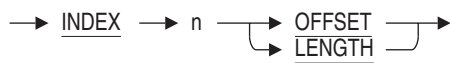

deposit-line =



range =

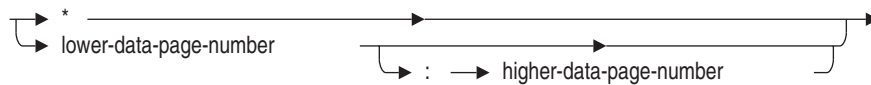

Command Parameters

STORAGE_AREA

Deposits a value for the 2-byte storage area identification.

CHECKSUM

Deposits a value for the 4-byte page checksum field.

COUNT

Deposits a value for the 2-byte field showing the number of line index entries. If this number is 1, the page contains only the SYSTEM record.

DATA offset

Deposits the number of bytes specified. If you do not specify the HEXADECIMAL or the DECIMAL qualifier, the default radix is assumed.

2.4 DEPOSIT Command

See Section 2.18 for information on how to set a default radix with the RADIX command.

The BYTE, LONGWORD, and WORD qualifiers cannot be used with the ASCII qualifier.

ENTRY

Refers to an area inventory page (AIP) entry on the database page. The value specified for *n* must be a number between zero and the number of AIP entries.

ABM

Deposits the new value on the first area bit map (ABM) page for the specified AIP entry. The ABM value is contained in a longword.

LOGICAL_AREA

Deposits the new value for the number of the logical area for the AIP entry. The LOGICAL_AREA value is contained in a word.

PHYSICAL_AREA

Deposits the new value for the number of the physical area for the AIP entry. The PHYSICAL_AREA value is contained in a word.

ALENGTH

Deposits the new value for the length of the name of the logical area for the AIP entry. The ALENGTH value is contained in 1 byte. The name of the logical area can be from 1 to 31 bytes in length.

ANAME

Deposits the new value for the name of the logical area for the AIP entry. The ANAME value is contained in a 31-character text field.

TSN

Deposits a value for the last transaction sequence number (TSN) to enable snapshot (.snp) files for the logical area of the AIP entry.

Note

Beginning in Oracle Rdb V7.0, Oracle Rdb stores any transaction sequence number that is larger than a longword by using both the TSN field on the page and the page TSN base. Oracle Rdb calculates the actual TSN by applying a formula to these two values. Oracle Corporation recommends that you do not change a TSN value that is larger than a longword. When a TSN is larger than a longword, a nonzero number is stored in the page TSN base (the page tail). The

2.4 DEPOSIT Command

following example shows the location of the page TSN and the page TSN base:

```
000A 00000003 0000 page 3, physical area 10
      9D091204 0006 checksum = 9D091204
009A2C0F ED786D2E 000A time stamp = 23-MAY-1996 09:08:53.36
      0000 03C4 0012 964 free bytes, 0 locked
      0001 0016 1 line
      0005 03E4 0018 line 0: offset 03E4, 5 bytes
page TSN -----> 00000000 001C line 0: TSN 0
.
.
.
      2001 03E4 line 0 (10:3:0) SYSTEM record
      00 0001 03E6 1 byte in 0 sets/dynamic items
0000000000 03E9 padding '.....'
      FFFFFFFF 03EE snap page pointer -1
      00000000 03F2 snap pointer TSN 0
      0000 03F6 MBZ '..'
      00000000 03F8 page sequence number 0
page TSN base -----> 0000 03FC page TSN base 0
      0000 03FE MBZ '..'
```

RECORD_LENGTH

Deposits a value for the length, in bytes, of the record size for an AIP entry. The RECORD_LENGTH value is contained in a word.

INUSE

Deposits the new value for the AIP entry's in-use flag. The INUSE value is contained in 1 byte.

FREE_SPACE

Deposits a value for the 2-byte field indicating how much free space remains on the page.

Note

In the next two parameters, the integers denoting INDEX and LINE are zero based. For example, INDEX 0 refers to the first index, and LINE 3 refers to the fourth line.

References to INDEX and LINE are invalid if the current page is a space area management (SPAM) page, an AIP page, or an ABM page.

2.4 DEPOSIT Command

INDEX *n*

Deposits a value for the offset field or the length field for the line index indicated by *n*. For example, if you enter DEPOSIT INDEX 3 OFFSET, the offset address field from the fourth-line index is deposited.

LINE *n*

Deposits information for an individual storage segment. You can deposit a value for the RECORD_TYPE field.

LOCKED_SPACE

Deposits a value for the 2-byte field indicating how much free space is allocated for exclusive use by a recovery unit.

NUMBER

Deposits a value for the 4-byte page number field.

SPACE range

Deposits a value for a specified range of SPAM entries; it is valid only if the current page is a SPAM page. (The SPACE and DATA parameters are the only ones that you can use in DISPLAY and DEPOSIT commands that access a SPAM page.) The range value can be an asterisk (*), referring to all entries, or a set of consecutive entries, which you describe as follows:

```
lower-data-page-number[:higher-data-page-number]
```

Each entry on a SPAM page consists of 2 bits, containing a value 0 through 3 that represents a fullness threshold. For example, if the *n*th SPAM entry contains a 2, it means that the *n*th data page in the interval has reached a percentage of fullness greater than the second threshold for the area, but less than or equal to the third threshold.

TIME_STAMP

Deposits a value for the 8-byte time and date stamp field.

NEXT_AIP

Deposits a value for the page number of the next area inventory page (AIP).

AIP_ENTRIES

Deposits a value for the number of area inventory page (AIP) entries on the current area inventory page.

value

Specifies the new value of the field you are altering. The value is deposited in the default radix unless you specify otherwise in one of these ways:

- With a prior RADIX command.

2.5 DEPOSIT FILE Command

Puts a new file specification into the database root (.rdb) file for a storage area (.rda) or snapshot (.snp) file.

Format

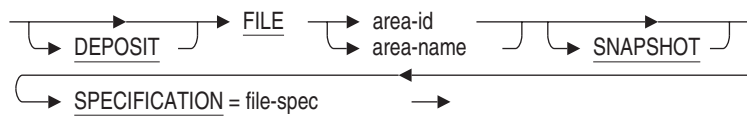

Command Parameters

area-id

Specifies the number of the .rda or .snp file whose file specification you are changing in the .rdb file.

area-name

Specifies the name of the .rda or .snp file whose file specification you are changing in the .rdb file.

SNAPSHOT

Specifies that the file whose .rdb file fields you are changing is an .snp file.

SPECIFICATION = file-spec

Specifies the file specification that the .rda or .snp file will have. Use a full file specification (including version number) if the .rda or .snp file is not in your default directory. The file must be in the location you specify, otherwise the DEPOSIT FILE command fails.

Examples

Example 1

The following example deposits a new file specification for the JOBS storage area file. The word (*marked*) in the DEPOSIT FILE display indicates that the JOBS storage area file is marked for the specified location.

2.5 DEPOSIT FILE Command

```
RdbALTER> DISPLAY FILE JOBS
Area JOBS:
    File specification is: "DISK1:[RICK.RDB]JOBS.RDA;1"
    Corrupt flag is: OFF
    Inconsistent flag is: OFF

RdbALTER> DEPOSIT FILE JOBS SPECIFICATION=DISK1:[RICK]JOBS.RDA;1
Area JOBS:
(marked) File specification is: "DISK1:[RICK]JOBS.RDA;1"
```

See the *Oracle Rdb Guide to Database Maintenance* for more examples of how to use the DEPOSIT FILE command.

2.6 DEPOSIT ROOT Command

2.6 DEPOSIT ROOT Command

Enters new file specifications for database files. The file specification you enter will be the file specification after the change is committed to the database. The change does not occur until you have committed all changes and ended the RdbALTER session.

Note

Prior to Oracle Rdb Version 6.0, you could use the DEPOSIT ROOT command to alter an after-image journal (.aij) file name. This is no longer an option; use the RMU Set After_Journal command instead.

Description

The default is DEPOSIT ROOT SPECIFICATION if no other keyword follows the DEPOSIT ROOT command.

The DEPOSIT ROOT command allows a user to remove recovery-unit journal (.ruj) file references from the database root (.rdb) file, allowing access to the database. However, this action will mark the database as “eternally corrupt,” which results in a warning message in all future system management (Oracle RMU) functions against the database. The database is either structurally corrupt, logically corrupt (violates a constraint), or “user-data” corrupt (for example, balance is \$250.00 instead of \$300.00).

Removing the .ruj file references from the .rdb file permits users to attach to the database in situations where the .ruj files have been accidentally deleted. Users must realize that the database is corrupt when they attach. The database must be restored and recovered from clean backup files to guarantee the consistency of the database contents.

Use the USER n RUJ_FILENAME="" clause to remove an .ruj file reference from the .rdb file.

Note

After you commit a changed .rdb file name, the database cannot be accessed until you copy it to the location (using all the necessary qualifiers for the file specification) that you specify with the DEPOSIT

2.6 DEPOSIT ROOT Command

ROOT command. After that, users attach to the database at the new location.

Format



Command Parameters

SPECIFICATION

Enters the new file specification of the .rdb file.

USER n RUJ_FILENAME

Enters the new file specification for the .ruj file for the specified user. In this syntax, *n* is a valid user number.

file-spec

Specifies the full file specification (including version number) that the .rdb file will have after it has been committed and the RdbALTER session is complete.

The file specification can be a set of double quotation marks (" ") if you are removing the .ruj file specification.

Examples

Example 1

The following example enters a new file specification for the .rdb file. You must specify a version number in the new file specification for the .rdb file. The word (*marked*) in the DEPOSIT ROOT display indicates that the .rdb file is marked for the specified location but has not been moved to that location.

```
RdbALTER> DISPLAY ROOT
Root file specification is: "DISK1:[RICK.RDB]MF_PERSONNEL.RDB;1"
RdbALTER> DEPOSIT ROOT SPECIFICATION="DISK1:[RICK]MF_PERSONNEL.RDB;1"
(marked) Root file specification is: "DISK1:[RICK]MF_PERSONNEL.RDB;1"
```

See the *Oracle Rdb Guide to Database Maintenance* for more examples of how to use the DEPOSIT ROOT command.

2.7 DETACH Command

Releases a previous database ATTACH command. The exclusive update lock is released, and other users can access the database again. Any uncommitted transactions are rolled back. No database page alterations are allowed until another ATTACH command is issued.

Format

DETACH →

Examples

Example 1

The following command detaches RdbALTER from the current database:

```
RdbALTER> DETACH
```

2.8 DISPLAY Command

2.8 DISPLAY Command

Requests display of data fields from a database page. An individual DISPLAY command can include only one of the display options shown. If no parameters are specified (you only specify DISPLAY), RdbALTER displays the last object of a PAGE, a DISPLAY, or a DEPOSIT command.

Format

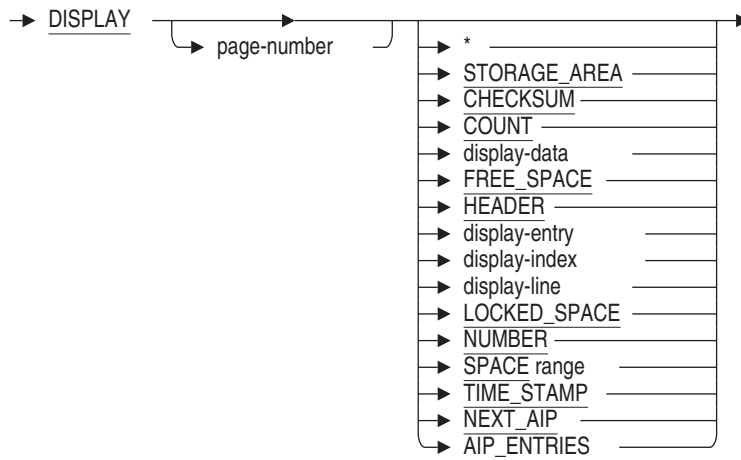

display-data =

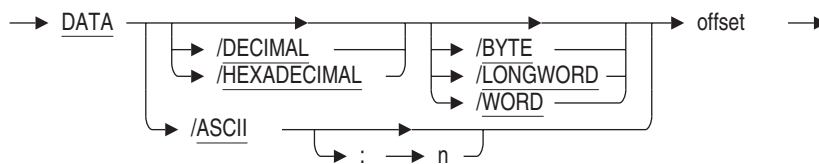

2.8 DISPLAY Command

display-entry =

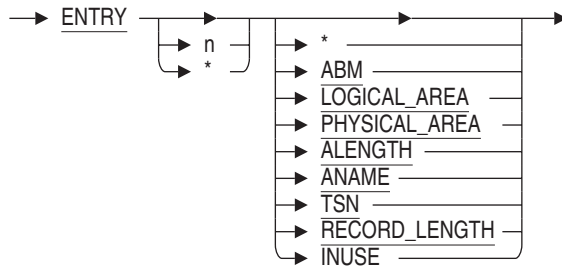

display-index =

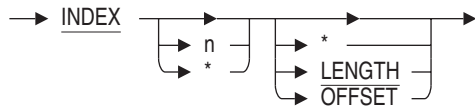

display-line =



range =

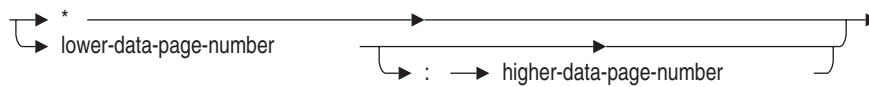

Command Parameters

page-number

Identifies the page whose information you want to display. The current page is the default.

* (asterisk)

Displays the entire page.

STORAGE_AREA

Displays the 2-byte storage area identification.

2.8 DISPLAY Command

CHECKSUM

Displays the 4-byte page checksum field.

COUNT

Displays the 2-byte field showing the number of line index entries. If this number is 1, the page contains only the SYSTEM record.

DATA offset

Displays the number of bytes specified. If you do not specify the HEXADECIMAL or DECIMAL qualifier, the default radix is assumed. See Section 2.18 for information on how to set a default radix by using the RADIX command.

The value you specify for *n* is the number of bytes you want to display. The maximum value that can be specified for *n* is the size of the page minus the offset. If you do not specify *n*, 1 byte is displayed.

The BYTE, LONGWORD, and WORD qualifiers cannot be used with the ASCII qualifier.

FREE_SPACE

Displays the 2-byte field indicating how much free space remains on the page.

HEADER

Displays the entire page header.

ENTRY (n|*)

Refers to an area inventory page (AIP) entry on the database page. If you specify a value for *n*, it must be a number between zero and the number of AIP entries. If you specify the asterisk (*) parameter, the information you request with the other DISPLAY ENTRY parameters is displayed for each AIP entry on the database page.

asterisk (*)

Displays the same information that is displayed when you specify the ABM, LOGICAL_AREA, PHYSICAL_AREA, ALENGTH, ANAME, TSN, RECORD_LENGTH, and INUSE parameters.

ABM

Displays the first area bit map (ABM) page for the specified area inventory page (AIP) entry. The value is contained in a longword.

LOGICAL_AREA

Displays the number of the logical area of an AIP entry. The value is contained in a word.

2.8 DISPLAY Command

PHYSICAL_AREA

Displays the number of the physical area of an AIP entry. The value is contained in a word.

ALENGTH

Displays the length of the name of the logical area of an AIP entry. The value is contained in 1 byte. The name of the logical area can be from 1 to 31 bytes in length.

ANAME

Displays the name of the logical area of an AIP entry. The value is contained in a 31-character text field.

TSN

Displays the value of the last transaction sequence number (TSN) to enable snapshots for the logical area of an AIP entry.

Note

Beginning in Oracle Rdb V7.0, Oracle Rdb stores any transaction sequence number that is larger than a longword by using both the TSN field on the page and the page TSN base. Oracle Rdb calculates the actual TSN by applying a formula to these two values. Oracle Corporation recommends that you do not change a TSN value that is larger than a longword. When a TSN is larger than a longword, a nonzero number is stored in the page TSN base (the page tail). The following example shows the location of the page TSN and the page TSN base:

```
000A 00000003 0000 page 3, physical area 10
      9D091204 0006 checksum = 9D091204
009A2C0F ED786D2E 000A time stamp = 23-MAY-1996 09:08:53.36
      0000 03C4 0012 964 free bytes, 0 locked
      0001 0016 1 line
      0005 03E4 0018 line 0: offset 03E4, 5 bytes
page TSN -----> 00000000 001C line 0: TSN 0
.
.
.
      2001 03E4 line 0 (10:3:0) SYSTEM record
      00 0001 03E6 1 byte in 0 sets/dynamic items
0000000000 03E9 padding '.....'
```

2.8 DISPLAY Command

```
          FFFFFFFF 03EE snap page pointer -1
          00000000 03F2 snap pointer TSN 0
             0000 03F6 MBZ '..'
          00000000 03F8 page sequence number 0
page TSN base -----> 0000 03FC page TSN base 0
             0000 03FE MBZ '..'
```

RECORD_LENGTH

Displays the value for the length of the record size for an AIP entry. The length is expressed in bytes. The RECORD_LENGTH value is contained in a word.

INUSE

Displays the AIP entry's in-use flag. The value is contained in 1 byte.

Note

In the next two parameters, the integers denoting INDEX and LINE are zero based. For example, INDEX 0 refers to the first index, and LINE 3 refers to the fourth line.

The integer *n* is optional. The present value of the relevant pointer is the default.

References to INDEX and LINE are invalid if the current page is a space area management (SPAM) page.

INDEX *n*

Displays the offset field, the length field, or both from the line index indicated by *n*. For example, if you enter DISPLAY INDEX 3 OFFSET, the offset address field from the fourth line index is displayed. If you enter DISPLAY INDEX 3 LENGTH, the length field from the fourth line index is displayed. If you enter either DISPLAY INDEX 3 or DISPLAY INDEX 3 *, both the offset and the length fields from the fourth line index are displayed.

INDEX *

Displays the offset field and the length field for all index nodes on a page.

LINE *n*

Displays information from an individual storage segment. You can display the RECORD_TYPE field or the entire content of the storage segment line indicated by *n*.

2.8 DISPLAY Command

LINE *

Displays information from all storage segments on a page.

LOCKED_SPACE

Displays the 2-byte field indicating how much free space is allocated for exclusive use by a recovery unit.

NUMBER

Shows the 4-byte page number field.

SPACE range

Displays SPAM entries; it is valid only if the current page is a SPAM page. The SPACE parameter is the only option that you can use in DISPLAY and DEPOSIT commands that access a SPAM page. The optional range value can be an asterisk (*), referring to all entries, or a set of consecutive entries that you describe as follows:

```
lower-data-page-number[:higher-data-page-number]
```

When you specify a range, you reduce the output display. The specified range of SPAM entries is included in the display; other SPAM entries outside your specified range can also be included in the display.

Each entry on a SPAM page consists of 2 bits, containing a value 0 through 3 that represents a fullness threshold. For example, if the *n*th SPAM entry contains a 2, it means that the *n*th data page in the interval has reached a percentage of fullness greater than the second threshold for the area, but less than or equal to the third threshold.

TIME_STAMP

Displays the 8-byte time stamp field.

NEXT_AIP

Displays the page number of the next area inventory page (AIP).

AIP_ENTRIES

Displays a value for the number of area inventory page (AIP) entries on the current area inventory page.

2.9 DISPLAY FILE Command

Displays the file specification in the database root (.rdb) file for a storage area (.rda) or snapshot (.snp) file. You can also use this command to display the current setting of the inconsistent flag or corrupt flag for a storage file.

If you specify the DISPLAY FILE command, but do not specify any parameters, RdbALTER will display the full file specification for the .rda or the .snp file of the storage area, the current setting of the inconsistent flag, and the current setting of the corrupt flag for .rda files.

Format

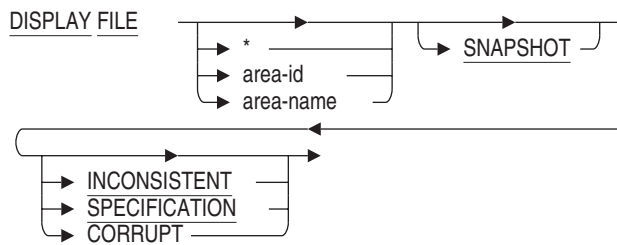

Command Parameters

*** (asterisk)**

Displays all file characteristics for all files.

area-id

Specifies the number of the storage area for which you want to display information from the .rdb file.

area-name

Specifies the name of the storage area for which you want to display information from the .rdb file.

SNAPSHOT

Displays information about an .snp file. If you select the SNAPSHOT parameter, you can specify the SPECIFICATION parameter; the INCONSISTENT and CORRUPT parameters are not valid options for .snp files.

2.9 DISPLAY FILE Command

INCONSISTENT

Displays the current setting of the inconsistent flag. This parameter applies only to .rda files.

SPECIFICATION

Displays the full file specification (including version number) for the .rda or the .snp file of the storage area.

CORRUPT

Displays the current setting of the corrupt flag. This applies only to .rda files.

Examples

Example 1

The following example displays the file specification for the JOBS storage area file:

```
RdbALTER> DISPLAY FILE JOBS
Area JOBS:
    File specification is: "DISK1:[RICK.RDB]JOBS.RDA;1"
    Corrupt flag is: OFF
    Inconsistent flag is: OFF
```

2.10 DISPLAY ROOT Command

2.10 DISPLAY ROOT Command

Displays the current database root file specification or the current recovery-unit journal (.ruj) file specification for a specific user of the database. You can use this statement to be sure you assigned the file specification you intended.

The DISPLAY ROOT SPECIFICATION command is the default if no other keyword follows the DISPLAY ROOT command.

Note

Prior to Oracle Rdb Version 6.0, you could use the DISPLAY ROOT command to display an after-image journal (.aij) file specification. This is no longer an option; use the RMU Show After_Journal command instead.

Format

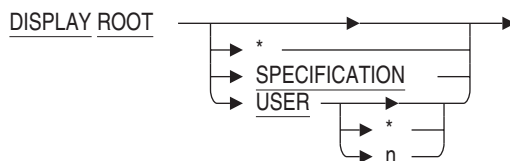

Command Parameters

* (asterisk)

Displays the current database root (.rdb) file specification.

SPECIFICATION

Displays the current .rdb file specification for the database.

USER

Displays the current recovery-unit journal (.ruj) file specification for a user of the database. The USER parameter with no qualifier results in all users being displayed; the USER parameter with the * qualifier results in all users being displayed; and the USER parameter with the *n* qualifier results in a specific user being displayed, where *n* is a valid user number.

2.10 DISPLAY ROOT Command

Examples

Example 1

The following command displays the current .rdb file specification of the database:

```
RdbALTER> DISPLAY ROOT  
Root file specification is: "DISK1:[RICK.RDB]MF_PERSONNEL.RDB;1"
```

2.11 EXIT Command

Terminates the RdbALTER session and returns you to DCL command level. You can also press Ctrl/Z to end an RdbALTER session.

If the EXIT command is issued and altered but uncommitted pages exist, you are told to issue either a COMMIT or a ROLLBACK command. RdbALTER does not exit until a COMMIT or a ROLLBACK operation has accounted for all altered pages.

The EXIT command performs an implicit NOLOG command if a log file is open.

Format

EXIT

ERROR: SDMLGEN failed to find entry for EXIT_S.RAGS

Examples

Example 1

2.11 EXIT Command

The following example exits RdbALTER command level and returns you to the DCL command level:

```
RdbALTER> EXIT
$
```

Example 2

The following example shows that you cannot exit from the RdbALTER session if there are uncommitted changes in your database:

```
RdbALTER> DEPOSIT ROOT SPECIFICATION=DISK1:[RICK]MF_PERSONNEL.RDB;1
(mark) Root file specification is: "DISK1:[RICK]MF_PERSONNEL.RDB;1"
RdbALTER> EXIT
%RMU-F-COMMITROLL, currently modified ROOT fields must be committed or
rolled back
```

2.12 HELP Command

Provides information about RdbALTER commands, terminology, and concepts. If you type HELP at the RdbALTER prompt without specifying a topic, RdbALTER displays a list of topics on which help is available. If you type HELP followed by a topic, you receive a brief description of that topic.

Format

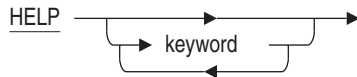

Command Parameters

keyword

Identifies the help topic or subtopic you want explained.

Examples

Example 1

The following example requests two layers of help. First, the user types HELP without specifying a topic, and a list of topics for which help is available is displayed. Then the user selects the VERIFY topic to obtain information for the VERIFY command.

```

RdbALTER> HELP

Information available:

AREA-PAGE  ATTACH    COMMIT    DEPOSIT    DETACH    DISPLAY    ERRORS
EXIT       HELP      LOG       MAKE_CONSISTENT  MOVE     NOLOG
PAGE      RADIX    ROLLBACK  UNCORRUPT  VERIFY

Topic? VERIFY
  
```

2.13 LOG Command

2.13 LOG Command

Keeps an audit trail of all or part of an RdbALTER session. After you specify the LOG command, RdbALTER commands and their results are logged in the specified log file until you close the log file by entering a NOLOG command, an EXIT command, or another LOG command.

Format

LOG file-spec →

Command Parameters

file-spec

Specifies a file to contain the audit trail log. The default file extension is .lis.

Examples

Example 1

The following command creates the file audit.lis and begins audit trail logging:

```
RdbALTER> LOG AUDIT
```

Example 2

The following command creates the file audit.trl and begins audit trail logging:

```
RdbALTER> LOG AUDIT.TRL
```

2.14 MAKE CONSISTENT Command

2.14 MAKE CONSISTENT Command

Resets an area's inconsistent indication flag, allowing you to use the database.

Description

When a storage area is restored from backup files on a by-area basis, it does not reflect data that has been updated since the backup operation. The transaction level of the restored area reflects the transaction level of the backup file, not the transaction level of the database. Therefore, the transaction level of the restored area differs from that of the database. Oracle Rdb marks the area by setting a flag in the storage area file to inconsistent.

You can perform a recovery by area to upgrade the transaction level of the restored area to that of the database. (After-image journaling must be enabled in order to restore by area.) If you are certain that no updates have been made to the database since the backup operation, you can use the MAKE CONSISTENT command in RdbALTER to change the setting of the flag from inconsistent to consistent.

Note

Beginning in Oracle Rdb Version 6.0, the capabilities provided through this command are also provided through the RMU Set Corrupt_Pages command. The RdbALTER MAKE CONSISTENT command might be removed in future versions of Oracle Rdb. Therefore, Oracle Corporation recommends that you use the RMU Set Corrupt_Pages command instead of the RdbALTER MAKE CONSISTENT command when these capabilities are needed.

Format



Command Parameters

storage-area-name

Specifies a storage area by the storage area name, which is the name defined with the SQL CREATE STORAGE AREA statement.

2.14 MAKE CONSISTENT Command

storage-area-number

Specifies a storage area by storage area number, which is assigned when the database is created and is given on the first line of a page display.

Examples

Example 1

The following example resets the indication flag from inconsistent to consistent for the area JOBS:

```
RdbALTER> MAKE CONSISTENT JOBS
          ***** WARNING! *****
          BEWARE ATTEMPTING TO MAKE CONSISTENT A STORAGE
          AREA WITHOUT FIRST VERIFYING IT USING THE
          RMU/VERIFY COMMAND.
          AN RdbALTER ROLLBACK COMMAND WILL LEAVE THIS
          AREA MARKED INCONSISTENT.
Area JOBS now marked consistent.
```

2.15 MOVE Command

Moves data (defined by beginning and ending offset addresses) from one page location to another location on the same page.

The number of bytes moved is:

$$(\text{old-offset-end}) - (\text{old-offset-start}) + 1$$

The sending field, defined by the old-offset arguments, remains unchanged.

The receiving field, defined by the new-offset argument and the length of the sending field, is replaced by the contents of the sending field.

Other information in the page is unchanged.

Format

MOVE old-offset-start:old-offset-end new-offset →

Command Parameters

old-offset-start

Specifies the hexadecimal offset address of the first byte in the data sequence to be moved.

old-offset-end

Specifies the hexadecimal offset address of the last byte in the data sequence to be moved.

new-offset

Specifies the hexadecimal offset address of the first byte in the sequence of bytes receiving the moved data.

Examples

Example 1

The following example moves data from offset location 34A through 34E to the starting offset location of 354:

```
RdbALTER> MOVE 34A:34E 354
```

See the *Oracle Rdb Guide to Database Maintenance* for more examples of how to use the MOVE command.

2.16 NOLOG Command

2.16 NOLOG Command

Stops RdbALTER logging. The NOLOG command stops audit trail logging if a previous LOG command is still in effect. The EXIT command performs an implicit NOLOG if LOG is still active; thus, you need not enter a NOLOG command before exiting the RdbALTER session.

Format

NOLOG →

Examples

Example 1

The following example stops audit trail logging:

```
RdbALTER> NOLOG
```

2.17 PAGE Command

Fetches a page from the current storage area. If you specify a valid page number, that page is fetched from the current storage area. If you enter the PAGE command without a page number, the next page in the current storage area is fetched. If you enter the PAGE command without a page number and you are already at the highest numbered page of the storage area, page 1 of the storage area is fetched.

Format

PAGE 

Command Parameters

page-number

Identifies a page to be fetched in the current storage area. If you do not specify the page-number parameter, the next page in the current area is fetched. If you do not specify a page number and you are at the highest numbered page in the storage area, page 1 of the current storage area is fetched.

Example

Example 1

The following example fetches page 14 of the current storage area:

```
RdbALTER> PAGE 14
```

Example 2

If the current page is page 15 of the JOBS storage area, the following command fetches page 16 of the JOBS storage area:

```
RdbALTER> PAGE
```

2.18 RADIX Command

2.18 RADIX Command

Sets the default radix for entering numeric data for the DISPLAY DATA command and determines how data values are parsed by the DEPOSIT DATA command.

If you do not use this command, RdbALTER expects data values to be entered as decimal values.

This command does not change the radix for specifying page offsets. Page offsets must always be specified as a hexadecimal radix number.

Format



Command Parameters

DECIMAL

Sets the default radix in decimal numbers. This is the default.

HEXADECIMAL

Sets the default radix in hexadecimal numbers.

Examples

Example 1

The following example sets the default radix for entering numeric data to hexadecimal:

```
RdbALTER> RADIX HEXADECIMAL
```

2.19 ROLLBACK Command

Ignores all page changes since the last COMMIT or last ROLLBACK command. Altered pages are stored in virtual memory until you issue a COMMIT or a ROLLBACK command. The ROLLBACK command tells RdbALTER to ignore all changes since the last COMMIT or the last ROLLBACK command was issued.

Do not follow a ROLLBACK command with a DEPOSIT command without first specifying your location again with a DISPLAY or a PAGE command.

RdbALTER does not allow you to issue an EXIT command until all altered pages are either committed or rolled back.

Format

ROLLBACK →

Examples

Example 1

The following example rolls back all page changes entered since the last COMMIT or last ROLLBACK command was issued:

```
RdbALTER> ROLLBACK
```

2.20 UNCORRUPT Command

2.20 UNCORRUPT Command

Resets the storage area's corruption indication flag (FILID_CORRUPT_FLG), allowing you to use the uncorrupted sections of a corrupted storage area. Storage areas are most often corrupted by attempting an SQL (not RdbALTER) roll back with one or more storage areas opened in batch-update transaction mode.

The UNCORRUPT command allows you to access a database that is in an uncertain condition. Accordingly, the following message is displayed when you enter the command:

```
BEWARE ATTEMPTING TO UNCORRUPT A STORAGE AREA  
WITHOUT FIRST VERIFYING IT.
```

Note

Beginning in Oracle Rdb Version 6.0, the capabilities provided through this command are also provided through the RMU Set Corrupt_Pages command. The RdbALTER UNCORRUPT command might be removed in future versions of Oracle Rdb. Therefore, Oracle Corporation recommends that you use the RMU Set Corrupt_Pages command instead of the RdbALTER UNCORRUPT command when these capabilities are needed.

Use of the ROLLBACK or the COMMIT command is permitted with the RdbALTER UNCORRUPT command.

Format

```
UNCORRUPT    → storage-area-name    →  
                  → storage-area-number
```

Command Parameters

storage-area-name

Specifies a storage area in the current database by storage area name, which is the name defined with the SQL CREATE STORAGE AREA statement.

2.20 UNCORRUPT Command

storage-area-number

Specifies an area of the current database by the storage area number, which is assigned when the database is created and is given on the first line of a page display.

Examples

Example 1

The following example resets the corruption indication flag for the EMPIDS_LOW area.

```
RdbALTER> UNCORRUPT EMPIDS_LOW
          ***** WARNING! *****
          BEWARE ATTEMPTING TO UNCORRUPT A STORAGE AREA
          WITHOUT FIRST VERIFYING IT USING THE RMU/VERIFY
          COMMAND.
          AN RdbALTER ROLLBACK COMMAND WILL LEAVE THIS
          AREA MARKED CORRUPT.
          Area EMPIDS_LOW now marked uncorrupt.
```

2.21 VERIFY Command

2.21 VERIFY Command

Verifies the current page. When the VERIFY command is issued, the page header and page checksum are verified for the current page, and error messages are issued if header or checksum corruption is found.

Format

VERIFY →

Examples

Example 1

The following example verifies area 3 page 100:

```
RdbALTER> AREA 3 PAGE 100  
RdbALTER> VERIFY
```

A

RMU Load Record Definition File Language

The record definition files (.rrd) used by the RMU Load, RMU Unload, and RMU Analyze commands are used to describe the field data types and field ordering for binary and delimited text data files. The .rrd files contain a simple language similar to that accepted by the CDO interface of the Oracle CDD Repository. The RMU Unload command automatically generates a record definition file from the table definition in the database.

This appendix describes the .rrd language which is accepted by the RMU Load command. It describes a useful subset of the language supported by RMU. Clauses from CDO which RMU accepts but ignores are not described.

A.1 DEFINE FIELD statement

Each record definition file must include at least one DEFINE FIELD statement to describe the data type of a field in the unloaded record. This statement has two formats:

- a format that defines a new name

```
define field name_string datatype is text size is 20 characters.
```
- a format that references another, previously defined, field

```
define field first_name based on name_string.
```

RMU Unload generates the DEFINE FIELD statement with just the DATATYPE clause. The full syntax is shown in Figure A-1.

The following example of the DEFINE FIELD statement is more complete, showing the use of annotations (DESCRIPTION clause) and based-on fields.

Figure A-1 DEFINE FIELD Statement

define-field =

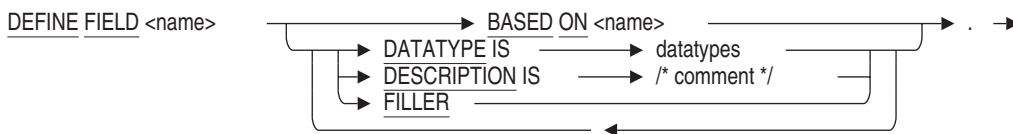

```

define field name_string
  description is
    /* This a generic string type to be used for based on */
    datatype is text size is 20 characters.
define field first_name
  based on name_string.
define field last_name
  based on name_string.

define record PERSON
  description is
    /* Record which describes the PERSON.DAT RMS file */.
    first_name.
    last_name.
end.
  
```

A.2 DEFINE RECORD Statement

The DEFINE RECORD statement defines the ordering of the fields within the file. A field may only be used once. The name of the field is not used for column name matching unless the Corresponding qualifier is used with the RMU Load command.

The ALIGNED ON clause can be used to adjust for alignment added explicitly or implicitly by host language applications. For instance, on OpenVMS Alpha many 3GL language compilers naturally align fields to take advantage of the Alpha processor hardware which executes more efficiently when data is well aligned. The default is BYTE alignment.

Figure A-2 DEFINE RECORD Statement

define-record =

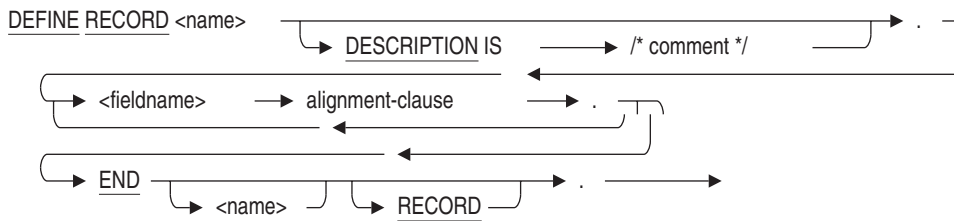

alignment-clause =

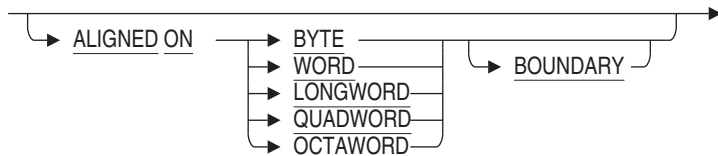

In the following example, field C is expected to start on a quadword boundary, so A is assigned the first longword, the second longword is ignored, and finally the C is assigned the last longword value.

```
define field A datatype is signed longword.
define field C datatype is signed longword.
define record RMUTEST.
    A .
    C aligned on quadword boundary.
end RMUTEST record.
```

A.2.1 Usage Notes

- When the DCL verify process is enabled using the DCL SET VERIFY command or the DCL F\$VERIFY lexical function, RMU Load writes the .rrd file being processed to SYS\$OUTPUT.
- There is no equivalent to the VARCHAR or VARYING STRING data types in the record definition language because there is no support for these types in the OpenVMS Record Management Services (RMS) environment.

- The VARCHAR or VARYING STRING data type is a two-part type with an UNSIGNED WORD (16 bit integer) length prefix with a fixed TEXT portion. The length defines the actual data in the string.

There is no equivalent to the VARCHAR or VARYING STRING data types in the record definition language as this type is not supported by the OpenVMS Record Management Services (RMS) environment.

If you unload a VARCHAR column then it will be converted to a fixed length (space padded) TEXT field. However, TEXT to VARCHAR load and unload is handled appropriately when using the delimited format. In this format RMU Unload only outputs the text as specified by the length prefix of the VARCHAR column. Likewise, RMU Load uses the length of the delimited string to set the length in the database.

- If a field is not to be used during the load into the table, it can be ignored during the load using the FILLER attribute. This allows RMU Load to use a data file which has more fields than there are columns in the database table.
- The <name> referenced in the END RECORD clause must be the same as the name defined by the DEFINE RECORD statement.
- The record definition files are not used when the Record_definition qualifier is omitted. In this case RMU Unload generates a structured internal file format which contains both the record definition and the data. This format allows the unloading of LIST OF BYTE VARYING columns and NULL values. This format is the same as that generated by SQL EXPORT for its interchange (.rbr) file. Use the RMU Dump Export command to format the contents of this file for display.

```
$ rmu/unload mf_personnel employees employees.unl
$ rmu/dump/export/nodata employees.unl
```

A.3 Additional Data Types

The data types that are supported by Oracle Rdb are described in *Oracle Rdb SQL Reference Manual*.

The cset-name is any character set supported by Oracle Rdb. These character sets are expanded from release to release. Please refer to the Oracle Rdb SQL Reference Manual for new character sets and more information on the character sets listed below.

Figure A-3 Data Types

datatypes =

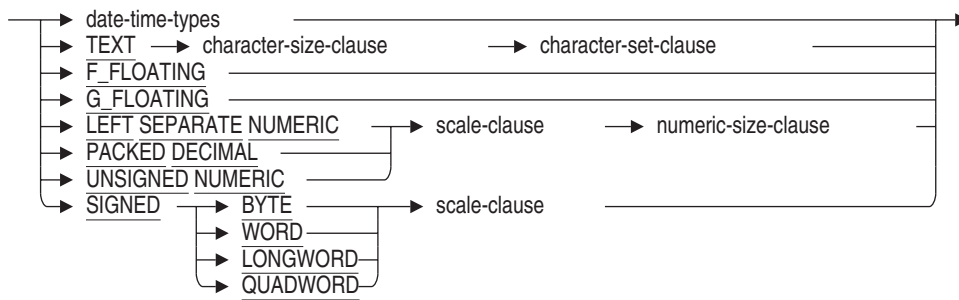

numeric-size-clause =

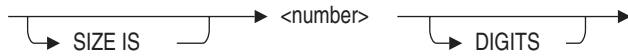

character-size-clause =

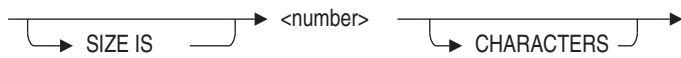

scale-clause =



character-set-clause =

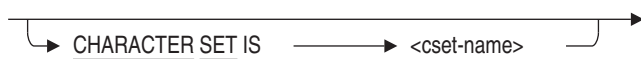

When several character sets are available for the same language (such as Kanji and Hanyu), each is based on a different local or international standard that differs from the others in format and structure. For instance, SHIFT_JIS is

widely used with Microsoft Windows systems in Japan, but differs in format from the DEC_KANJI character set supported by Hewlett Packard Company's DECWindows product.

Table A–1 Character sets supported by Oracle RMU Load

Character Set	Description
ARABIC	Arabic characters as defined by the ASMO 449 and ISO9036 standards
BIG5	A set of characters used by the Taiwan information industry
DEC_HANYU	Traditional Chinese characters (Hanyu) as used in Taiwan and defined by standard CNS11643:1986, supplemental characters as defined by DTSCC and ASCII
DEC_HANZI	Chinese (Bopomofo) characters as defined by standard GB2312:1980 and ASCII characters
DEC_KANJI	Japanese characters as defined by the JIS X0208:1990 standard, Hankaku Katakana characters as defined by JIS X0201:1976 prefixed by SS2 (8E hex), user-defined characters, and ASCII characters
DEC_KOREAN	Korean characters as defined by standard KS C5601:1987 and ASCII characters
DEC_MCS	A set of international alphanumeric characters, including characters with diacritical marks
DEC_SICGCC	Traditional Chinese characters (Hanyu) as used in Taiwan and defined by standard CNS11643:1986 and ASCII
DEVANAGARI	Devanagari characters as defined by the ISCII:1988 standard
DOS_LATIN1	DOS Latin 1 code
DOS_LATINUS	DOS Latin US code
HANYU	Traditional Chinese characters (Hanyu) as used in Taiwan and defined by the standard CNS11643:1986
HANZI	Chinese (Bopomofo) characters as defined by standard GB2312:1980
HEX	Translation of text data to and from hexadecimal data
ISOLATINARABIC	Arabic characters as defined by the ISO/IEC 8859-6:1987 standard
ISOLATINCYRILLIC	Cyrillic characters as defined by the ISO/IEC 8859-5:1987 standard
ISOLATINGREEK	Greek characters as defined by the ISO/IEC 8859-7:1987 standard
ISOLATINHEBREW	Hebrew characters as defined by the ISO/IEC 8859-8:1987 standard
KANJI	Japanese characters as defined by the JIS X0208:1990 standard and user-defined characters

(continued on next page)

Table A–1 (Cont.) Character sets supported by Oracle RMU Load

Character Set	Description
KATAKANA	Japanese phonetic alphabet (Hankaku Katakana), as defined by standard JIS X0201:1976
KOREAN	Korean characters as defined by standard KS C5601:1987
SHIFT_JIS	Japanese characters as defined by the JIS X0208:1990 standard using Shift_JIS specific encoding scheme, Hankaku Katakana characters as defined by JIS X0201:1976, and ASCII characters
TACTIS	Thai characters based on TACTIS (Thai API Consortium/Thai Industrial Standard) which is a combination of ISO 646-1983 and TIS 620-2533 standards
UNICODE	Unicode characters as described by Unicode Standard and ISO/IEC 10646 transformation format UTF-16
UTF8	Unicode characters as described by Unicode Standard and ISO/IEC 10646 UTF-encoding form
WIN_ARABIC	MS Windows Code Page 1256 8-Bit Latin/Arabic
WIN_CYRILLIC	MS Windows Code Page 1251 8-Bit Latin/Cyrillic
WIN_GREEK	MS Windows Code Page 1253 8-Bit Latin/Greek
WIN_HEBREW	MS Windows Code Page 1255 8-Bit Latin/Hebrew
WIN_LATIN1	MS Windows Code Page 1252 8-Bit West European

A.3.1 Date-Time Syntax

The date-time syntax in .rrd files generated by the RMU Unload command with the Record_Definition=(File=file) command is compatible with the date-time syntax support of Oracle CDD/Repository V6.1 and later versions.

The date-time data type has the following syntax in the .rrd file.

date-time-types =

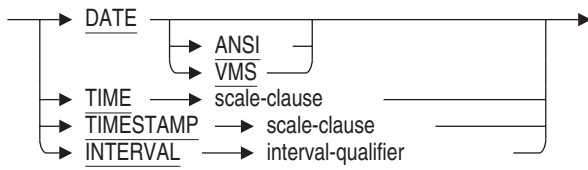

interval-qualifier =

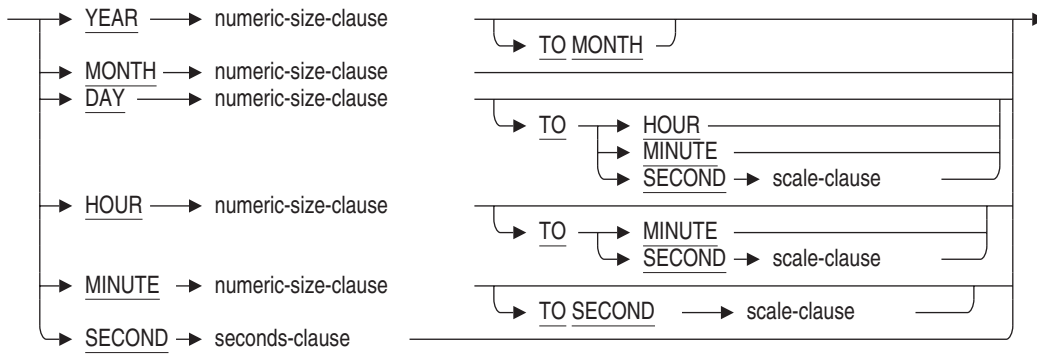

scale-clause =

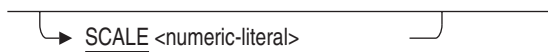

numeric-size-clause =

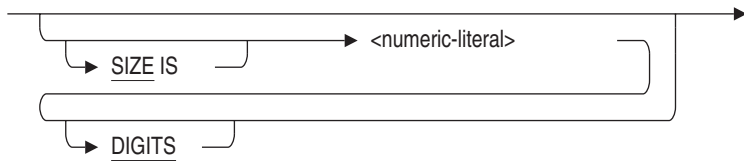

seconds-clause =

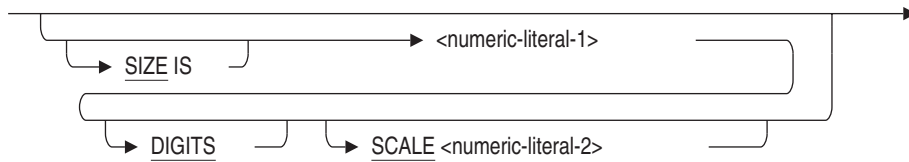

Note that SCALE values must be between 0 and -2 and that SIZE IS values must be between 2 and 9.

The following are examples of typical field definitions for date-time data types in .rrd files:

```
DEFINE FIELD A DATATYPE IS DATE.  
DEFINE FIELD B DATATYPE IS DATE ANSI.  
DEFINE FIELD C DATATYPE IS INTERVAL DAY SIZE IS 2 DIGITS.  
DEFINE FIELD D DATATYPE IS INTERVAL DAY SIZE IS 2 DIGITS TO HOUR.  
DEFINE FIELD E DATATYPE IS INTERVAL DAY SIZE IS 2 DIGITS TO  
SECOND SCALE -2.  
DEFINE FIELD F DATATYPE IS INTERVAL HOUR SIZE IS 4 DIGITS.  
DEFINE FIELD G DATATYPE IS INTERVAL HOUR SIZE IS 2 DIGITS TO MINUTE.  
DEFINE FIELD H DATATYPE IS INTERVAL MINUTE SIZE IS 2 DIGITS TO  
SECOND SCALE -2.  
DEFINE FIELD I DATATYPE IS INTERVAL SECOND SIZE IS 2 DIGITS SCALE -2.  
DEFINE FIELD J DATATYPE IS TIME.  
DEFINE FIELD K DATATYPE IS TIME SCALE -1.  
DEFINE FIELD L DATATYPE IS TIMESTAMP SCALE -2.  
DEFINE FIELD M DATATYPE IS INTERVAL YEAR SIZE IS 3 DIGITS TO MONTH.
```

B

Using LogMiner for Rdb

This appendix provides information about using the LogMiner for Rdb feature.

Oracle Rdb after-image journal (.aij) files contain a wealth of useful information about the history of transactions in a database. After-image journal files contain all of the data needed to perform database recovery. These files record every change made to data and metadata in the database. The LogMiner for Rdb feature provides an interface to the data record contents of Oracle Rdb after-image journal files. Data records that are added, updated, or deleted by committed transactions may be extracted (unloaded) from the .aij files in a format suitable for subsequent loading into another database or for use by user-written application programs.

Oracle Rdb after-image journaling protects the integrity of your data by recording all changes made by committed transactions to a database in a sequential log or journal file. Oracle Corporation recommends that you enable after-image journaling to record your database transaction activity between full backup operations as part of your database restore and recovery strategy. The after-image journal file is also used to enable several database performance enhancements (such as the fast commit, row cache, and hot standby features).

See the *Oracle Rdb7 Guide to Database Maintenance* for more information about setting up after-image journaling.

To use LogMiner for Rdb, follow these steps:

1. Enable the database for LogMiner operation using the RMU Set Logminer command. See Section 1.56 for additional information.
2. Back up the after-image journal file using the Quiet_Point qualifier to the RMU Backup command.
3. Extract changed records using the RMU Unload After_Journal command. See the Unload After_Journal help topic for additional information.

B.1 Restrictions and Limitations with LogMiner for Rdb

The following restrictions exist for the LogMiner for Rdb feature:

- Temporary tables cannot be extracted. Modifications to temporary tables are not written to the after-image journal file and, therefore, are not available to LogMiner for Rdb.
- Optimized after-image journal files cannot be used as input to the LogMiner for Rdb. Information needed by the RMU Unload After_Journal command is removed by the optimization process.
- Records removed from tables using the SQL TRUNCATE TABLE statement are not extracted. The SQL TRUNCATE TABLE statement does not journal each individual data record being removed from the database.
- Records removed by dropping tables using the SQL DROP TABLE statement are not extracted. The SQL DROP TABLE statement does not journal each individual data record being removed from the database.
- Tables that use the vertical record partitioning (VRP) feature cannot be extracted using LogMiner for Rdb. LogMiner software currently does not detect these tables. A future release of Oracle Rdb will detect and reject access to vertically partitioned tables.
- Segmented string data (BLOB) cannot be extracted using LogMiner for Rdb. Because the segmented string data is related to the base table row by means of a database key, there is no convenient way to determine what data to extract. Additionally, the data type of an extracted column is changed from LIST OF BYTE VARYING to BIGINT. This column contains the DBKEY of the original BLOB data. Therefore, the contents of this column should be considered unreliable.
- COMPUTED BY columns in a table are not extracted. These columns are not stored in the after-image journal file.
- VARCHAR fields are not space padded in the output file. The VARCHAR data type is extracted as a 2-byte count field and a fixed-length data field. The 2-byte count field indicates the number of valid characters in the fixed-length data field. Any additional contents in the data field are unpredictable.
- You cannot extract changes to a table when the table definition is changed within an after-image journal file. Data definition language (DDL) changes to a table are not allowed within an .ajj file being extracted. All records in an .ajj file must be the current record version. If you are going to perform

DDL operations on tables that you wish to extract using the LogMiner for Rdb, you should:

1. Back up your after-image journal files.
 2. Extract the .aij files using the RMU Unload After_Journal command.
 3. Make the DDL changes.
- Do not use the OpenVMS Alpha High Performance Sort/Merge utility (selected by defining the logical name SORTSHR to SYS\$SHARE:HYPERSORT) when using LogMiner for Rdb. HYPERSORT supports only a subset of the library sort routines that LogMiner requires. Make sure that the SORTSHR logical name is not defined to HYPERSORT.

B.2 Information Returned by LogMiner for Rdb

LogMiner for Rdb appends several output fields to the data fields, creating an output record. The output record contains fixed-length fields in a binary data format (that is, integer fields are not converted to text strings). The data fields correspond to the extracted table columns. This information may or may not be required by all applications and readers of the data. There is currently no available method to restrict or reorder the output fields.

Extracted data field contents are the fields that are actually stored in the Oracle Rdb database. COMPUTED BY fields are not extracted because they are not stored in the database or in the after-image journal file. Segmented string (BLOB) contents are not extracted.

Table B–1 describes the output fields and data types of an output record.

Table B-1 Output Fields

Field Name	Data Type	Byte Length	Description
ACTION	CHAR (1)	1	Indicates record state. "M" indicates an insert or modify action. "D" indicates a delete action. "E" indicates stream end-of-file (EOF) when a callback routine is being used. "P" indicates a value from the command line Parameter qualifier when a callback routine is being used (see Parameter qualifier). "C" indicates transaction commit information when the Include=Action=Commit qualifier is specified.
RELATION_NAME	CHAR (31)	31	Table name. Space padded to 31 characters.
RECORD_TYPE	INTEGER (Longword)	4	The Oracle Rdb internal relation identifier.
DATA_LEN	SMALLINT (Word)	2	Length, in bytes, of the data record content.
NBV_LEN	SMALLINT (Word)	2	Length, in bits, of the null bit vector content.
DBK	BIGINT (Quadword)	8	Records logical database key. The database key is a 3-field structure containing a 16-bit line number, a 32-bit page number and a 16-bit area number.
START_TAD	DATE VMS (Quadword)	8	Date/time of the start of the transaction.
COMMIT_TAD	DATE VMS (Quadword)	8	Date/time of the commitment of the transaction.
TSN	BIGINT (Quadword)	8	Transaction sequence number of the transaction that performed the record operation.
RECORD_VERSION	SMALLINT (Word)	2	Record version.
Record Data	Varies		Actual data record field contents.

(continued on next page)

Table B–1 (Cont.) Output Fields

Field Name	Data Type	Byte Length	Description
Record NBV	BIT VECTOR (array of bits)		Null bit vector. There is one bit for each field in the data record. If a bit value is 1, the corresponding field is NULL; if a bit value is 0, the corresponding field is not NULL and contains an actual data value. The null bit vector begins on a byte boundary. Any extra bits in the final byte of the vector after the final null bit are unused.

B.3 Record Definition Prefix for LogMiner Fields

An RMS file containing the record structure definition for the output file can be used as an input file to the RMU Load command if extracted data is to be loaded into an Oracle Rdb database. The record description uses the CDO record and field definition format (this is the format used by the RMU Load and RMU Unload commands when the Record_Definition qualifier is used). The default file extension is .rrd.

The record definition for the fields that LogMiner for Rdb writes to the output is shown in the following example. These fields can be manually appended to a record definition file for the actual user data fields being unloaded. Alternately, the Record_Definition qualifier can be used with the Table qualifier or within an Options file to automatically create the record definition file. This can be used to load a transaction table within a database. A **transaction table** is the output that LogMiner for Rdb writes to a table consisting of sequential transactions performed in a database.

```

DEFINE FIELD RDB$LM_ACTION          DATATYPE IS TEXT SIZE IS 1.
DEFINE FIELD RDB$LM_RELATION_NAME   DATATYPE IS TEXT SIZE IS 31.
DEFINE FIELD RDB$LM_RECORD_TYPE     DATATYPE IS SIGNED LONGWORD.
DEFINE FIELD RDB$LM_DATA_LEN        DATATYPE IS SIGNED WORD.
DEFINE FIELD RDB$LM_NBV_LEN         DATATYPE IS SIGNED WORD.
DEFINE FIELD RDB$LM_DBK              DATATYPE IS SIGNED QUADWORD.
DEFINE FIELD RDB$LM_START_TAD       DATATYPE IS DATE
DEFINE FIELD RDB$LM_COMMIT_TAD      DATATYPE IS DATE
DEFINE FIELD RDB$LM_TSN              DATATYPE IS SIGNED QUADWORD.
DEFINE FIELD RDB$LM_RECORD_VERSION  DATATYPE IS SIGNED WORD.

```

B.4 SQL Table Definition Prefix for LogMiner Fields

The SQL record definition for the fields that LogMiner for Rdb writes to the output is shown in the following example. These fields can be manually appended to the table creation command for the actual user data fields being unloaded. Alternately, the Table_Definition qualifier can be used with the Table qualifier or within an Options file to automatically create the SQL definition file. This can be used to create a transaction table of changed data.

```
SQL> create table MYLOGTABLE (  
cont> RDB$LM_ACTION          CHAR,  
cont> RDB$LM_RELATION_NAME    CHAR (31),  
cont> RDB$LM_RECORD_TYPE      INTEGER,  
cont> RDB$LM_DATA_LEN         SMALLINT,  
cont> RDB$LM_NBV_LEN          SMALLINT,  
cont> RDB$LM_DBK              BIGINT,  
cont> RDB$LM_START_TAD        DATE VMS,  
cont> RDB$LM_COMMIT_TAD       DATE VMS,  
cont> RDB$LM_TSN              BIGINT,  
cont> RDB$LM_RECORD_VERSION   SMALLINT ...);
```

B.5 Segmented String Columns

Segmented string (also called BLOB or LIST OF BYTE VARYING) column data is not extracted. However, the field definition itself is extracted as a quadword integer representing the database key of the original segmented string data. In generated table definition or record definition files, a comment is added indicating that the segmented string data type is not supported by LogMiner for Rdb.

B.6 Using LogMiner to Minimize Application Downtime for Maintenance

Lengthy offline application or database maintenance operations can pose a significant problem in high-availability production environments. The LogMiner for Rdb feature can help reduce the length of downtime to a matter of minutes.

If a back up of the database is used for maintenance operations, the application can continue to be modified during lengthy maintenance operations. Once the maintenance is complete, the application can be shut down, the production system .ajj file or files can be backed up, and LogMiner for Rdb can be used to extract changes made to production tables since the database was backed up. These changes can then be applied (using an application program or the trigger technique previously described) to the new database. Once the new database has been updated, the application can be restarted using the new database.

The sequence of events required would be similar to the following:

1. Perform a full online, quiet-point database backup of the production database.
2. Restore the backup to create a new database that will eventually become the production database.
3. Perform maintenance operations on the new database. (Note that the production system continues to run.)
4. Perform an online, quiet-point after-image journal backup of the production database.
5. Use the RMU Unload After_Journal command to unload all database tables into individual output files from the .aij backup file.
6. Using either the trigger technique or an application program, update the tables in the new database with the changed data.
7. Shut down the production application and close the database.
8. Perform an offline, quiet-point after-image journal backup of the production database.
9. Use the RMU Unload After_Journal command to unload all database tables into individual output files from the .aij backup file.
10. Using either the trigger technique or an application program, update the tables in the new database with the changed data.
11. Start an online, quiet-point backup of the new database.
12. Change logical names or the environment to specify the new database root file as the production database.
13. Restart the application on the new database.

Depending on the amount of application database activity, steps 4, 5, and 6 can be repeated to limit the amount of data that needs to be applied (and the amount of downtime required) during the final after-image journal backup and apply stage in steps 8, 9, and 10.

B.7 Using an OpenVMS Pipe

You can use an OpenVMS pipe to pass data from the RMU Unload After_Journal command to another application (for example, RMU Load). Do not use any options (such as the Log or Verify qualifiers) that could cause LogMiner to send extra output to the SYS\$OUTPUT device, as that information would be part of the input data source stream to the next pipeline segment.

You may find that the OpenVMS default size of the pipe is too small if the records being extracted (including LogMiner fields) are larger than 256 bytes. If the pipe is too small, increase the SYSGEN parameters MAXBUF and DEFMBXMXMSG, and then reboot the system.

The following example uses LogMiner for Rdb to direct output to an OpenVMS pipe device and uses RMU Load to read the pipe device as the input data record stream. Using the pipeline allows parallel processing and also avoids the need for an intermediate disk file. Note that you must have created the record definition (.rrd) file prior to executing the command.

```
$ PIPE (RMU /UNLOAD /AFTER_JOURNAL OLTP.RDB AIJ1.AIJ -  
  /TABLE = (NAME = MYTBL, OUTPUT = SYS$OUTPUT:)) -  
  | (RMU /LOAD REPORTS.RDB MYLOGTBL SYS$PIPE: -  
  /RECORD_DEFINITION = FILE = MYLOGTBL.RRD)
```

A

- ABM pages
 - repairing, 1-416
 - verifying, 1-738
- Access Control Entry
 - See ACE
- Access control list
 - See ACL
- Access privilege set
 - See APS
- ACE
 - for root file, 1-569
- ACL
 - auditing changes to, 1-543
 - delete protections, 1-237
 - extracting, 1-237
 - modifying the root file, 1-569
- Activating the Oracle Rdb monitor process,
1-339
- Adding .aij files, 1-520
- Adding AIJ cache, 1-520
- After-image journal (.aij) file, 1-95
 - See also Journaling, After-image journaling
 - adding
 - using RMU Copy_Database command,
1-167
 - using RMU Move_Area command, 1-348
 - using RMU Restore command, 1-439
 - using RMU Restore Only_Root command,
1-482
 - using RMU Set After_Journal command,
1-520
 - After-image journal (.aij) file (cont'd)
 - automatic recovery of, 1-430
 - backing up, 1-96
 - backing up to tape, 1-98, 1-103
 - See also Tapes
 - backup file, 1-96
 - copying, 1-95
 - creating
 - using RMU Copy_Database command,
1-167
 - using RMU Move_Area command, 1-348
 - using RMU Restore command, 1-439
 - using RMU Restore Only_Root command,
1-482
 - using RMU Set After_Journal command,
1-521
 - database convert operation and, 1-155
 - displaying output, 1-199
 - displaying unresolved transactions, 1-208
 - dropping
 - using RMU Set After_Journal command,
1-520
 - extracting record contents, 1-702
 - initialization of I/O buffers, 1-122
 - RDM\$BIND_AIJ_INITIALIZE_IO_
COUNT logical name, 1-122
 - RDM\$BIND_AIJ_INITIALIZE_IO_SIZE
logical name, 1-122
 - managing, 1-95
 - modifying
 - using RMU Set After_Journal command,
1-520
 - optimizing, 1-369
 - overwriting, 1-520
 - protection on backup file, 1-113

After-image journal (.aij) file (cont'd)

- reserving
 - using RMU Convert command, 1-159
 - using RMU Copy_Database command, 1-167
 - using RMU Move_Area command, 1-348
 - using RMU Restore command, 1-439
 - using RMU Restore Only_Root command, 1-482
 - using RMU Set After_Journal command, 1-520
- suppressing use of, 1-520
- unloading
 - using RMU Unload After_Journal command, 1-702
 - using to recover a database, 1-391, 1-430

After-image journal (AIJ) log server

See ALS

After-image journaling

- disabling, 1-520
- enabling, 1-520
- resuming backup of, 1-513
- suspending backup of, 1-515

AIJ Backup Server, 1-515

AIJ cache

- adding, 1-528
- disabling, 1-528
- enabling, 1-528

AIJ object definition

- extracting, 1-234

AIJ temporary work file

- RDM\$BIND_AIJ_WORK_FILE logical name, 1-383, 1-402
- RDM\$BIND_DBR_WORK_FILE logical name, 1-383, 1-402

AIP

- count in a storage area, 1-19
- verifying, 1-738

AIP entries

- correcting, 1-422

Alarms

- security, 1-539

Allocating storage

- improving performance, 1-422

Allocating tape drive

- for .aij backup file, 1-121
- for database backup file, 1-78

ALS

- reopening the output file, 1-507
- starting, 1-509
- stopping, 1-511

Alter command, 1-11

- See also* RdbAlter
- correcting AIP entries, 1-422

Analyze Cardinality command, 1-22

- Confirm qualifier, 1-24
- description, 1-22
- examples, 1-27
- Output qualifier, 1-25
- storing cardinality of tables and indexes, 1-22
- Transaction_Type qualifier, 1-25
- Update qualifier, 1-26

Analyze command, 1-13

- Areas qualifier, 1-13
- Binary_Output qualifier, 1-14
- description, 1-13
- End qualifier, 1-15
- examples, 1-20
- Exclude=options qualifier, 1-15
- gathering statistics, 1-13
- Lareas qualifier, 1-16
- Option qualifier, 1-16
- Output qualifier, 1-16
- Start qualifier, 1-16
- syntax for .rrd file, A-7

Analyze Indexes command, 1-28

- Binary_Output qualifier, 1-31
- description, 1-28
- examples, 1-37
- Exclude=Metadata qualifier, 1-32
- gathering statistics, 1-28
- Option qualifier, 1-32
- Output qualifier, 1-32
- Transaction_Type qualifier, 1-33

Analyze Placement command, 1-39

- Areas qualifier, 1-40
- Binary_Output qualifier, 1-41
- description, 1-39

- Analyze Placement command (cont'd)
 - examples, 1-46
 - Exclude=Metadata qualifier, 1-42
 - gathering statistics, 1-39
 - Option qualifier, 1-42
 - Output qualifier, 1-42
 - Transaction_Type qualifier, 1-42
- Analyzing cardinality of disabled indexes, 1-24
- Analyzing compressed index keys, 1-32
- Analyzing databases, 1-13, 1-39
- Analyzing disabled index structures, 1-30
- Analyzing placement of an index, 1-40
- Analyzing placement of disabled indexes, 1-40
- Analyzing record placement relative to indexes, 1-39
- APS
 - auditing changes to, 1-543
- Area bit map pages
 - See* ABM pages
- Area inventory page
 - See* AIP
- AREA . . . PAGE command (RdbALTER), 2-4
- Area qualifiers
 - See* Parameter qualifiers
- ATTACH command (RdbALTER), 2-6
 - releasing, 2-19
- Attaching RdbALTER to a database, 2-6
- Audit event
 - disabling DACCESS, 1-540
 - enabling DACCESS, 1-540
- Audit event classes, 1-540
- Auditing
 - ACL changes, 1-543
 - APS changes, 1-543
 - characteristics, 1-604
 - disabling, 1-539
 - enabling, 1-539, 1-540
 - specific objects, 1-541
 - specific object types, 1-541
 - starting, 1-544
 - stopping, 1-545
 - use of Oracle RMU commands, 1-543

- Audit journal, 1-539
- Audit journal records
 - creating a database for storing, 1-304
 - defining a table for storing, 1-304, 1-305
- Automatic .ajj file recovery during a restore operation, 1-430, 1-461

B

- Backing up a database, 1-47, 1-127
 - to tape
 - See also* Tape, 1-48
- Backing up a database by area
 - See* Backup command
- Backing up an .ajj file, 1-96
 - to tape, 1-96
 - improving performance of, 1-101
- Backup After_Journal command, 1-95
 - Accept_Label qualifier, 1-100
 - Active_IO qualifier, 1-101
 - Block_Size qualifier, 1-101
 - Continuous qualifier, 1-101
 - Crc=Autodin_II qualifier, 1-102
 - Crc=Checksum qualifier, 1-102
 - Density qualifier, 1-103
 - Edit_Filename qualifier, 1-105
 - Encrypt qualifier, 1-106
 - examples, 1-123
 - Format qualifier, 1-106
 - Group_Size qualifier, 1-107
 - Interval qualifier, 1-108
 - Label qualifier, 1-108
 - Librarian qualifier, 1-109
 - Lock_Timeout=seconds qualifier, 1-111
 - Log qualifier, 1-111
 - Media Loader qualifier, 1-111
 - Nocrc qualifier, 1-103
 - Owner qualifier, 1-112
 - Prompt qualifier, 1-112
 - Protection=file-protection qualifier, 1-113
 - Quiet_Point qualifier, 1-113
 - Rename qualifier, 1-114
 - Rewind qualifier, 1-115
 - Sequence=(n,m) qualifier, 1-115
 - Tape_Expiration=date-time qualifier, 1-116

Backup After_Journal command (cont'd)

Threshold qualifier, 1-117

Until qualifier, 1-117

Wait qualifier, 1-117

Backup command, 1-47

Accept_Label qualifier, 1-53

Acl qualifier, 1-53

Active_IO qualifier, 1-54

Allocation qualifier, 1-54

backing up a database, 1-47

backing up a database by area, 1-58

Block_Size qualifier, 1-54

by area, 1-59

Checksum_Verification qualifier, 1-54

Compression qualifier, 1-55

Crc=Autodin_II qualifier, 1-55

Crc=Checksum qualifier, 1-55

Density qualifier, 1-56

Disk_File qualifier, 1-57

Encrypt qualifier, 1-58

examples, 1-87

Exclude qualifier, 1-58

Execute qualifier, 1-60

Extend_Quantity qualifier, 1-60

format, 1-47

Group_Size qualifier, 1-61

Include qualifier, 1-61

Incremental qualifier, 1-62

Journal qualifier, 1-63

Label qualifier, 1-64

Librarian qualifier, 1-65

List_Plan qualifier, 1-67

Loader_Synchronization qualifier, 1-68

Lock_Timeout=seconds qualifier, 1-69

Log qualifier, 1-69

Master qualifier, 1-69, 1-70

Media_Loader qualifier, 1-70

Nocrc qualifier, 1-55

No_Read_Only qualifier, 1-70

Online qualifier, 1-71

options file, 1-75

Owner qualifier, 1-72

Owner_Uic qualifier, 1-72

Page_Buffers qualifier, 1-72

Parallel qualifier, 1-72

Backup command (cont'd)

plan file, 1-49, 1-67, 1-127

Prompt qualifier, 1-74

Protection=file-protection qualifier, 1-74

Quiet_Point qualifier, 1-75

Reader_Thread_Ratio qualifier, 1-75

Restore_Options qualifier, 1-75

Rewind qualifier, 1-76

Scan_Optimization qualifier, 1-76

Tape_Expiration=date-time qualifier, 1-77

truncating file names, 1-82

Backup file

.ajj file, 1-95

 protection on, 1-113

database

 protection on, 1-74

displaying output, 1-213

size of, 1-81

truncation of name, 1-82

Backup operation

after-image journal (.ajj) file, 1-95

by area, 1-58, 1-59

database, 1-47, 1-430

multithreaded, 1-48

online, 1-71

parallel, 1-48

to tape

See Tape

Backup performance

job priority and, 1-82

Backup Plan command, 1-127

examples, 1-128

Execute qualifier, 1-127

List_Plan qualifier, 1-127

Buffers

communications, 1-280, 1-294

database, 1-287, 1-294

global, 1-170, 1-443

local, 1-170, 1-448

monitor buffers available, 1-667, 1-669

page, 1-72, 1-172, 1-352, 1-451

Buffer_Object features

disabling, 1-554

enabling, 1-554

By-area backup operation, 1-59
By-area restore operation, 1-436, 1-440

C

Cardinality of tables and indexes

RMU Analyze Cardinality command, 1-22

Cardinality statistics

collecting, 1-140

Case sensitivity, 1-307

command qualifiers, 1-2

RMU Extract command and, 1-232

RMU Unload command and, 1-689

Characteristics

security auditing, 1-604

Character set

with RMU Extract command, 1-232

with RMU Load command, 1-307

with RMU Unload command, 1-689

Character sets, A-6

Checking internal structures, 1-738

Checkpoint command, 1-131

Wait qualifier, 1-132

Checkpoint operation, 1-131

Classes of audit events, 1-540

Close command, 1-134

Abort qualifier, 1-135

Delprc option, 1-135

Forcex option, 1-135

Cluster qualifier, 1-136

eliminating active users, 1-134, 1-138

examples, 1-139

Path qualifier, 1-137

Wait qualifier, 1-138

Closing a database, 1-134

Closing a monitor log file, 1-337

Collating sequence

extracting from database, 1-234

Collecting cardinality statistics, 1-140

Collecting optimizer statistics, 1-140

Collecting storage statistics, 1-140

Collecting workload statistics, 1-140

Collect Optimizer_Statistics command, 1-140

examples, 1-150

Exclude_Tables qualifier, 1-143

Collect Optimizer_Statistics command (cont'd)

Indexes qualifier, 1-144

Log qualifier, 1-144

Row_Count qualifier, 1-144

Statistics qualifier, 1-144

System_Relations qualifier, 1-145

Tables qualifier, 1-146

Transaction_Type qualifier, 1-146

Command parameters, 1-1

Command qualifiers, 1-2

case sensitivity of, 1-2

Commands

auditing the use of, 1-543

Command syntax, xii, 1-10

COMMIT command (RdbALTER), 2-8

Committing changes

with RdbALTER, 2-8

Communications buffers, 1-280, 1-294

Compatibility

of lock modes, 1-620t

Compressed index keys

analyzing, 1-32

Compression ratio

of index keys, 1-30

Constraint

extracting from database, 1-235

Constraint evaluation

RMU Load command and, 1-288

Constraint violations

RMU Load command and, 1-297

Continuous LogMiner

Using the Unload After_Journal command,
1-705

Conventions

for command format, xii

used in manual, xv

Conversion of data types

by RMU Load command, 1-285t

Conversion of multifile databases, 1-156

Convert command, 1-155

after-image journaling and, 1-155

called by RMU Restore command, 1-430

Commit qualifier, 1-158

committing a database conversion, 1-158

Confirm qualifier, 1-158

Convert command (cont'd)

- enabling user input during conversion, 1-158
- function, 1-155
- multisegment index cardinality update, 1-160
- Path qualifier, 1-158
- Prefix_Collection qualifier, 1-158
- Reserve qualifier, 1-159
- reserving .aj files, 1-159
- reserving storage areas, 1-159
- Rollback qualifier, 1-159
- rolling back a converted database, 1-159
- specifying a path name
 - Path qualifier, 1-158
- versions of Oracle Rdb supported, 1-155

Converting a database

- RMU Convert command, 1-155
- RMU Restore command, 1-430

Copying a database

See Copy_Database command

Copying an .aj file, 1-95

Copy_Database command, 1-165

- After_Journal qualifier, 1-166
- Aij_Options qualifier, 1-167
- Blocks_Per_Page qualifier, 1-175
- Cdd_Integrate qualifier, 1-168
- Checksum_Verification qualifier, 1-168
- Directory qualifier, 1-169
- Duplicate qualifier, 1-169
- examples, 1-179
- Extension qualifier, 1-175
- File qualifier, 1-176
- Global_Buffers qualifier, 1-170
- Local_Buffers qualifier, 1-170
- Lock_Timeout=n qualifier, 1-171
- Log qualifier, 1-171
- Nodes_Max qualifier, 1-171
- Online qualifier, 1-171
- Open_Mode qualifier, 1-172
- Option qualifier, 1-172
- Page_Buffers qualifier, 1-172
- Path qualifier, 1-172
- Quiet_Point qualifier, 1-173
- Read_Only qualifier, 1-176
- Read_Write qualifier, 1-176
- Root qualifier, 1-173

Copy_Database command (cont'd)

- Snapshots qualifier, 1-176
- Spams qualifier, 1-177
- Thresholds qualifier, 1-177
- Transaction_Mode qualifier, 1-174
- Users_Max qualifier, 1-175
- Correcting ABM errors, 1-415
- Correcting AIP entries
 - with RMU Repair command, 1-422
- Correcting list area problems, 1-415
- Correcting page tail errors, 1-415
- Correcting performance problems, 1-415
- Correcting segmented string area problems, 1-415
- Correcting SPAM problems, 1-415
- Corrupted database
 - recovery of, 1-411
- Corrupt pages
 - setting to consistent, 1-557
- Creating a backup .aj file, 1-95
- Creating a backup copy of database, 1-47
- Creating a duplicate database
 - with RMU Copy_Database command, 1-165
- CSN values, 1-483, 1-488
 - initializing, 1-483
 - setting, 1-478, 1-482, 1-483, 1-488, 1-495

D

DACCESS audit events

- enabling or disabling, 1-540
 - for specific objects, 1-541
- privileges for database objects, 1-542

Database

- analyzing, 1-13
- changing
 - after-image journal (.aj) file specification, 1-520
 - recovery-unit journal (.ruj) file specification, 2-17
 - root file specification, 2-17
- closing, 1-134
- creating a duplicate of, 1-165
- displaying .aj file configuration, 1-594
- displaying contents of database, 1-188
- displaying corrupt page table entries, 1-609

- Database (cont'd)
 - displaying fields, 2-20
 - displaying security auditing characteristics, 1-604
 - extracting attributes and characteristics, 1-235
 - for storing security audit journal records, 1-304
 - moving, 2-1
 - data, 2-37
 - online backup operation, 1-47
 - opening, 1-362
 - patching, 2-1
 - performing a checkpoint operation, 1-131
 - reclaiming, 1-389
 - recovery, 1-391, 1-411
 - single-file databases, 1-401
 - repairing page corruption, 1-415
 - resolving an unresolved transaction, 1-411, 1-426
 - restoring, 1-430
 - from full backup file, 1-430, 1-432
 - from incremental backup file, 1-430, 1-432
 - root file, 1-477
 - uncorrupting, 2-43
 - unloading tables or views, 1-676
 - verifying integrity, 1-738
- Database backup operation, 1-47
- Database buffers, 1-287, 1-294
- Database migration
 - converting to higher version, 1-155
- Database pages
 - checksum verification of, 1-740
 - initializing, 1-418
 - purging unused space from, 1-418
- Database recovery (DBR) process
 - using RMU Recover command, 1-391
- Database table
 - for storing security audit journal records, 1-304, 1-305
- Database users
 - eliminating
 - with RMU Close command, 1-134
- Data structures
 - checking integrity, 1-738
- Data types
 - conversion of by RMU Load command, 1-285t
 - date-time, A-7
 - .rrd file, A-4
- Date-time data type, A-7
- DBR process
 - See* Database recovery (DBR) process
- DEFINE FIELD statement
 - .rrd file, A-1
- DEFINE RECORD statement
 - .rrd file, A-2
- Delete Optimizer_Statistics command, 1-184
 - Column_Group qualifier, 1-185
 - examples, 1-186
 - Log qualifier, 1-185
 - Tables qualifier, 1-185
- Deleting
 - column duplicity factor from optimizer statistics, 1-184
 - null factor statistics from optimizer statistics, 1-184
 - optimizer statistics, 1-184
 - workload statistics, 1-184
- Delimited identifier
 - with RMU Load command, 1-307
 - with RMU Unload command, 1-689
- DEPOSIT command (RdbALTER), 2-9
- DEPOSIT FILE command (RdbALTER), 2-15
- DEPOSIT ROOT command (RdbALTER), 2-17
- DETACH command (RdbALTER), 2-19
- Detaching RdbALTER from a database, 2-19
- Disabling .aij file overwriting, 1-520
- Disabling after-image journaling, 1-520
- Disabling AIJ caching, 1-520
- Disabling DACCESS audit events, 1-540
- Disabling Galaxy features, 1-563
- Disabling logminer, 1-568
- Disabling security alarms, 1-539
- DISPLAY command (RdbALTER), 2-20
- DISPLAY FILE command (RdbALTER), 2-27
- Displaying .aij file in ASCII format, 1-199

- Displaying .oaij file in ASCII format, 1–199
- Displaying .rbr file in ASCII format, 1–224
- Displaying .ruj file in ASCII format, 1–226
- Displaying cardinality statistics, 1–631
- Displaying contents
 - of database root (.rdb) file, 1–188
 - of snapshot (.snp) file, 1–188
 - of storage area (.rda) file, 1–188
- Displaying database information, 1–1, 1–667
- Displaying formatted .unl file in ASCII format, 1–224
- Displaying information about users, 1–669
 - for a cluster, 1–195
 - for a node, 1–669
- Displaying locks, 1–611
- Displaying logical names, 1–629
- Displaying optimizer statistics, 1–631
- Displaying Oracle Rdb version number, 1–672
- Displaying output
 - after-image journal, 1–199
 - backup file, 1–213
 - database, 1–188
 - optimized after-image journal, 1–199
 - recovery-unit journal, 1–226
- Displaying root file ACL, 1–638
- Displaying security audit characteristics, 1–604
- Displaying statistics, 1–641
- Displaying storage statistics, 1–631
- Displaying workload statistics, 1–631
- DISPLAY ROOT command (RdbALTER), 2–29
- Distributed transaction
 - resolving, 1–426
- Documentation
 - conventions, xv
- Domain definition
 - extracting, 1–235
- Dropping after-image journal (.aij) files, 1–520
- Dump After_Journal command, 1–199
 - Active_IO qualifier, 1–200
 - Area qualifier, 1–200
 - Data qualifier, 1–200
 - Encrypt qualifier, 1–201
 - End qualifier, 1–201
 - examples, 1–209
 - First qualifier, 1–201
- Dump After_Journal command (cont'd)
 - Format qualifier, 1–202
 - Label qualifier, 1–203
 - Larea qualifier, 1–203
 - Last qualifier, 1–203
 - Library qualifier, 1–204
 - Line qualifier, 1–205
 - Media_Loader qualifier, 1–205
 - Only qualifier, 1–206
 - Option qualifier, 1–207
 - Output qualifier, 1–208
 - Page qualifier, 1–208
 - Prompt qualifier, 1–208
 - Rewind qualifier, 1–208
 - Start qualifier, 1–208
 - State=Prepared qualifier, 1–208
- Dump Backup_File command, 1–213
 - Active_IO qualifier, 1–214
 - Disk_File qualifier, 1–214
 - Encrypt qualifier, 1–215
 - examples, 1–222
 - Journal qualifier, 1–215
 - Label qualifier, 1–215
 - Librarian qualifier, 1–216
 - Media_Loader qualifier, 1–218
 - Options qualifier, 1–219
 - Output qualifier, 1–220
 - Process qualifier, 1–220
 - Prompt qualifier, 1–221
 - Restore_Options qualifier, 1–221
 - Rewind qualifier, 1–221
 - Skip qualifier, 1–221
- Dump command, 1–188
 - Areas qualifier, 1–189
 - End qualifier, 1–189
 - examples, 1–196
 - Header qualifier, 1–190
 - Lareas qualifier, 1–192
 - Option qualifier, 1–193
 - options file, 1–193
 - Output qualifier, 1–193
 - Restore_Options qualifier, 1–193
 - Snapshots qualifier, 1–193
 - Spams_Only qualifier, 1–194
 - Start qualifier, 1–194

Dump command (cont'd)

- State=Blocked qualifier, 1-194
- Users qualifier, 1-195

Dump Export command, 1-224

- Data qualifier, 1-224
- examples, 1-225
- Output qualifier, 1-224

Dump Recovery_Journal command, 1-226

- Data qualifier, 1-226
- Output qualifier, 1-227

Dump Row_Cache command, 1-228

- Cache_Name qualifier, 1-229
- Data qualifier, 1-229
- Output qualifier, 1-229

Duplicating a database, 1-169

E

Eliminating active users

- RMU Close command, 1-134

Enabling .ajj file overwriting, 1-520

Enabling after-image journaling, 1-520

Enabling AIJ caching, 1-520

Enabling Buffer_Object features, 1-554

Enabling DACCESS audit events, 1-540

Enabling Galaxy features, 1-563

Enabling logminer, 1-568

Enabling security alarms, 1-540

Enabling security auditing, 1-539, 1-540

Exclusive update lock (RdbALTER), 2-6, 2-19

EXIT command (RdbALTER), 2-31

Expiration date

- specifying for .ajj backup file, 1-116
- specifying for database backup file, 1-77
- specifying for optimized .ajj file, 1-381

Export file

- exporting output, 1-224
- RMU Dump Export command, 1-224

External procedure

- extracting, 1-237

Extract command, 1-231

- access control list (ACL) definition, 1-237
- AIJ object definition, 1-234
- character set and, 1-232
- collating sequence, 1-234
- command procedure for database load, 1-236

Extract command (cont'd)

- command procedure for database unload, 1-236
- command procedure for database verify, 1-240
- constraints, 1-235
- contents of catalog created for an SQL multischema database, 1-234
- database, 1-235
- Defaults qualifier, 1-232
- delete protections from ACLs, 1-237
- disabling header output, 1-249
- display profiles, 1-237
- Domains, 1-235
- examples, 1-260
- external function, 1-236
- external procedure, 1-237
- grouping by table, 1-249
- index definition, 1-236
- Items qualifier, 1-234
- Language qualifier, 1-244
- Log qualifier, 1-245
- Options qualifier, 1-245
- Output qualifier, 1-253
- parameters for generated verify command file, 1-241t
- query outline definition, 1-237
- revoke entry, 1-237
- RMU Set Audit command, 1-238
- role definitions, 1-238
- schema definition for SQL multischema database, 1-238
- SQL ALTER SEQUENCE statement, 1-238
- SQL CREATE SEQUENCE statement, 1-238
- SQL IMPORT script, 1-236
- storage map definition, 1-238
- stored procedure and function definition, 1-237
- table definition, 1-239
- trigger, 1-240
- user definitions, 1-240
- using qualifiers to determine output selection, 1-253t
- view, 1-241
- work load, 1-244

F

File extension

- .aij, 1-520
- .aij_rbf, 1-100, 1-199
- default, 1-3
- .oaij, 1-95
- .opt, 1-3
- .plan, 1-127, 1-293, 1-331
- .rbf, 1-50
- .rbr, 1-224
- .rda, 1-51
- .rdb, 1-386, 2-6
- .rrd, 1-15
- .ruj, 1-226
- .snp, 1-71
- .unl, 1-677

File name

- truncation of during backup operation, 1-82

File qualifiers

- See* Parameter qualifiers

File specification

- changing with RdbALTER, 2-15, 2-17
- DEPOSIT FILE command, 2-15
- indirect, 1-3

Format

- conventions, xii

Function

- extracting, 1-236

G

Galaxy features

- disabling, 1-563
- enabling, 1-563

Gathering statistics

- for the optimizer, 1-140
- on database logical area space, 1-13
- on database page space, 1-13
- on database storage area space, 1-13
- on index structure, 1-28
- on row placement relative to index structures, 1-39

Global buffers, 1-170, 1-443

Global process symbols, 1-98, 1-599

H

Help command, 1-11

HELP command (RdbALTER), 2-33

I

Importing data, 1-236, 1-280

Improving sequential access performance, 1-418

Index

- analyzing, 1-28
- analyzing placement of, 1-40
- disabled
 - analyzing cardinality of, 1-24
 - analyzing placement of, 1-40
 - analyzing structure of, 1-30
- RMU Load command and, 1-290
- showing statistics
 - on index structure, 1-28
 - RMU Show Statistics command, 1-641

Index definition

- extracting, 1-236

Index keys

- compressed
 - analyzing, 1-32
 - compression ratio of, 1-30

Indirect command file, 1-3

Initializing CSN values, 1-483

Initializing database pages, 1-418

Initializing TSN values, 1-483

Inserting

- column duplicity factor into optimizer
 - statistics, 1-272
- null factor statistics into optimizer statistics, 1-272
- optimizer statistics, 1-272
- workload statistics, 1-272

Insert Optimizer_Statistics command, 1-272

Column_Group qualifier, 1-273

Duplicity_Factor qualifier, 1-273

examples, 1-274

Log qualifier, 1-273

Insert Optimizer_Statistics command (cont'd)
 Null_Factor qualifier, 1-273
 Tables qualifier, 1-273
Invoking RdbALTER utility, 1-11
Invoking the Performance Monitor, 1-641

J

Journal
 security audit, 1-539
Journaling
 after-image (.aij) file
 automatic, 1-432
 mechanism described, 1-95
 using to recover a database, 1-391

L

Librarian command, 1-277
 List qualifier, 1-277
 Remove Qualifier, 1-279
LIST OF BYTE VARYING data
 repairing corruption to, 1-415
Load command, 1-280
 Audit qualifier, 1-286
 Buffers qualifier, 1-287
 case sensitivity and, 1-307
 character sets and, 1-307
 Commit_Every qualifier, 1-287
 constraint evaluation, 1-288
 Constraints qualifier, 1-288
 constraint violations and, 1-297
 Corresponding qualifier, 1-290
 Defer_Index_Updates qualifier, 1-290
 delimited identifier and, 1-307
 delimited text null string, 1-298
 delimited text prefix string, 1-297
 delimited text separator string, 1-297
 delimited text suffix string, 1-298
 delimited text terminator string, 1-298
 examples, 1-309
 Execute qualifier, 1-291
 Fields qualifier, 1-292
 List_Plan=output-file qualifier, 1-292
 Log_Commits qualifier, 1-293
 Match_Name qualifier, 1-293

Load command (cont'd)
 null value, 1-298
 Parallel qualifier, 1-294
 Place qualifier, 1-295
 Record_Definition qualifier, 1-295
 Restricted_Access qualifier, 1-300
 Rms_Record_Def qualifier, 1-299
 Row_Count qualifier, 1-300
 Skip qualifier, 1-300
 Statistics qualifier, 1-301
 syntax for .rrd file, A-1
 Transaction_Type qualifier, 1-302
 Trigger_Relations qualifier, 1-302
 .unl file
 and Oracle Rdb version, 1-303
 version of .unl file, 1-303
 with character set, 1-307
Loading relations, 1-280, 1-331
Loading rows into an existing table, 1-280
Loading tables, 1-280, 1-331
 from security audit journal, 1-284
 generating a command procedure for, 1-236
Load Plan command
 examples, 1-332
 Execute qualifier, 1-331
 List_Plan qualifier, 1-332
Local buffers, 1-170, 1-448
Local symbol
 RMU\$RDB_VERSION, 1-673
Lock mode compatibility, 1-620t
Lock qualifier combinations, 1-612t
Locks
 database, 1-611
 process, 1-611
Lock timeout for quiet point
 specifying the duration of, 1-69, 1-111
LOG command (RdbALTER), 2-34
Log file
 closing, 1-337
Logical name
 nonconcealed rooted, 1-357, 1-458
 RDM\$BIND_ABS_QUIET_POINT, 1-534
 RDM\$BIND_AIJ_WORK_FILE, 1-383, 1-402
 RDM\$BIND_BUFFERS, 1-287
 RDM\$BIND_DBR_WORK_FILE, 1-383,
 1-402

Logical name (cont'd)

RDM\$BIND_SNAP_QUIET_POINT, 1-79
RDMS\$BIND_SORT_WORKFILES, 1-295,
1-383, 1-751

Logical names

displaying, 1-629

LogMiner for Rdb

See the Unload After_Journal command
disabling, 1-568
enabling, 1-568
information returned, B-3
minimize application downtime, B-6
record definition prefix, B-5
restrictions and limitations, B-2
segmented string columns, B-6
table definition prefix, B-6
transaction table, B-5
using an OpenVMS pipe, B-8

M

MAKE CONSISTENT command (RdbALTER),
2-35

Managing .ajj files, 1-95

Modifying .ajj files, 1-520

Modifying root file ACLs, 1-569

Monitor buffers available, 1-669

Monitor log specification, 1-669

Monitor process

closing log file, 1-337

refreshing log file, 1-337

starting, 1-339

stopping, 1-343

Monitor Reopen_Log command, 1-337

examples, 1-338

Monitor Start command, 1-339

examples, 1-342

Output qualifier, 1-339

Priority qualifier, 1-340

Swap qualifier, 1-340

Monitor Stop command, 1-343

Abort qualifier, 1-343

examples, 1-345

using with Oracle Trace, 1-344

Wait qualifier, 1-344

MOVE command (RdbALTER), 2-37

Move_Area command, 1-346

After_Journal qualifier, 1-347

Ajj_Options qualifier, 1-348

All_Areas qualifier, 1-349

Area qualifier, 1-349

Blocks_Per_Page qualifier, 1-354

Cdd_Integrate qualifier, 1-350

Checksum_Verification qualifier, 1-350

Directory qualifier, 1-351

examples, 1-358

Extension qualifier, 1-354

File qualifier, 1-354

Log qualifier, 1-351

Nodes_Max qualifier, 1-351

Online qualifier, 1-351

Option qualifier, 1-352

Page_Buffers qualifier, 1-352

Path qualifier, 1-352

Quiet_Point qualifier, 1-353

Read_Only qualifier, 1-355

Read_Write qualifier, 1-355

Root qualifier, 1-353

Snapshots qualifier, 1-355

Spams qualifier, 1-356

Thresholds qualifier, 1-356

Users_Max qualifier, 1-353

Moving a database, 1-346, 2-1

See also Move_Area command

Moving a root file, 1-346

Moving storage areas, 1-346

Multinational character set, A-6

Multischema database

extracting contents of, 1-234

extracting schema definitions, 1-238

Multithreaded backup, 1-48

N

NOLOG command (RdbALTER), 2-38

Nonconcealed rooted logical name

using to create database files, 1-357, 1-458

Null value

RMU Load command and, 1-298

RMU Unload command and, 1-684

O

- .oaij file
 - See Optimized after-image journal (.oaij) file
 - Object
 - auditing, 1-541
 - for specific privileges, 1-542
 - Object types
 - auditing, 1-541
 - for specific privileges, 1-542
 - Open command, 1-362
 - Access qualifier, 1-363
 - examples, 1-368
 - Global_Buffers qualifier, 1-365
 - Path qualifier, 1-366
 - Row_Cache=Disable qualifier, 1-366
 - Statistics qualifier, 1-367
 - Wait qualifier, 1-367
 - Opening databases, 1-362
 - Opening root files, 1-81
 - OpenVMS security audit journal
 - loading into database, 1-284
 - Optimize After_Journal command, 1-369
 - Accept_Label qualifier, 1-372
 - Active_IO qualifier, 1-372
 - Block_Size qualifier, 1-372
 - Crc=Autodin_II qualifier, 1-373
 - Crc=Checksum qualifier, 1-373
 - Density qualifier, 1-373
 - Encrypt qualifier, 1-376
 - examples, 1-385
 - Format qualifier, 1-376
 - Group_Size qualifier, 1-377
 - Label qualifier, 1-378
 - Librarian qualifier, 1-378
 - Log qualifier, 1-379
 - Media_Loader qualifier, 1-379
 - Nocrc qualifier, 1-373
 - Owner_Uic qualifier, 1-380
 - Protection qualifier, 1-380
 - Recovery_Method qualifier, 1-381
 - Rewind qualifier, 1-381
 - Tape_Expiration qualifier, 1-381
 - Trace qualifier, 1-382
 - Optimized after-image journal (.oaij) file
 - displaying output, 1-199
 - Optimizer statistics
 - collecting, 1-140
 - deleting, 1-184
 - displaying, 1-631
 - inserting, 1-272
 - Optimizing after-image journal (.aij) files, 1-369
 - logging, 1-379
 - to tape
 - See *Tape*, 1-372
 - tracing, 1-382
 - Optional root file parameter
 - RMU Alter command, 2-1
 - Oracle Media Management
 - Librarian qualifier, 1-65, 1-109, 1-204, 1-216, 1-378, 1-397, 1-445, 1-485
 - Oracle Rdb metadata
 - decoding, 1-231
 - extracting, 1-231
 - reading, 1-231
 - Oracle RMU command syntax, xii
 - Oracle Trace software
 - interaction with RMU Monitor Stop command, 1-344
 - Overwriting after-image journal (.aij) files, 1-520
- ## P
-
- Page buffers, 1-72, 1-172, 1-352, 1-451
 - PAGE command (RdbALTER), 2-39, 2-44e
 - Pages
 - setting to consistent, 1-557
 - setting to corrupt, 1-557
 - Parallel backup, 1-48
 - Parallel backup plan file, 1-127
 - Parallel load, 1-280, 1-294
 - Parameter qualifiers, 1-2
 - defined, 1-2
 - positional semantics of, 1-2
 - Parameters
 - for Oracle RMU commands, 1-1

- Patching databases, 2-1
- Performance Monitor, 1-641
- Plan file
 - RMU Backup Plan command and, 1-127
 - RMU Load Plan command and, 1-331
- Populate_Cache command
 - Index qualifier, 1-386
 - Log qualifier, 1-387
 - Only_Cached qualifier, 1-387
 - Statistics_Interval qualifier, 1-387
 - Table qualifier, 1-387
 - Transaction_Type qualifier, 1-387
- Positional qualifiers
 - See* Parameter qualifiers
- Privilege
 - creating, 1-569
 - deleting, 1-569
 - modifying, 1-569
 - required for using Oracle RMU commands, 1-4t
- Procedure
 - extracting, 1-237
- Process locks, 1-611
- Process statistics, 1-641
- Profiles
 - extracting, 1-237
- Purging unused space
 - from database pages, 1-418

Q

- Qualifiers
 - case sensitivity of, 1-2
 - for Oracle RMU commands, 1-2
 - positional, 1-2
 - using indirect command files, 1-3
- Query outline definition
 - extracting, 1-237
- Quiet-point-lock timeout
 - specifying the duration of, 1-69, 1-111

R

- RADIX command (RdbALTER), 2-40
- RAID technology, 1-350
- RDB\$INDICES system table, 1-631
 - displaying rows in, 1-140
- RDB\$RELATIONS system table, 1-631
 - displaying rows in, 1-140
- RDB\$WORKLOAD system table, 1-631
 - deleting rows from, 1-184
 - displaying rows in, 1-140
 - inserting rows into, 1-272
- RdbALTER
 - altering data fields, 2-9
 - attaching to a database, 2-6
 - changing area (.rda) and snapshot (.snp) file specifications, 2-15
 - changing recovery-unit journal (.ruj) file specification, 2-17
 - changing root (.rdb) file specification, 2-17
 - commands, 2-2
 - AREA . . . PAGE, 2-4
 - ATTACH, 2-6
 - COMMIT, 2-8
 - DEPOSIT, 2-9
 - DEPOSIT FILE, 2-15
 - DEPOSIT ROOT, 2-17
 - DETACH, 2-19
 - DISPLAY, 2-20
 - DISPLAY FILE, 2-27
 - DISPLAY ROOT, 2-29
 - EXIT, 2-31
 - HELP, 2-33
 - LOG, 2-34
 - MAKE CONSISTENT, 2-35
 - MOVE, 2-37
 - NOLOG, 2-38
 - PAGE, 2-39
 - RADIX, 2-40
 - ROLLBACK, 2-41
 - UNCORRUPT, 2-42
 - VERIFY, 2-44
 - command syntax, 2-1
 - committing changes, 2-8

RdbALTER (cont'd)

- detaching from a database, 2–19
- displaying area (.rda) or snapshot (.snp) file specifications, 2–27
- displaying data fields, 2–20
- displaying recovery-unit journal (.ruj) file specifications, 2–29
- displaying root (.rdb) file specifications, 2–29
- ending the session, 2–31
- exclusive update lock, 2–6, 2–19
- fetching pages, 2–39
- getting information on, 2–33
- invoking, 1–11
- keeping an audit trail, 2–34
- moving data, 2–37
- patching fields, 2–9
- resetting an inconsistent flag, 2–35
- resetting the corruption flag, 2–42
- setting default radix, 2–40
- specifying a page, 2–4
- specifying a snapshot area, 2–4
- specifying a storage area, 2–4
- static verification, 2–44
- stopping logging, 2–38
- undoing changes, 2–41
- verifying a page, 2–44

RDM\$BIND_ABS_QUIET_POINT logical name, 1–534

RDM\$BIND_AIJ_INITIALIZE_IO_COUNT logical name, 1–122

RDM\$BIND_AIJ_INITIALIZE_IO_SIZE logical name, 1–122

RDM\$BIND_AIJ_WORK_FILE logical name, 1–383, 1–402

RDM\$BIND_BUFFERS logical name, 1–287

RDM\$BIND_DBR_WORK_FILE logical name, 1–383, 1–402

RDM\$BIND_SNAP_QUIET_POINT logical name, 1–79

RDM\$BIND_SORT_WORKFILES logical name

RMU Load command, 1–295

RMU Optimize After_Journal command, 1–383

RMU Verify command, 1–751

Reclaim command, 1–389

- Area qualifier, 1–389
- Log qualifier, 1–389

Recover command, 1–391

- Active_IO qualifier, 1–393
- Aij_Buffers qualifier, 1–393
- Areas qualifier, 1–393
- Automatic qualifier, 1–395
- Encrypt qualifier, 1–395
- examples, 1–405
- Format qualifier, 1–395
- Just_Corrupt qualifier, 1–396
- Just_Pages qualifier, 1–396
- Label qualifier, 1–396
- Librarian qualifier, 1–397
- Log qualifier, 1–398
- Media Loader qualifier, 1–398
- Online qualifier, 1–399
- Order_Aij_Files qualifier, 1–399
- Output qualifier, 1–399
- Prompt qualifier, 1–399
- reentering lost transactions, 1–391
- Resolve qualifier, 1–399
- Rewind qualifier, 1–400
- Root qualifier, 1–400
- Trace qualifier, 1–401
- Until qualifier, 1–401

Recover Resolve command, 1–411

- Confirm qualifier, 1–412
- examples, 1–413
- State qualifier, 1–412

Recovery of .aij files

- during a restore operation, 1–430

Recovery of databases, 1–391

- single-file, 1–401
- specifying new location for root file, 1–400
- specifying time limits, 1–401

Recovery-unit journal (.ruj) file

- displaying file specification, 2–29
- displaying output, 1–226

Redundant arrays of inexpensive disks (RAID) technology, 1–350

Reopening the AIJ log server (ALS) output file, 1-507

Repair command, 1-415
Abm qualifier, 1-416
All_Segments qualifier, 1-416
Areas qualifier, 1-417
Checksum qualifier, 1-417
correcting AIP entries, 1-422
examples, 1-424
Initialize qualifier, 1-417
Spams qualifier, 1-422
Tables qualifier, 1-422

Repairing ABM pages, 1-416
Repairing database page corruption, 1-415
Repairing segmented string corruption, 1-415
Repairing SPAM page corruption, 1-422
Repairing storage areas, 1-417
Replicating a database, 1-165

Required privileges
See Privilege

Reserving after-image journal (.aij) files
using RMU Convert command, 1-159
using RMU Copy_Database command, 1-167
using RMU Move_Area command, 1-348
using RMU Restore command, 1-439
using RMU Restore Only_Root command, 1-482
using RMU Set After_Journal command, 1-520

Reserving storage area (.rda) files
using RMU Convert command, 1-159

Resolve command, 1-426
Confirm qualifier, 1-427
examples, 1-428
Log qualifier, 1-427
Parent_Node qualifier, 1-427
Process qualifier, 1-427
State qualifier, 1-428
Tsn qualifier, 1-428

Resolving an unresolved database transaction, 1-411, 1-426

Restore command, 1-430
Acl qualifier, 1-437
Active_IO qualifier, 1-437
After_Journal qualifier, 1-437

Restore command (cont'd)

Aij_Options qualifier, 1-439
Area qualifier, 1-439
Blocks_Per_Page qualifier, 1-455
by area, 1-436, 1-440
calling RMU Convert command, 1-430
Cdd_Integrate qualifier, 1-441
Close_Wait qualifier, 1-169, 1-441
Commit qualifier, 1-441
Confirm qualifier, 1-442
Directory qualifier, 1-442
Disk_File qualifier, 1-442
Duplicate qualifier, 1-443
Encrypt qualifier, 1-443
examples, 1-463
Extension qualifier, 1-455
File qualifier, 1-455
generating an options file for
 using the RMU Backup command, 1-75
 using the RMU Dump Backup command, 1-221
 using the RMU Dump command, 1-193
Global_Buffers qualifier, 1-443
Incremental qualifier, 1-444
Journal qualifier, 1-444
Just_Corrupt qualifier, 1-456
Just_Pages qualifier, 1-457
Label qualifier, 1-445
Librarian qualifier, 1-445
Loader_Synchronization qualifier, 1-447
Local_Buffers qualifier, 1-448
Log qualifier, 1-449
Master qualifier, 1-449
Media Loader qualifier, 1-449
New_Version qualifier, 1-450
Nodes_Max qualifier, 1-450
Online qualifier, 1-450
Open_Mode qualifier, 1-451
Options qualifier, 1-451
Page_Buffers qualifier, 1-451
Path qualifier, 1-452
Prompt qualifier, 1-452
Read_Only qualifier, 1-458
Read_Write qualifier, 1-458
Recovery qualifier, 1-452

Restore command (cont'd)

- Rewind qualifier, 1-453
 - Root qualifier, 1-453
 - Snapshot qualifier, 1-458
 - Spams qualifier, 1-459
 - Thresholds qualifier, 1-459
 - Transaction_Mode qualifier, 1-453
 - Users_Max qualifier, 1-454
 - Volumes qualifier, 1-455
- ## Restore Only_Root command, 1-477
- Active_IO qualifier, 1-481
 - After_Journal qualifier, 1-481
 - Aij_Options qualifier, 1-482
 - Blocks_Per_Page qualifier, 1-491
 - Directory qualifier, 1-483
 - examples, 1-495
 - File qualifier, 1-491
 - Initialize_Tsns qualifier, 1-483
 - Label qualifier, 1-484
 - Librarian qualifier, 1-485
 - Log qualifier, 1-486
 - Media_Loader qualifier, 1-486
 - New_Snapshots qualifier, 1-487
 - Nodes_Max qualifier, 1-487
 - Noset_Tsn qualifier, 1-488
 - Options qualifier, 1-487
 - Read_Only qualifier, 1-492
 - Read_Write qualifier, 1-492
 - Rewind qualifier, 1-487
 - Root qualifier, 1-488
 - Set_Tsn qualifier, 1-488
 - Snapshot qualifier, 1-492
 - Spams qualifier, 1-492
 - Thresholds qualifier, 1-493
 - Transaction_Mode qualifier, 1-489
 - Update_Files qualifier, 1-490
 - Users_Max qualifier, 1-490
- ## Restore operation
- See also* Restore command, Restore Only_Root command
- automatic .aij file recovery and, 1-430
 - by area, 1-436, 1-439, 1-440
 - full restore operation, 1-432
 - incremental restore operation, 1-432
 - automatic .aij recovery and, 1-461

Restoring a database, 1-430

- See also* Restore command, Restore Only_Root command
 - from a backup file, 1-430
 - from an incremental backup file, 1-432
 - from by-area backup files, 1-477
 - from tape
 - improving performance of, 1-437, 1-444
 - root file, 1-477
- ## Resuming suspended AIJ backup operations, 1-513
- RMU\$FLAGS bits, 1-35t, 1-45t
 - RMU\$RDB_VERSION local symbol, 1-673
- ## RMU Alter command, 1-11
- See also* RdbAlter
- correcting AIP entries, 1-422
 - invoking the RdbALTER utility, 1-11
- ## ROLLBACK command (RdbALTER), 2-41
- ## Root file
- displaying contents, 1-188
 - moving, 1-346
 - problems opening, 1-81
 - restoring, 1-477
- ## Root file ACL
- displaying, 1-638
 - modifying, 1-569
- ## .rrd file
- data types, A-4
 - DEFINE FIELD statement, A-1
 - DEFINE RECORD statement, A-2
 - syntax of, A-1, A-7
- ## .ruj file
- See* Recovery-unit journal (.ruj) file

S

Security alarms, 1-539

- disabling, 1-539
- enabling, 1-540

Security auditing

- disabling, 1-539
- displaying characteristics, 1-604
- enabling, 1-539, 1-540
- starting, 1-544
- stopping, 1-545

- Security audit journal, 1-539
 - loading into database, 1-284
- Security audit journal records
 - creating a database for storing, 1-304
 - creating a table for storing, 1-304, 1-305
- Segmented strings
 - repairing corruption to, 1-415
 - verifying, 1-746
- Sequential access
 - improving performance of, 1-418
- Server After_Journal Reopen_Output command, 1-507
 - examples, 1-508
 - reopening the AIJ log server (ALS) output file, 1-507
- Server After_Journal Start command, 1-509
 - examples, 1-510
 - Output qualifier, 1-509
 - starting the AIJ log server (ALS), 1-509
- Server After_Journal Stop command, 1-511
 - examples, 1-512
 - Output qualifier, 1-511
 - stopping the AIJ log server (ALS), 1-511
- Server Backup_Journal Resume command, 1-513
 - examples, 1-514
 - Log qualifier, 1-513
 - resuming suspended AIJ backup operations, 1-513
- Server Backup_Journal Suspend command, 1-515
 - examples, 1-516
 - Log qualifier, 1-516
 - suspending AIJ backup operations, 1-515
- Server Record_Cache Checkpoint command, 1-518
 - Log qualifier, 1-518
 - Wait qualifier, 1-519
- Set After_Journal command, 1-520
 - Add qualifier, 1-521
 - AIJ_Options qualifier, 1-523
 - Allocation qualifier, 1-523
 - Alter qualifier, 1-524
 - Backups qualifier, 1-525
 - Cache qualifier, 1-528
- Set After_Journal command (cont'd)
 - changing .aij file specification, 1-520
 - Disable qualifier, 1-528
 - Drop qualifier, 1-528
 - Enable qualifier, 1-529
 - examples, 1-535
 - Extent qualifier, 1-529
 - Log qualifier, 1-529
 - Notify qualifier, 1-529
 - Overwrite qualifier, 1-531
 - Reserve qualifier, 1-531
 - Shutdown_Timeout qualifier, 1-532
 - Suppress qualifier, 1-532
 - Switch_Journal qualifier, 1-533
- Set Audit command, 1-539
 - Disable qualifier, 1-539
 - Enable qualifier, 1-540
 - Every qualifier, 1-544
 - examples, 1-547
 - extracting, 1-238
 - First qualifier, 1-544
 - Flush qualifier, 1-544
 - Start qualifier, 1-544
 - Stop qualifier, 1-545
 - Type=Alarm option, 1-545
 - Type=Audit option, 1-545
 - Type qualifier, 1-545
- Set Buffer_Object command, 1-554
 - example, 1-556
- Set Corrupt_Pages command, 1-557
 - Area qualifier, 1-559
 - Consistent qualifier, 1-560
 - Corrupt qualifier, 1-560
 - Disk qualifier, 1-560
 - examples, 1-561
 - Page qualifier, 1-560
- Set Galaxy command, 1-563
 - example, 1-564
- Set Global_Buffers command, 1-565
 - Disabled qualifier, 1-565
 - Enabled qualifier, 1-565
 - Large_Memory qualifier, 1-566
 - Log qualifier, 1-566
 - Number qualifier, 1-566
 - User_Limit qualifier, 1-566

- Set Logminer command, 1-567
 - examples, 1-568
- Set Privilege command, 1-569
 - Acl qualifier, 1-571
 - Acl_File qualifier, 1-572
 - After qualifier, 1-572
 - Delete qualifier, 1-572
 - Edit qualifier, 1-572
 - examples, 1-577
 - Header qualifier, 1-638
 - Journal qualifier, 1-573
 - Keep qualifier, 1-573
 - Like qualifier, 1-573
 - Log qualifier, 1-573
 - Mode qualifier, 1-573
 - New qualifier, 1-574
 - Recover qualifier, 1-574
 - Replace qualifier, 1-574
- Set Row_Cache command, 1-582
 - Alter=Rad_Hint qualifier, 1-583
 - Alter=Type option, 1-583
 - Alter qualifier, 1-582
 - Disable qualifier, 1-584
 - Enable qualifier, 1-584
 - examples, 1-230, 1-585
- Set Server command, 1-587
- Set Server Output command
 - examples, 1-589
 - Log qualifier, 1-588
- Set Shared_Memory command, 1-590
 - Log qualifier, 1-590
 - Rad_Hint qualifier, 1-590
 - Type=Process option, 1-591
 - Type=Resident option, 1-591
 - Type=System option, 1-591
 - Type qualifier, 1-591
- Setting CSN values, 1-478, 1-482, 1-483, 1-488, 1-495
- Setting TSN values, 1-478, 1-482, 1-483, 1-488, 1-495
- Show After_Journal command, 1-594
 - Backup_Context qualifier, 1-599
 - examples, 1-601
 - Output qualifier, 1-600
- Show Audit command, 1-604
 - All qualifier, 1-604
 - Daccess qualifier, 1-605
 - Every qualifier, 1-605
 - examples, 1-606
 - Flush qualifier, 1-605
 - Identifiers qualifier, 1-605
 - Output qualifier, 1-605
 - Protection qualifier, 1-605
 - Rmu qualifier, 1-605
 - Type=Alarm option, 1-605
 - Type=Audit option, 1-605
- Show command, 1-593
 - See also* specific Show commands
- Show Corrupt_Pages command, 1-609
 - examples, 1-610
 - Options qualifier, 1-609
 - Output qualifier, 1-609
- Show Locks command, 1-611
 - Lock qualifier, 1-614
 - Mode qualifier, 1-614
 - Options qualifier, 1-615
 - Output qualifier, 1-616
 - Process qualifier, 1-616
 - Resource_type qualifier, 1-617
- Show Logical_Names command, 1-629
 - Output qualifier, 1-629
 - Undefined qualifier, 1-629
- Show Optimizer_Statistics command, 1-631
 - examples, 1-635
 - Full qualifier, 1-631
 - Index qualifier, 1-632
 - Log qualifier, 1-632
 - Statistics qualifier, 1-632
 - System_Relations qualifier, 1-633
 - Tables qualifier, 1-633
 - Threshold qualifier, 1-634
- Show Privilege command, 1-638
 - examples, 1-639
 - Expand_All qualifier, 1-638
- Show Statistics command, 1-641
 - Alarm qualifier, 1-645
 - Broadcast qualifier, 1-645
 - Cluster qualifier, 1-646
 - Configure qualifier, 1-647

- Show Statistics command (cont'd)
 - Cycle qualifier, 1-647
 - Dbkey_Log qualifier, 1-647
 - Deadlock_Log qualifier, 1-648
 - exiting display, 1-662
 - Histogram qualifier, 1-649
 - Input qualifier, 1-650
 - Interactive qualifier, 1-650
 - Lock_Timeout_Log qualifier, 1-651
 - Logical_Area qualifier, 1-652
 - Log qualifier, 1-652
 - Notify qualifier, 1-653
 - Opcom_Log qualifier, 1-654
 - Options qualifier, 1-655
 - Output qualifier, 1-657
 - Prompt_Timeout qualifier, 1-658
 - Reopen_Interval qualifier, 1-658
 - Reset qualifier, 1-659
 - Screen qualifier, 1-659
 - Stall_Log qualifier, 1-660
 - Time qualifier, 1-660
 - Until qualifier, 1-661
- Show System command, 1-667
 - available monitor message buffers, 1-667
 - examples, 1-668
 - Output qualifier, 1-667
- Show Users command, 1-669
 - available monitor message buffers, 1-669
 - examples, 1-670
 - Output qualifier, 1-669
- Show Version command, 1-672
 - examples, 1-673
 - Output qualifier, 1-672
- Shutdown timeout
 - displaying
 - using RMU Show After_Journal command, 1-597
 - setting
 - using RMU Set After_Journal command, 1-520, 1-532
- Single-file database
 - recovery of, 1-401
- Snapshot (.snp) file
 - displaying contents, 1-188
 - moving, 1-458
- Snapshot area
 - specifying with RdbALTER utility, 2-4
- Snapshot pages
 - checksum verification of, 1-746
- Space area management (SPAM) page
 - See SPAM page
- SPAM page
 - dumping, 1-194
 - output from RMU Verify command, 1-738
 - repairing, 1-422
- SQL ALTER SEQUENCE statement
 - extracting, 1-238
- SQL CREATE SEQUENCE statement
 - extracting, 1-238
- SQL IMPORT script
 - extracting, 1-236
- Starting security auditing, 1-544
- Starting the AIJ log server (ALS), 1-509
- Starting the monitor, 1-339
- Statistics
 - collecting for the optimizer, 1-140
 - database, 1-641
 - displaying those used by the optimizer, 1-631
 - gathering
 - on database page space, 1-13
 - on index structure, 1-28
 - on logical area space, 1-13
 - on row placement relative to index structures, 1-39
 - on storage area space, 1-13
 - process, 1-641
- Stopping security auditing, 1-545
- Stopping the AIJ log server (ALS), 1-511
- Stopping the monitor process, 1-343
- Storage allocation
 - improving, 1-422
- Storage area
 - displaying contents, 1-188
 - moving, 1-346
 - repairing, 1-417
 - reserving, 1-159
 - specifying with RdbALTER utility, 2-4
- Storage map definition
 - extracting, 1-238

- Storage statistics
 - collecting, 1–140
- Stored function
 - extracting, 1–237
- Stored procedure
 - extracting, 1–237
- Suppressing use of after-image journal (.ajj) file, 1–520
- Suspending AIJ backup operations, 1–515
- Symbols
 - process, 1–98, 1–599
- Syntax diagram, reading, xii

T

- Table
 - loading data into, 1–280
 - unloading from the database, 1–676
- Table definition
 - extracting, 1–239
- Tape
 - backing up .ajj files to, 1–98, 1–99
 - backing up database to, 1–82
 - backing up to
 - accepting current tape labels and, 1–53, 1–100
 - database backup file name length and, 1–51
 - identifying volumes
 - for dump of database backup file, 1–219
 - improving performance of
 - dump of database backup file, 1–215
 - improving reliability of
 - database backup file on, 1–55
 - for .ajj backup file on, 1–103
 - for optimized .ajj file on, 1–373
 - maximum number of read operations
 - for dump of .ajj backup, 1–200
 - for dump of database backup, 1–214
 - for recovery operation, 1–393
 - maximum number of write operations to
 - for database backup, 1–54
 - optimizing ajj file to
 - accepting current tape labels and, 1–372
 - parallel backup to, 1–48, 1–72
 - preloading

- Tape
 - preloading (cont'd)
 - for a database backup operation, 1–68
 - for a database restore operation, 1–447
 - protection
 - on .ajj backup file, 1–113
 - on database backup file, 1–74
 - on optimized .ajj file, 1–380
 - recovering .ajj file from
 - accepting current tape labels and, 1–398
 - rewinding
 - before .ajj backup operation begins, 1–115
 - before database backup operation begins, 1–76
 - before dump of database backup file begins, 1–221
 - before optimization of .ajj backup file begins, 1–381
 - before recovery operation begins, 1–400
 - before restore-only-root operation begins, 1–487
 - before restore operation begins, 1–453
 - rewinding before dump of .ajj backup file begins, 1–208
 - specifying a journal file to improve restore performance, 1–63
 - specifying concurrent access
 - for a restore operation, 1–455
 - specifying density
 - for .ajj backup file on, 1–103
 - for database backup file on, 1–56
 - for optimized .ajj file on, 1–373
 - specifying expiration date
 - for .ajj backup file, 1–116
 - for database backup file, 1–77
 - for optimized .ajj file, 1–381
 - specifying format
 - for .ajj backup file, 1–106
 - for .ajj backups, 1–119, 1–120
 - for optimized .ajj file, 1–376
 - for recovery operation, 1–395
 - specifying format for dump of .ajj backup file, 1–202
 - specifying labels

Tape

- specifying labels (cont'd)
 - for .aij backup file, 1–108
 - for database backup file, 1–64
 - for dump of .aij backup file, 1–203
 - for dump of database backup file, 1–215
 - for optimized .aij file, 1–378
 - for recovery operation, 1–396
 - for restore-only-root operation, 1–484
 - for restore operation, 1–445
- specifying maximum number of blocks
 - for database backup file, 1–54
 - for optimized .aij file, 1–372
- specifying owner of
 - .aij backup file, 1–112
 - database backup file, 1–72
 - optimized .aij file, 1–380
- XOR recovery blocks
 - for .aij backup file, 1–107
 - for database backup file, 1–61
 - for optimized .aij file, 1–377

Tape device

- alerting RMU to presence or absence of
 - for .aij backup file, 1–111, 1–218
 - for database backups, 1–70
 - for dump of .aij backups, 1–205
 - for optimized .aij file, 1–379
 - for restore-only-root operation, 1–486
 - for restore operation, 1–449

Tape drive

- allocating
 - for .aij backup file, 1–121
 - for database backup file, 1–78
- designating a master
 - for database backup operation, 1–70
 - for database restore operation, 1–449

Tape labels

- accepting current labels, 1–53, 1–100, 1–372

Temporary work file

- AIJ
 - location of, 1–383, 1–402

Transaction

- See* Unresolved transaction, Distributed transaction

Transaction Sequence Number (TSN)

- See* TSN values

Trigger

- extracting, 1–240

Truncation

- of file name during backup operation, 1–82

TSN values, 1–421, 1–428, 1–483, 1–488

- initializing, 1–483
- setting, 1–478, 1–482, 1–483, 1–488, 1–495

U

UNCORRUPT command (RdbALTER), 2–42

.unl file, 1–282, 1–676

Unload After Journal command, 1–702

- Before qualifier, 1–705
 - Continuous qualifier, 1–705
 - enable for LogMiner extraction, 1–703
 - examples, 1–725
 - Extend_Size qualifier, 1–706
 - Format qualifier, 1–707
 - Ignore qualifier, 1–710
 - Include=Action qualifier, 1–711
 - IO_Buffers qualifier, 1–713
 - Log qualifier, 1–713
 - Options qualifier, 1–713
 - Order_AIJ_Files qualifier, 1–714
 - Output qualifier, 1–714
 - Parameter qualifier, 1–715
 - Restart qualifier, 1–715
 - Restore_Metadata qualifier, 1–716
 - Save_Metadata qualifier, 1–716
 - Select qualifier, 1–716
 - Since qualifier, 1–717
 - Sort_Workfiles qualifier, 1–717
 - Statistics_Interval qualifier, 1–717
 - Symbols qualifier, 1–718
 - Table qualifier, 1–718
 - Trace qualifier, 1–719
- ### Unload command, 1–676
- Allocation qualifier, 1–677
 - Buffers qualifier, 1–678
 - case sensitivity and, 1–689
 - Commit_Every qualifier, 1–678
 - Delete_Rows qualifier, 1–678

- Unload command (cont'd)
 - delimited identifier and, 1-689
 - Error_Delete qualifier, 1-678
 - examples, 1-691
 - Extend_Quantity qualifier, 1-679
 - Fields qualifier, 1-679
 - Flush qualifier, 1-679
 - Limit_To qualifier, 1-680
 - null value, 1-684
 - Optimize qualifier, 1-680
 - Record_Definition qualifier, 1-682
 - Reopen_Count qualifier, 1-685
 - Rms_Record_Def qualifier, 1-685
 - Row_Count qualifier, 1-685
 - Statistics_Interval qualifier, 1-685
 - syntax for .rrd file, A-7
 - Transaction_Type qualifier, 1-254, 1-686
 - viewing contents of .unl file, 1-224
 - Virtual_Fields qualifier, 1-687
 - with character set, 1-689
- Unloading tables, 1-676
- Unloading views, 1-676
- Unresolved transaction
 - aborting in the .aj file, 1-411
 - committing in the .aj file, 1-411
 - displaying a list of, 1-194
 - resolving, 1-411, 1-426
- Upgrading software version
 - with RMU Convert command, 1-155
- Users
 - displaying information about, 1-669

V

- Verb
 - locks, 1-611
 - statistics, 1-641
- Verify command, 1-738
 - All qualifier, 1-739
 - Areas qualifier, 1-739
 - Checksum_Only qualifier, 1-740
 - Constraints qualifier, 1-740
 - Data qualifier, 1-741
 - End qualifier, 1-742
 - examples, 1-751
 - Functions qualifier, 1-742

- Verify command (cont'd)
 - Incremental qualifier, 1-742
 - Indexes qualifier, 1-743
 - Lareas qualifier, 1-743
 - Log qualifier, 1-744
 - Output qualifier, 1-744
 - Root qualifier, 1-745
 - Routines qualifier, 1-745
 - Segmented_Strings qualifier, 1-746
 - Snapshots qualifier, 1-746
 - Start qualifier, 1-747
 - Transaction_Type qualifier, 1-747
- VERIFY command (RdbALTER), 2-44
- Verify command file generated by RMU Extract command
 - parameters for, 1-241t
- Verifying database integrity, 1-738
 - generating a command procedure for, 1-240
- Version number
 - displaying information about, 1-672
- View
 - extracting definition of, 1-241
 - unloading from the database, 1-676

W

- Work load
 - extract, 1-244
- Workload statistics
 - collecting, 1-140
 - deleting, 1-184
 - displaying, 1-631
 - inserting, 1-272

X

- XOR recovery blocks
 - specifying frequency of
 - for .aj backup file, 1-107
 - for database backup file, 1-61
 - for optimized .aj file, 1-377

